

Yellow Book

Acura

Laforza

Renault

Alfa Romeo

Lancia

Sterling

Audi

Lotus

Triumph

BMW

Mercedes

Vauxhall

Delorean

MG

Volkswagen

Fiat

Porsche

Zimmer

Honda

Reliant

Miscellaneous



Transmission Fluid Protection & Conversion Products



MULTI-VEHICLE PROTECTANT/SUPPLEMENT

PT6000

- Smart Blend TRANSMULTI takes the guess work out of converting ATF's because it works in all Transmission Types except Full Time 4 and CVT applications.
- Prevents and instantly stops torque converter shudder
- Errors and maintains proper shifts
- Dramatically reduces wear on internal components
- Prevents overheating, foaming and oxidation
- Extends frictional stability and fluid change intervals



FULLY FORMULATED CVT FLUID

PT7100

- Suitable for use in ALL Continuously Variable Transmission (CVT) applications
- Optimized for excellent metal to metal friction performance
- Provides advanced wear protection, anti-shudder performance and oxidation stability
- Excellent low temperature stability for proper operation in cold weather conditions



ATF PROTECTANT

PT91001

- Prevents & Instantly Eliminates Torque Converter Lock-Up Shudder
- Prevents Overheating and Oxidation
- Keeps Valves & Governors Free
- Protects and Coats Gears & Pumps
- Extends Fluid Life

Also Available in a 2-Step Clean & Protect Kit

PT943005



HIGHLY FRICTION MODIFIED (HFM) SUPPLEMENT

PT90001

- Eliminates the Need for Multiple OEM Fluids
- Big Profit Increase, Save Money \$\$\$
- Prevents Overheating & Fluid Oxidation
- Keeps Valves & Governors Free
- Softens Hard Shifting & Extends Fluid Life
- Prevents Torque Converter Lock Up Shudder



FLUID FLUSH

PT94200

- Safely Removes Light Varnish and Other Deposits
- Prepares Transmission for New Fluid
- Cleans All Internal Transmission Components
- Contains No Alcohol or Damaging Chemicals (Totally Safe)

M-V SUPPLEMENT

PT90000

- Converts Dexron III® /Mercon® Automatic Transmission Fluid (ATF) into a Mercon V® Type Fluid.
- Saves Time & Money, Eliminates the Need to Stock Mercon V® Fluid.
- Prevents Torque Converter Lock-Up Shudder.
- Improves Low Temperature Shifting.
- Extends Frictional Stability and Life of the Fluid.



SHUDDER ELIMINATOR

PT90000

- Instantly Eliminates Torque Converter Shudder
- Restores Key Friction Modifiers Lost Due to Heat and Excessive Mileage



D-VI SUPPLEMENT

PT94700

- Converts Dexron III® /Mercon® Automatic Transmission Fluid (ATF) into a Highly Stable Fluid such as DEXRON VI®.
- Converts Dexron III® /Mercon® Fluid to Stock Dexron III® /Mercon® Fluid
- Eliminates Torque Converter Shudder Instantly
- Improves Frictional Stability and Fluid Life.
- Creates Longer Service Intervals.
- Softens Hard Shifts.

CONTENT INDEX

TRANSMISSION	TYPE		SERIES	PAGE
Honda 2-Speed	2 SPD	FWD	50000	2
Honda 3-Speed	3 SPD	FWD	50000C	4
003	3 SPD	Trans-Axle	40000	6
010•087•089•090	3 SPD	Trans-Axle	40000C	8
MB-1•MJ3	3 SPD	FWD	71000	12
4139	3 SPD	FWD	71000M	14
4141	3 SPD	FWD	71000G	16
AK•AS•CA•F4•L4•ML4A•K4•PY8A•MY8A•PF4	4 SPD	FWD/AWD	50000D/E/G/K/L/M	18
Sterling 4-Speed	4 SPD	FWD	50000F	22
RO•MPRA•MP7A•SP7A•S4XA•SKWA	4 SPD	FWD	50000A/P	24
CA•P1•G4•L5•PL5X	4 SPD	FWD	50000F/S	28
APXA•APX4•MPXA•MPWA•MPOA•AOYA•BOYA•BAXA•MAXA•MP1A•M6HA•MPJA •MDWA•PX4B	4 SPD	FWD	50000N/R	32
A6VA•B6VA	4 SPD	FWD	50000N/R	36
M7ZA•B7VA•B7ZA	4 SPD	FWD	50000J/JA/Q	40
B7XA•MPZA•B7TA•B7YA	4 SPD	FWD	50000B/BA/Q	42
MPYA•M5HA•M5DA	4 SPD	FWD	50000T	46
MPWA•M1WA	4 SPD	FWD	50000Y	50
A4RA•B4RA•B46A•M4RA•BMXA•SLXA•BDRA	4 SPD	FWD	50000V	52
MDLA•A2YA•A24A•M24A•S24A•M4TA•MDMA	4 SPD	FWD	50000W/X	54
MR9A	4 SPD	RWD	50000U	58
S5	4 SPD	AWD	60183-	60
BZKA•MRVA•MCVA•BZNA	4 SPD	FWD/AWD	60184-	62
AG4•095•096•01M	4 SPD	FWD	93000	64
097•01N	4 SPD	FWD	92000	70
098•01P	4 SPD	FWD	97000	74
ZF4HP18-FL•FLA•FLE	4 SPD	FWD	83000	78
ZF4HP18Q	4 SPD	FWD	86000	82
MZKA	4/5 SPD	FWD/4x4	60185-	84
BGFA•MGFA	5 SPD	FWD	25164-	86
MJBA	5 SPD	FWD	25174-	88
BGHA•MGHA	5 SPD	AWD	25165-	90
BDKA•MDKA	5 SPD	AWD	25166-	92
BWEA	5 SPD	AWD	25168-	94
MRMA	5 SPD	FWD	25175-	96
M7WA•B7WA	5 SPD	FWD	25171-	98
BDGA	5 SPD	FWD	25167-	100
MCTA	5 SPD	FWD	25172-	102
MCLA	5 SPD	FWD	60197-	104
BAYA•MAYA	5 SPD	FWD	60187-	106
BYFA	5 SPD	AWD	25169-	108
BDHA	5 SPD	FWD	25170-	110
MURA	5 SPD	FWD	60203-	112
MKYA•BZHA•BZJA	5 SPD	AWD	60198-	114
MKZA	5 SPD	AWD	60199-	116
MNZA	5 SPD	FWD	60201-	118
SMMA•SP5A	5 SPD	FWD	60211-	120
BYBA	5 SPD	FWD	60193-	122
BGRA•PGRA	5 SPD	FWD	60188-	124
BVGA	5 SPD	AWD	60191-	126
BVLA	5 SPD	FWD	60192-	128
PVGA	5 SPD	AWD	60206-	130
PVLA	5 SPD	FWD	60207-	132
BJFA•MJFA	5 SPD	AWD	60189-	134
SPCA	5 SPD	FWD	60208-	136

CONTENT INDEX

INDEX

TRANSMISSION	TYPE		SERIES	PAGE
MZJA	5 SPD	FWD	60205-	138
MZHA	5 SPD	AWD	60204-	140
B97A	5 SPD	FWD	60259-	142
BCLA	5 SPD	FWD	60190-	144
GPLA	5 SPD	FWD	60194-	146
GPPA	5 SPD	AWD	60195-	148
MPCA	5 SPD	FWD	60202-	150
P34A	5 SPD	AWD	60257	152
P35A	5 SPD	FWD	60258-	154
09A•JF506E•5F31J	5 SPD	FWD/AWD	96221-	156
TF-60SN•09G•09K•09M•TF-62SN•6F21A	6 SPD	FWD/AWD	96247-	162
02E•DSG•DQ25	6 SPD	FWD/AWD	96252-	168
ZF6HP26A•09E	6 SPD	FWD/AWD	40280-	170
62TE	6 SPD	FWD/AWD	20161-	174
M4VA	CVT	FWD	50000Z	180
SZCA	CVT	FWD	60212-	182
MHTA	CVT	FWD	60200-	184
SPSA	CVT	FWD	60209-	186
SMLA	CVT	FWD	60210-	188
MLYA	CVT	FWD	60255-	190
SLYA	CVT	FWD	60256-	192
CFT23•25•27•ZF VT1F	CVT	FWD	45179-	194
01J (Multitronic)	CVT	FWD	40176-	196
ZF3HP12•20	3 SPD	RWD	56000	200
ZF3HP22	3 SPD	RWD	56000A	202
772.0•772.2	3 SPD	RWD	55000	204
FMX•CW•BW8•BW12•R12	3 SPD	RWD	600M/N/V/W	206
BW35•T35•BW35TB•37TB•BW65•66	3 SPD	RWD	19000/47000/58000	210
C3	3 SPD	RWD/4x4	27000	214
C4•C5	3 SPD	RWD/4x4	26000/M	218
ZF4HP22•24-A	4 SPD	RWD/AWD	56000D/E/M	224
TH180•C•4L30-E	4 SPD	RWD/4x4	41000/E	228
722.3•722.4	4/5 SPD	RWD	55000A/E	234
A4LD•4R44E•4R55E•5R55E	4/5 SPD	RWD/4x4	27000D/E/G/H	238
ZF5HP18	5 SPD	RWD	56000F	246
ZF5HP19-FL•FLA•01V•01L	5 SPD	RWD/FWD/AWD	87000/B	248
ZF5HP24•A•ZF5HP22	5 SPD	AWD/4x4	56000G/J	252
ZF5HP30	5 SPD	RWD	56000H	254
4L40E•5L40E•50E	5 SPD	RWD/AWD	60000	256
722.6•W5A580•W5A330	5 SPD	RWD/AWD	78223-	262
722.5	5 SPD	RWD	55000F	270
ZF6HP19	6 SPD	RWD/AWD	45178-	272
ZF6HP26	6 SPD	RWD	45158-	274
ZF6HP32	6 SPD	AWD	40177-	280
ZF6HP21	6 SPD	RWD/AWD	45180-	282
09D•TR60SN	6 SPD	AWD	96260-	284
6L45E•6L50E	6 SPD	RWD/AWD	10155-	288
722.9	7 SPD	RWD/AWD	78225-	292
BT3A	5 SPD	FWD	25276-	297
B90A	5 SPD	FWD	60186-	298
M91A	5 SPD	FWD	60196-	299
P36A•B36A	5 SPD	FWD	60272-	300
PN3A	5 SPD	AWD	60273-	301
PN4A	5 SPD	FWD	60274-	302

CONTENT INDEX

TRANSMISSION	TYPE		SERIES	PAGE
PSFA	5 SPD	AWD	60275-	303
BK3A•BK4A	5 SPD	FWD/AWD	25277-	304
MM7A	5 SPD	FWD	25278-	305
MM2A	5 SPD	FWD	25279-	306
722.7	7 SPD	FWD	78224-	296

NOTES

INDEX

VEHICLE TO TRANSMISSION INDEX

INDEX

MODEL NAME	ENGINE	YEAR	TRANSMISSION	PAGE
ACURA				
CL	V/6 3.0L	96-99	M7ZA•B7VA•B7ZA	40
CL	L/4 2.2L	96-97	A6VA•B6VA	36
CL	V/6 3.0L	96-99	M7ZA•B7VA•B7ZA	40
CL	L/4 2.3L	98-99	A6VA•B6VA	36
CL	V/6 3.2L	01-03	BGFA•MGFA	86
Integra	L/4 1.6L	86-89	CA•P1•G4•L5•PL5X	28
Integra	L/4 1.8L	90-90	RO•MPRA•MP7A•SP7A•S4XA•SKWA	24
Integra	L/4 1.8L	91-93	RO•MPRA•MP7A•SP7A•S4XA•SKWA	24
Integra	L/4 1.8L	94-99	RO•MPRA•MP7A•SP7A•S4XA•SKWA	24
Integra	L/4 1.8L	00-00	RO•MPRA•MP7A•SP7A•S4XA•SKWA	24
Legend	V/6 2.5L	86-87	CA•P1•G4•L5•PL5X	28
Legend	V/6 2.7L	87-89	CA•P1•G4•L5•PL5X	28
Legend	V/6 2.7L/3.2L	91-95	MPYA•M5HA•M5DA	46
MDX	V/6 3.5L	01-02	BGHA•MGHA	90
MDX	V/6 3.5L	03-06	BDKA•MDKA	92
MDX	V/6 3.5L	05-07	BDKA•MDKA	92
MDX	V/6 3.7L	07-11	BYFA	108
NSX	V/6 3.0L/3.2L	91-05	MR9A	58
RDX	L/4 2.3L	07-11	BWEA	94
RDX	L/4 2.3L	10-11	BT3A	297
RL	V/6 3.5L	96-03	MPYA•M5HA•M5DA	46
RL	V/6 3.2L	01-05	M7WA•B7WA	98
RL	V/6 3.5L	05-09	MJBA	88
RSX	L/4 2.0L	02-06	MRMA	96
SLX	V/6 3.2L/3.5L	96-99	TH180•C•4L30-E	228
TL	L/5 2.5L	95-98	MPWA•M1WA	50
TL	V/6 3.2L	96-98	MPYA•M5HA•M5DA	46
TL	V/6 3.2L	99-99	M7ZA•B7VA•B7ZA	40
TL	V/6 3.2L	00-03	M7WA•B7WA	98
TL	V/6 3.2L	04-07	BDGA	100
TL Type S	V/6 3.5L	07-08	BDHA	110
TL Type S	V/6 3.5L/3.7L	09-11	BK3A•BK4A	304
TSX	L/4 2.4L	04-11	MCTA	102
TSX	L/4 2.4L	09-11	MM7A	305
TSX	V/6 3.5L	10-11	MM2A	306
Vigor	L/5 2.5L	91-94	MPWA•M1WA	50
ALFA ROMEO				
164	n/a	91-95	ZF4HP18Q	82
All 3 Speeds	n/a	71-76	ZF3HP12•20	200
All 3 Speeds	various	76-78	ZF3HP22	202
All 4 Speeds	n/a	84-95	ZF4HP22•24-A	224
Spider	n/a	91-94	ZF3HP22	202
AUDI				
100	n/a	70-75	003	6
100	L/5 2.3L	77-94	010•087•089•090	8
100	L/4 1.9L	85-94	010•087•089•090	8
100	V/6 2.6L/2.8L	89-97	ZF4HP18-FL•FLA•FLE	78
100	L/5 2.3L/2.8L	90-94	097•01N	70
100 Quattro	V/6 2.8L	92-94	ZF4HP18-FL•FLA•FLE	78
200	L/5 2.2L	84-91	010•087•089•090	8
200	V/6 2.6L/2.8L	89-97	ZF4HP18-FL•FLA•FLE	78
4 Avant	V/6 2.7L	01-02	ZF5HP19-FL•FLA•01V•01L	248
4000	L/5 2.1L	80-87	010•087•089•090	8

VEHICLE TO TRANSMISSION INDEX

MODEL NAME	ENGINE	YEAR	TRANSMISSION	PAGE
4000	L/4 1.6L/1.7L/1.8L	80-87	010•087•089•090	8
5000	L/5 2.1L/2.2L/2.3L	78-88	010•087•089•090	8
80	L/5 2.3L	85-91	010•087•089•090	8
80	L/4 2.0L	91-92	010•087•089•090	8
80, Avant	L/5 2.3L	91-96	097•01N	70
90	L/5 2.3L	85-91	010•087•089•090	8
90	L/5 2.3L V/6 2.6L/2.8L	91-95	097•01N	70
A3	L/4 2.0L V/6 3.2L	06-07	TF-60SN•09G•09K•09M•TF-62SN•6F21A	162
A3	L/4 2.0L V/6 3.2L	06-07	02E•DSG•DQ25	168
A4	L/4 1.8L V/6 2.8L/3.0L	95-04	ZF5HP19-FL•FLA•01V•01L	248
A4	L/4 1.6L/1.8L/1.9L	95-98	097•01N	70
A4	L/4 2.0L	06-07	TF-60SN•09G•09K•09M•TF-62SN•6F21A	162
A4 Avant	L/4 1.8L V/6 2.8L/3.0L	98-05	ZF5HP19-FL•FLA•01V•01L	248
A4, Cabriolet	L/4 1.8L V/6 3.0L	04-11	01J (Multitronic)	196
A4, Cabriolet, Quattro	L/4 1.8L V/6 3.0L	03-06	ZF5HP19-FL•FLA•01V•01L	248
A4, Cabriolet, Quattro	L/4 2.0L/V/6 3.1L	06-07	ZF6HP26A•09E	170
A6	V/6 2.8L	95-96	ZF4HP18-FL•FLA•FLE	78
A6	V/6 2.7L/2.8L/3.0L	97-04	ZF5HP19-FL•FLA•01V•01L	248
A6	V/8 4.2L	97-04	ZF5HP19-FL•FLA•01V•01L	248
A6	V/6 3.0L	02-11	01J (Multitronic)	196
A6 Quattro	V/8 4.2L	95-97	ZF4HP22•24-A	224
A6 Quattro	V/6 2.8L	95-97	ZF4HP18-FL•FLA•FLE	78
A6 Quattro	V/8 4.2L	98-04	ZF5HP24•A•ZF5HP22	252
A6 Quattro	V/6 3.1L V/8 4.2L	05-07	ZF6HP26A•09E	170
A6 Quattro,A6 Allroad	V/6 2.7L/2.8L/3.0L	98-04	ZF5HP19-FL•FLA•01V•01L	248
A6 Quattro,A6 Allroad	V/8 4.2L	98-04	ZF5HP19-FL•FLA•01V•01L	248
A6, Avant	V/6 2.5L/2.6L/2.8L	94-97	ZF4HP18-FL•FLA•FLE	78
A6, Avant	L/5 2.3L V/6 2.6L/2.8L	94-94	097•01N	70
A6, Avant	L/4 1.9L/2.0L V/6 2.6L	95-98	097•01N	70
A8	V/6 2.8L	94-99	ZF4HP18-FL•FLA•FLE	78
A8	V/6 2.5L/2.8L/3.7L	94-03	ZF5HP19-FL•FLA•01V•01L	248
A8	V/8 4.2L	94-03	ZF5HP19-FL•FLA•01V•01L	248
A8	V/8 4.0L/4.2L	03-10	ZF6HP26A•09E	170
A8	V10 5.2L V12 6.0L	03-10	ZF6HP26A•09E	170
A8 Quattro	V/8 4.2L	94-99	ZF4HP22•24-A	224
A8 Quattro	V/6 2.5L/2.8L/3.7L	95-95	ZF5HP19-FL•FLA•01V•01L	248
A8 Quattro	V/6 2.8L	95-95	ZF4HP18-FL•FLA•FLE	78
A8 Quattro	V/8 4.2L	99-03	ZF5HP24•A•ZF5HP22	252
A8 Quattro	V/8 4.2L	04-07	ZF6HP26A•09E	170
A8 Quattro	W/12 6.0L	04-07	ZF6HP32	280
Allroad Quattro	V/6 2.7L V/8 4.2L	02-05	ZF5HP19-FL•FLA•01V•01L	248
Cabriolet	L/4 1.6L/1.8L/1.9L	92-98	097•01N	70
Cabriolet	V/6 2.8L	94-98	097•01N	70
Coupe	L/5 2.1L/2.2L	81-87	010•087•089•090	8
Fox	n/a	73-75	003	6
S4, Avant	V/6 2.7L	01-02	ZF5HP19-FL•FLA•01V•01L	248
S4, Avant	V/8 4.2L	04-06	ZF6HP26A•09E	170
S6 Avant, RS6	V/8 4.2L	02-03	ZF5HP24•A•ZF5HP22	252
S6 Avant, RS6	V10 5.2L	07-08	ZF6HP26A•09E	170
S8	V10 5.2L	07-09	ZF6HP26A•09E	170
TT	L/4 1.8L V/6 3.0L	03-07	TF-60SN•09G•09K•09M•TF-62SN•6F21A	162
TT Quattro	V/6 3.2L	04-07	ZF6HP26A•09E	170
V8 Quattro	V/6 3.6L V/8 4.2L	89-94	ZF4HP22•24-A	224

INDEX

VEHICLE TO TRANSMISSION INDEX

INDEX

MODEL NAME	ENGINE	YEAR	TRANSMISSION	PAGE
BMW				
3 Series (E46)	L/6 2.5L	97-03	ZF5HP19-FL•FLA•01V•01L	248
3-Speeds	n/a	66-76	ZF3HP12•20	200
3-Speeds	various	73-76	BW35•T35•BW35TB•37TB•BW65•66	210
3-Speeds	n/a	76-83	ZF3HP12•20	200
318i	L/4 1.8L/1.9L	91-99	TH180•C•4L30-E	228
320i	V/8 3.0L	93-94	ZF5HP18	246
323i	L/6 2.5L	97-99	TH180•C•4L30-E	228
323i	L/6 2.5L	00-00	4L40E•5L40E•50E	256
325i	L/6 2.5L	92-95	TH180•C•4L30-E	228
325i/325ci	L/6 2.5L	04-04	ZF5HP19-FL•FLA•01V•01L	248
325i/325ci/325xi	L/6 2.5L	01-07	4L40E•5L40E•50E	256
325i/325xi	L/6 3.0L	06-07	ZF6HP19	272
328i	L/6 2.8L	96-99	TH180•C•4L30-E	228
328i	L/6 2.8L	00-00	4L40E•5L40E•50E	256
330i	L/6 3.0L	06-07	ZF6HP19	272
330i/330ci/330xi	L/6 3.0L	01-06	4L40E•5L40E•50E	256
4-Speeds	n/a	84-94	ZF4HP22•24-A	224
5 Series (E39)	L/6 2.5L	95-96	ZF5HP24•A•ZF5HP22	252
5 Series (E39)	L/6 2.5L	97-03	ZF5HP19-FL•FLA•01V•01L	248
5 Series (E39)	L/6 2.5L/3.0L V/8 4.4L/4.8L	04-10	ZF6HP26A•09E	170
525i	L/5 2.5L	91-95	TH180•C•4L30-E	228
525i	L/6 2.5L/3.0L	91-95	4L40E•5L40E•50E	256
525i	L/6 2.5L	04-04	ZF5HP19-FL•FLA•01V•01L	248
525i	L/6 3.0L	07-09	6L45E•6L50E	288
525i/525xi	L/6 2.5L/3.0L	04-07	ZF6HP19	272
528i	L/6 2.8L	96-99	TH180•C•4L30-E	228
528i	L/6 2.8L	00-00	4L40E•5L40E•50E	256
530i	V/8 3.0L	93-95	ZF5HP18	246
530i	L/6 2.5L/3.0L	01-03	4L40E•5L40E•50E	256
530i/530xi	L/6 2.5L/3.0L	04-07	ZF6HP19	272
540i	V/8 4.0L/4.4L	91-95	ZF5HP30	254
540i	V/8 4.4L	96-02	ZF5HP24•A•ZF5HP22	252
545i	V/8 4.4L	04-06	ZF6HP26	274
645ci/645Li	V/8 4.4L	04-06	ZF6HP26	274
7 Series (E38)	V/8 4.4L	97-03	ZF5HP19-FL•FLA•01V•01L	248
7 Series (E38)	V/8 4.4L	97-00	ZF5HP24•A•ZF5HP22	252
7 Series (E38)	L/6 3.0L (Germany)	08-10	ZF6HP21	282
740i	V/8 4.0L/4.4L	92-95	ZF5HP30	254
740i	V/8 4.4L	96-01	ZF5HP24•A•ZF5HP22	252
745i/Li	V/8 4.4L	02-04	ZF6HP26	274
750i/750Li	V/8 4.8L	06-07	ZF6HP26	274
750Li	V/12 5.4L	95-01	ZF5HP30	254
760i/760Li	V/12 6.0L	04-08	ZF6HP32	280
8 Series (E31)	V/8 4.4L	95-00	ZF5HP24•A•ZF5HP22	252
840ci	V/8 4.4L	96-97	ZF5HP24•A•ZF5HP22	252
840ci/cia	V/8 4.0L/4.4L	92-99	ZF5HP30	254
850	various	76-83	ZF3HP22	202
850	V/12 5.0L	88-94	ZF4HP22•24-A	224
850	V/12 5.5L	95-97	ZF5HP30	254
M3	L/6 3.0L/3.2L	95-98	ZF5HP18	246
Mini Cooper	L/4 1.6L	02-09	CFT23•25•27•ZF VT1F	194
Mini Cooper/S	L/4 1.6L	04-07	TF-60SN•09G•09K•09M•TF-62SN•6F21A	162
X3	L/6 2.5L/3.0L	04-07	4L40E•5L40E•50E	256

VEHICLE TO TRANSMISSION INDEX

MODEL NAME	ENGINE	YEAR	TRANSMISSION	PAGE
X3	L/4 2.0L (Austria)	07-10	ZF6HP21	282
X5	L/6 2.5L/3.0L	00-07	4L40E•5L40E•50E	256
X5	V/8 4.4L/4.6L	00-07	4L40E•5L40E•50E	256
X5	V/8 4.4L/4.8L	04-07	ZF6HP26A•09E	170
X5	L/6 3.0L	06-09	ZF6HP19	272
X5	L/6 3.0L	08-11	ZF6HP21	282
X6	L/6 3.0L V/8 4.4L	07-10	ZF6HP26	274
Z3/Z3 Roadster	L/4 1.9L L/6 2.8L	96-00	TH180•C•4L30-E	228
Z4 Roadster	L/6 2.5L/3.0L	01-07	4L40E•5L40E•50E	256
Z4 Roadster	L/6 2.5L/3.0L/3.2L	06-08	ZF6HP19	272
DELOREAN				
Delorean	various	81-86	4141	16
Delorean	various	81-82	TH180•C•4L30-E	228
FIAT				
124	various	71-83	TH180•C•4L30-E	228
130-3.2	V/6 3.2L (Mirafiori)	72-77	FMX•CW•BW8•BW12•R12	206
131	various	75-78	TH180•C•4L30-E	228
2300 Series	various	66-71	BW35•T35•BW35TB•37TB•BW65•66	210
Brava	various	75-81	TH180•C•4L30-E	228
Spider 2000	various	81-82	TH180•C•4L30-E	228
Strada	various	79-81	010•087•089•090	8
X 1/9	various	76-82	010•087•089•090	8
HONDA				
Accord	L/4 1.6L/1.8L	76-79	Honda 2-Speed	2
Accord	L/4 1.8L	80-82	Honda 3-Speed	4
Accord	L/4 1.8L F. I.	83-87	AK•AS•CA•F4•L4•ML4A•K4•PY8A•MY8A•PF4	18
Accord	L/4 1.8L Carb./F.I..	83-85	AK•AS•CA•F4•L4•ML4A•K4•PY8A•MY8A•PF4	18
Accord	L/4 1.8L Carb	84-85	AK•AS•CA•F4•L4•ML4A•K4•PY8A•MY8A•PF4	18
Accord	L/4 2.0L F. I.	86-89	AK•AS•CA•F4•L4•ML4A•K4•PY8A•MY8A•PF4	18
Accord	L/4 2.2L	90-90	APXA•APX4•MPXA•MPWA•MPOA•AOYA•BOYA• BAXA•MAXA•MP1A•M6HA•M PJA•MDWA•PX4B	32
Accord	L/4 2.2L USA	91-92	APXA•APX4•MPXA•MPWA•MPOA•AOYA•BOYA• BAXA•MAXA•MP1A•M6HA•M PJA•MDWA•PX4B	32
Accord	L/4 2.2L Japan	91-91	APXA•APX4•MPXA•MPWA•MPOA•AOYA•BOYA• BAXA•MAXA•MP1A•M6HA•M PJA•MDWA•PX4B	32
Accord	L/4 2.2L Japan	92-92	APXA•APX4•MPXA•MPWA•MPOA•AOYA•BOYA• BAXA•MAXA•MP1A•M6HA•M PJA•MDWA•PX4B	32
Accord	L/4 2.2L	94-97	APXA•APX4•MPXA•MPWA•MPOA•AOYA•BOYA• BAXA•MAXA•MP1A•M6HA•M PJA•MDWA•PX4B	32
Accord	V/6 2.7L	95-97	B7XA•MPZA•B7TA•B7YA	42
Accord	L/4 2.3L USA	98-02	APXA•APX4•MPXA•MPWA•MPOA•AOYA•BOYA• BAXA•MAXA•MP1A•M6HA•M PJA•MDWA•PX4B	32
Accord	L/4 2.3L Japan	98-02	APXA•APX4•MPXA•MPWA•MPOA•AOYA•BOYA• BAXA•MAXA•MP1A•M6HA•M PJA•MDWA•PX4B	32
Accord	V/6 3.0L	98-02	B7XA•MPZA•B7TA•B7YA	42
Accord	V/6 3.0L	03-06	BAYA•MAYA	106
Accord	L/4 2.4L USA	03-07	MCLA	104
Accord	L/4 2.4L	03-07	BCLA	144
Accord	V/6 3.0L	07-11	B97A	142
Accord	L/4 2.3L	08-11	B90A	298
Accord	L/4 2.3L	08-11	M91A	299
Accord Hybrid	V/6 3.0L	05-07	MURA	112
Accord Wagon	L/4 2.2L	91-91	APXA•APX4•MPXA•MPWA•MPOA•AOYA•BOYA• BAXA•MAXA•MP1A•M6HA•M PJA•MDWA•PX4B	32
Civic	L/4 1.2L/1.5L	73-80	Honda 2-Speed	2
Civic	L/4 1.3L/1.5L	81-85	Honda 3-Speed	4
Civic	L/4 1.5L	86-87	AK•AS•CA•F4•L4•ML4A•K4•PY8A•MY8A•PF4	18
Civic	L/4 1.6L	89-90	AK•AS•CA•F4•L4•ML4A•K4•PY8A•MY8A•PF4	18

VEHICLE TO TRANSMISSION INDEX

INDEX

MODEL NAME	ENGINE	YEAR	TRANSMISSION	PAGE
Civic	L/4 1.6L	89-90	S5	60
Civic	L/4 1.5L/1.6L	92-95	MDLA•A2YA•A24A•M24A•S24A•M4TA•MDMA	54
Civic	L/4 1.6L	96-96	A4RA•B4RA•B46A•M4RA•BMXA•SLXA•BDRA	52
Civic	L/4 1.6L	97-98	A4RA•B4RA•B46A•M4RA•BMXA•SLXA•BDRA	52
Civic	L/4 1.6L	99-00	A4RA•B4RA•B46A•M4RA•BMXA•SLXA•BDRA	52
Civic	L/4 1.6L	01-06	A4RA•B4RA•B46A•M4RA•BMXA•SLXA•BDRA	52
Civic	L/4 1.6L	06-10	MPCA	150
Civic HX	L/4 1.6L	96-00	M4VA	180
Civic HX/GX	L/4 1.7L	01-02	MLYA	190
Civic HX/GX	L/4 1.7L	05-11	SLYA	192
Civic Hybrid	L/4 1.3L	03-05	SZCA	182
Civic Hybrid	L/4 1.3L	06-10	SPSA	186
Civic Hybrid	L/4 1.7L	06-07	SMLA	188
Civic/DX/EX/LX/GX	L/4 1.8L	06-10	SPCA	136
CR-V	L/4 2.0L/2.4L	97-04	MDLA•A2YA•A24A•M24A•S24A•M4TA•MDMA	54
CR-V	L/4 2.0L/2.4L	98-04	BZKA•MRVA•MCVA•BZNA	62
CR-V	L/4 2.4L	05-10	MKYA•BZHA•BZJA	114
CR-V	L/4 2.4L	05-06	MKZA	116
CR-V	L/4 2.0L	05-07	GPLA	146
CR-V	L/4 2.0L	05-07	GPPA	148
CR-V	L/4 2.4L	07-10	MZJA	138
CR-V	L/4 2.4L	07-10	MZHA	140
CRX	L/4 1.3L/1.5L	81-85	Honda 3-Speed	4
CRX	L/4 1.5L	86-87	CA•P1•G4•L5•PL5X	28
CRX	L/4 1.5L/1.6L	88-91	AK•AS•CA•F4•L4•ML4A•K4•PY8A•MY8A•PF4	18
Del Sol	L/4 1.6L	93-97	MDLA•A2YA•A24A•M24A•S24A•M4TA•MDMA	54
Element	L/4 2.4L	03-10	BZKA•MRVA•MCVA•BZNA	62
Element	L/4 2.4L	03-10	MZKA	84
Element	L/4 2.4L	07-10	MNZA	118
Fit	L/4 1.5L	07-10	SMMA•SP5A	120
Insight	L/3 1.0L	01-07	MHTA	184
Odyssey	L/4 2.2L/2.3L	95-98	APXA•APX4•MPXA•MPWA•MPOA•AOYA•BOYA•BAXA•MAXA•MP1A•M6HA•M PJA•MDWA•PX4B	32
Odyssey	V/6 3.5L	99-01	B7XA•MPZA•B7TA•B7YA	42
Odyssey	V/6 3.5L	02-04	BYBA	122
Odyssey	V/6 3.5L	05-08	BGRA•PGRA	124
Odyssey	3.5L V/6	07-11	P36A•B36A	300
Passport	L/4 2.6L V/6 3.2L	94-02	TH180•C•4L30-E	228
Pilot	V/6 3.5L	03-07	BVGA	126
Pilot	V/6 3.5L	06-07	BVLA	128
Pilot	V/6 3.5L	06-08	P34A	152
Pilot	V/6 3.5L	06-08	P35A	154
Pilot	V/6 3.5L	07-08	PVGA	130
Pilot	V/6 3.5L	07-08	PVLA	132
Pilot	V/6 3.5L	09-11	PN3A	301
Pilot	V/6 3.5L	09-11	PN4A	302
Prelude	L/4 1.8L	79-79	Honda 2-Speed	2
Prelude	L/41.8L	80-82	Honda 3-Speed	4
Prelude	L/4 1.8L Carb.	83-87	AK•AS•CA•F4•L4•ML4A•K4•PY8A•MY8A•PF4	18
Prelude	L/4 2.0L F.I.	85-87	AK•AS•CA•F4•L4•ML4A•K4•PY8A•MY8A•PF4	18
Prelude	L/4 2.0L	88-89	AK•AS•CA•F4•L4•ML4A•K4•PY8A•MY8A•PF4	18
Prelude	L/4 2.0L/2.1L	90-91	AK•AS•CA•F4•L4•ML4A•K4•PY8A•MY8A•PF4	18
Prelude	L/4 2.2L	92-01	APXA•APX4•MPXA•MPWA•MPOA•AOYA•BOYA•BAXA•MAXA•MP1A•M6HA•M PJA•MDWA•PX4B	32
Ridgeline	V/6 3.5L	06-08	BJFA•MJFA	134

VEHICLE TO TRANSMISSION INDEX

MODEL NAME	ENGINE	YEAR	TRANSMISSION	PAGE
Ridgeline	3.5L V/6	09-11	PSFA	303
LAFORZA				
Sport Truck	various	89-89	A4LD•4R44E•4R55E•5R55E	238
LANCIA				
Y9	various	76-80	ZF3HP22	202
LOTUS				
All	various	74-89	BW35•T35•BW35TB•37TB•BW65•66	210
MERCEDES				
190D	L/4 2.3L L/6 2.6L	84-89	722.3•722.4	234
190E	L/4 2.3L L/6 2.6L	84-93	722.3•722.4	234
240D	various	81-83	722.3•722.4	234
260E	various	87-89	722.3•722.4	234
300CD,D,SD,TD	L/5 2.5L L/6 2.6L/3.0L	85-85	722.3•722.4	234
300CD,SD,TD	L/5 2.5L L/6 2.6L/3.0L	81-85	722.3•722.4	234
300CE,TE	various	88-93	722.3•722.4	234
300D	various	81-87	722.3•722.4	234
300D,E	various	90-93	722.3•722.4	234
300E	various	86-93	722.3•722.4	234
300SD	various	92-93	722.3•722.4	234
300SDL	various	86-87	722.3•722.4	234
300SE	various	92-93	722.5	270
300SE,SEL	various	88-91	722.3•722.4	234
300SL	L/6 3.0L	90-93	722.5	270
300TD	various	87-87	722.3•722.4	234
350SD,SDL	various	90-91	722.3•722.4	234
380SE,SL	various	81-85	722.3•722.4	234
400E,SE,SEL	V/8 4.2L	92-93	722.3•722.4	234
420SEL	various	86-91	722.3•722.4	234
500E	V/8 5.0L	92-93	722.3•722.4	234
500SEC,SEL	various	84-85	722.3•722.4	234
500SEC,SEL	V/8 5.0L	92-93	722.3•722.4	234
500SL	V/8 5.0L	90-93	722.3•722.4	234
560SEC,SEL	various	86-91	722.3•722.4	234
560SL	various	86-88	722.3•722.4	234
600SEC,SEL,SL	various	92-93	722.3•722.4	234
All 3Spd w/4 bolt pan	various	70-81	772.0•772.2	204
C220	L/4 2.2L	94-96	722.3•722.4	234
C230	V/6 2.5L	06-07	722.7	296
C240	V/6 2.6L	02-05	722.6•W5A580•W5A330	262
C280	L/6 2.8L	94-96	722.3•722.4	234
C280	L/6 2.8L	97-07	722.6•W5A580•W5A330	262
C280	V/6 3.0L	06-06	722.6•W5A580•W5A330	262
C280	V/6 3.0L	06-06	722.7	296
C320	V/6 3.2L	00-05	722.6•W5A580•W5A330	262
C350	V/6 3.5L	06-06	722.6•W5A580•W5A330	262
C350	V/6 3.5L	06-06	722.7	296
C36	L/5 2.5L L/6 2.6L/3.0L	95-96	722.3•722.4	234
C36	L/6 3.6L	97-97	722.6•W5A580•W5A330	262
C43	V/8 4.3L	98-00	722.6•W5A580•W5A330	262
C55	V/8 5.5L	05-06	722.6•W5A580•W5A330	262
CL500	V/8 5.0L	98-04	722.6•W5A580•W5A330	262
CL500	V/8 5.0L	05-11	722.9	292
CL55 AMG	V/8 5.5L	01-09	722.6•W5A580•W5A330	262
CL600	V/12 5.5L/5.8L/6.0L	98-06	722.6•W5A580•W5A330	262

INDEX

VEHICLE TO TRANSMISSION INDEX

INDEX

MODEL NAME	ENGINE	YEAR	TRANSMISSION	PAGE
CL65 AMG	V/12 6.0L	05-09	722.6•W5A580•W5A330	262
CLK320	V/6 3.2L	98-05	722.6•W5A580•W5A330	262
CLK350	V/6 3.5L	06-07	722.7	296
CLK430	V/8 4.3L	99-03	722.6•W5A580•W5A330	262
CLK500	V/8 5.0L	03-04	722.6•W5A580•W5A330	262
CLK500	V/8 5.0L	05-11	722.9	292
CLK55 AMG	V/8 5.5L	01-09	722.6•W5A580•W5A330	262
CLS500	V/8 5.0L	05-11	722.9	292
CLS500 AMG	V/8 5.5L	06-07	722.6•W5A580•W5A330	262
E300	L/6 3.0L	95-96	722.3•722.4	234
E300	L/6 3.0L	97-99	722.6•W5A580•W5A330	262
E320	L/6 3.2L	94-96	722.3•722.4	234
E320	L/6 3.2L diesel	97-07	722.6•W5A580•W5A330	262
E320	V/6 3.2L	97-06	722.6•W5A580•W5A330	262
E350	V/6 3.5L	06-06	722.6•W5A580•W5A330	262
E350	V/6 3.5L	06-07	722.7	296
E420	V/8 4.2L	94-96	722.3•722.4	234
E500	V/8 5.0L	94-99	722.3•722.4	234
E500	V/8 5.0L	03-04	722.6•W5A580•W5A330	262
E500	V/8 5.0L 4X4	05-06	722.6•W5A580•W5A330	262
E500	V/8 5.0L	05-11	722.9	292
E55	V/8 5.5L	98-09	722.6•W5A580•W5A330	262
G500	V/8 5.0L	02-09	722.6•W5A580•W5A330	262
G55 AMG	V/8 5.5L	03-09	722.6•W5A580•W5A330	262
ML320	V/6 3.2L	98-02	722.6•W5A580•W5A330	262
ML350	V/6 3.7L	03-05	722.6•W5A580•W5A330	262
ML350	V/6 3.7L	06-07	722.7	296
ML430	V/8 4.3L	99-01	722.6•W5A580•W5A330	262
ML500	V/8 5.0L	02-05	722.6•W5A580•W5A330	262
ML500	V/8 5.0L	05-11	722.9	292
ML55	V/8 5.5L	00-03	722.6•W5A580•W5A330	262
R350	V/6 3.5L	06-07	722.7	296
R500	V/8 5.0L	05-11	722.9	292
S320	L/6 3.2L	94-95	722.5	270
S320	L/6 3.2L	96-99	722.6•W5A580•W5A330	262
S350	L/6 3.4L diesel	94-95	722.3•722.4	234
S350	V/6 3.7L	06-09	722.6•W5A580•W5A330	262
S420	V/8 4.2L	94-95	722.3•722.4	234
S420	V/8 4.2L	96-99	722.6•W5A580•W5A330	262
S430	V/8 4.3L	00-06	722.6•W5A580•W5A330	262
S430	V/8 4.3L	05-08	722.9	292
S500	V/8 5.0L	94-95	722.3•722.4	234
S500	V/8 5.0L	96-06	722.6•W5A580•W5A330	262
S500	V/8 5.0L	05-08	722.9	292
S55 AMG	V/8 5.5L	01-09	722.6•W5A580•W5A330	262
S600	V/12 6.0L	94-95	722.3•722.4	234
S600	V/12 5.5L/5.8L/6.0L	96-09	722.6•W5A580•W5A330	262
S65 AMG	V/12 6.0L	06-07	722.6•W5A580•W5A330	262
SL320	L/6 3.2L	94-97	722.5	270
SL500	V/8 5.0L	90-93	722.3•722.4	234
SL500	V/8 5.0L	96-03	722.6•W5A580•W5A330	262
SL500	V/8 5.0L	04-08	722.9	292
SL55 AMG	V/8 5.5L	03-06	722.6•W5A580•W5A330	262
SL600	V/12 6.0L	94-95	722.3•722.4	234

VEHICLE TO TRANSMISSION INDEX

MODEL NAME	ENGINE	YEAR	TRANSMISSION	PAGE
SL600	V/12 5.5L/6.0L	96-06	722.6•W5A580•W5A330	262
SL600 Roadster	V/12 5.5L	07-09	722.6•W5A580•W5A330	262
SL65 AMG	V/12 6.0L Bi-turbo	05-09	722.6•W5A580•W5A330	262
SLK230	L/4 2.3L V/6 3.2L	98-04	722.6•W5A580•W5A330	262
SLK280	V/6 3.0L	06-06	722.7	296
SLK32 AMG	V/6 3.2L	02-04	722.6•W5A580•W5A330	262
SLK350	V/6 3.5L	05-08	722.9	292
SLK55 AMG	V/8 5.5L	05-08	722.9	292
SLR McLaren	V/8 5.5L	05-09	722.6•W5A580•W5A330	262
MG				
British Leyand MGB-Roadster, GT	various	67-76	BW35•T35•BW35TB•37TB•BW65•66	210
Magnee MKIV	various	65-69	BW35•T35•BW35TB•37TB•BW65•66	210
Roadster, GT	various	76-79	BW35•T35•BW35TB•37TB•BW65•66	210
PORSCHE				
911	various	90-98	ZF4HP22•24-A	224
924, 944	various	76-91	010•087•089•090	8
928	various	78-82	772.0•772.2	204
928S,928GT,928GTS	various	83-95	722.3•722.4	234
944	various	91-94	ZF4HP18-FL•FLA•FLE	78
968	various	92-95	ZF4HP18-FL•FLA•FLE	78
Boxster	various	97-99	ZF5HP19-FL•FLA•01V•01L	248
RELIANT				
Scimitar GTE	V/6 3.0L	70-73	BW35•T35•BW35TB•37TB•BW65•66	210
Scimitar GTE	V/6 3.0L	74-80	C4•C5	218
Scimitar GTE	V/6 2.8L	75-82	C3	214
RENAULT				
Alliance	various	83-87	MB-1•MJ3	12
Encore	various	84-86	MB-1•MJ3	12
Fuego/18i	various	80-83	4139	14
Fuego/Sportswagon	various	84-86	MB-1•MJ3	12
Medallion	various	88-89	MB-1•MJ3	12
R12/R15/R17	various	73-79	4139	14
STERLING				
825/Coupe/Sedan	2.5L V/6	87-88	Sterling 4-Speed	22
827/Coupe/Sedan	2.7L V/6	89-91	Sterling 4-Speed	22
TRIUMPH				
1500 & 1725 P.B. Gas	various	73-76	BW35•T35•BW35TB•37TB•BW65•66	210
1500, 185D, 2000	various	73-80	BW35•T35•BW35TB•37TB•BW65•66	210
Acclaim	various	81-81	TH180•C•4L30-E	228
Stag	various	70-74	BW35•T35•BW35TB•37TB•BW65•66	210
Stag, Dolomite	various	74-77	BW35•T35•BW35TB•37TB•BW65•66	210
TR7, 2000, 2500	various	74-80	BW35•T35•BW35TB•37TB•BW65•66	210
TR7, TR8, Dolomite	various	81-81	BW35•T35•BW35TB•37TB•BW65•66	210
VAUXHALL				
Bedford CF van	various	70-87	TH180•C•4L30-E	228
Carlton	various	78-87	TH180•C•4L30-E	228
Carlton	various	90-94	TH180•C•4L30-E	228
Cavalier	various	75-91	TH180•C•4L30-E	228
Cresta PC	various	72-73	TH180•C•4L30-E	228
Victor/Viscount/VX series	various	69-78	TH180•C•4L30-E	228
Viva	various	69-80	TH180•C•4L30-E	228

VEHICLE TO TRANSMISSION INDEX

INDEX

MODEL NAME	ENGINE	YEAR	TRANSMISSION	PAGE
VOLKSWAGEN				
1500	various	69-75	003	6
1600	various	69-75	003	6
Beetle	various	69-75	003	6
Beetle	L/4 1.8L/1.9L/2.0L	94-04	AG4•095•096•01M	64
Beetle	L/4 1.9L L/5 2.5L	03-10	02E•DSG•DQ25	168
Beetle	L/4 1.8//2.0L diesel 1.9L L/5 2.5L	04-10	TF-60SN•09G•09K•09M•TF-62SN•6F21A	162
Beetle Convertible	L/4 1.9L L/5 2.5L	03-10	02E•DSG•DQ25	168
Cabrio	L/4 2.0L	95-01	AG4•095•096•01M	64
Cabriolet	L/4 1.8L	85-92	010•087•089•090	8
Camper	various	75-94	010•087•089•090	8
Corrado	L/4 1.8L V/6 2.8L	89-95	AG4•095•096•01M	64
Dasher	various	69-75	003	6
Dasher	various	75-94	010•087•089•090	8
EOS	L/4 2.0L V/6 3.2L	07-08	TF-60SN•09G•09K•09M•TF-62SN•6F21A	162
Eurovan	L/4 2.4L/2.5L	92-94	098•01P	74
Eurovan	V/6 2.8L	95-03	098•01P	74
Golf	L/4 1.8L/2.0L	85-92	010•087•089•090	8
Golf	L/4 1.8L/2.0L diesel 1.9L	93-10	AG4•095•096•01M	64
Golf	L/4 1.9L diesel	02-07	09A•JF506E•5F31J	156
Golf	L/4 1.9L diesel	04-06	09A•JF506E•5F31J	156
Golf	L/4 1.4L/1.9L/2.0L V/6 3.2L	05-11	02E•DSG•DQ25	168
GTI	L/4 1.8L/1.9L V/6 2.8L	99-01	AG4•095•096•01M	64
GTI	L/4 1.8L	02-07	09A•JF506E•5F31J	156
GTI	L/4 2.0L	06-07	TF-60SN•09G•09K•09M•TF-62SN•6F21A	162
GTI	L/4 2.0L	07-07	02E•DSG•DQ25	168
Jetta	L/4 1.6L/1.7L/1.8L	75-92	010•087•089•090	8
Jetta	L/4 1.8L/2.0L diesel 1.9L	93-94	AG4•095•096•01M	64
Jetta	L/4 2.0L V/6 2.8L	93-05	AG4•095•096•01M	64
Jetta	L/4 1.8L V/6 2.8L	02-03	09A•JF506E•5F31J	156
Jetta	L/4 2.0L diesel 1.9L	02-03	AG4•095•096•01M	64
Jetta	L/5 2.5L/2.0L diesel 1.9L	05-07	TF-60SN•09G•09K•09M•TF-62SN•6F21A	162
Jetta	L4 1.6L/1.9L/2.0L L5 2.5L	05-10	02E•DSG•DQ25	168
Jetta GLX	V/6 2.8L	94-98	AG4•095•096•01M	64
Jetta Wagon	L/5 1.8L diesel 1.9L	04-08	09A•JF506E•5F31J	156
Jetta Wagon	L/4 1.8L/1.9L diesel	04-05	09A•JF506E•5F31J	156
Jetta Wagon	L4 1.6L/1.9L/2.0L L5 2.5L	05-11	02E•DSG•DQ25	168
Kombi	various	75-88	010•087•089•090	8
Passat	L/4 2.0L V/6 2.8L	90-94	AG4•095•096•01M	64
Passat	L/4 2.0L V/6 2.8L	95-97	AG4•095•096•01M	64
Passat	L/4 1.8L V/6 2.8L V/8 4.0L	98-05	ZF5HP19-FL•FLA•01V•01L	248
Passat	L/4 1.8L/2.0L V/6 2.8L	02-04	ZF5HP19-FL•FLA•01V•01L	248
Passat	L/4 2.0L	06-07	TF-60SN•09G•09K•09M•TF-62SN•6F21A	162
Passat	V/6 3.6L	06-07	ZF6HP26A•09E	170
Phaeton	V/8 4.2L	04-05	ZF6HP26A•09E	170
Phaeton	W/12 6.0L	04-04	ZF5HP19-FL•FLA•01V•01L	248
Pickup	various	75-94	010•087•089•090	8
Quantum	L/5 2.2L	82-88	010•087•089•090	8
Quantum	L/4 1.6L/1.7L/1.8L	82-88	010•087•089•090	8
Rabbit	L/4 1.5L/1.6L/1.7L	80-84	010•087•089•090	8
Rabbit	L/5 2.5L	06-07	TF-60SN•09G•09K•09M•TF-62SN•6F21A	162
Rabbit	L/5 2.5L	06-07	02E•DSG•DQ25	168
Routan S/SE	V/6 3.8L 12 valves	09-11	62TE	174
Routan SEL/SEL Premium	V/6 4.0L 24 valves	09-11	62TE	174

Miscellaneous

ADVERTISERS	PRODUCTS	PAGE
Life Products	oil and oil additives	front cover
Transtec	gaskets/seals/rings	rear cover
Rostra	electrical products	11
Alto	frictions/steels	27
ATSG	repair manuals	31
Muscle	oil additives	35
LubeGard	oil and oil additives	39
Superior	valve body repair	45
Teckpak	speciality products	49
Loctite	sealants	57
Toledo	electrical and hard parts	69
GFX	hard parts and electrical	73
Filtran	rings/filters/grease	81
Sonnax	valve body repair and hard parts	161
Dacco	converters and hard parts	167
Conversion	engines	227
A & Reds	number system	233
A & Reds	engine hanger parts	237
A & Reds	engine hanger	251
A & Reds	speedo problems	269
A & Reds	decimal chart	295
A & Reds	disclaimer	307
BorgWarner	electrical and frictions	308

Honda 2-Speed

Honda 2-Speed

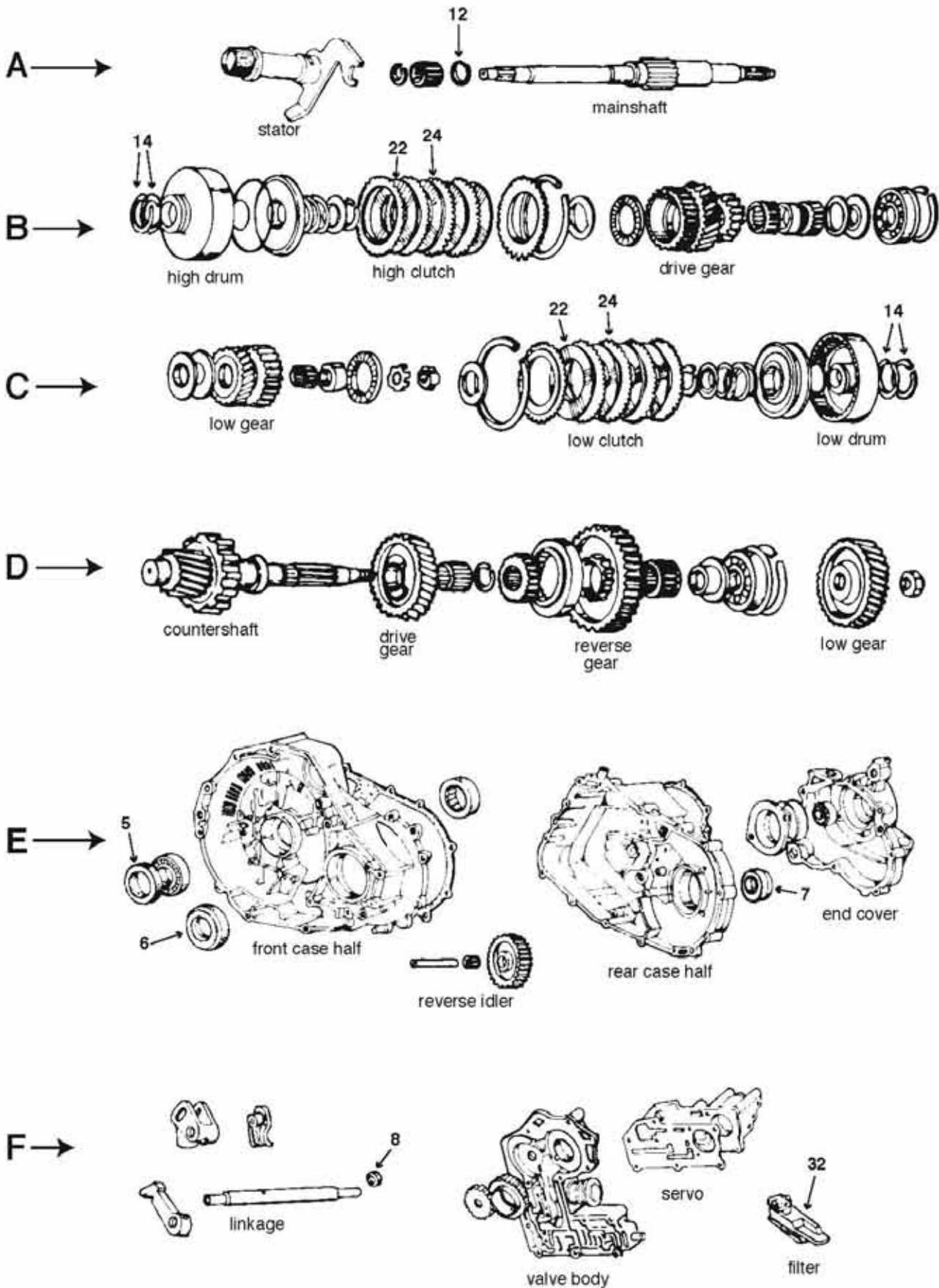

Honda 2-speed
50000

Honda 2-Speed

Honda 2-Speed

ILL	DESCRIPTION		QTY	YEAR	REFERENCE #	PART #
TECHNICAL MANUALS						
K53	Tech manual Honda 2 speed dis/assembly	diagnosis/troubleshooting	1	73-80	83-HDA2SPDTM	010-411
REBUILDER KITS						
K5	Master kit w/steels	Honda 2-speed	1	73-80	AE	K5000
K6	Master kit w/o steels	Honda 2-speed	1	73-80	AE	K5000-LS
K7	O/H gasket set w/seals-rings	Honda 2-speed	1	73-80	AE	K50900
METAL CLAD SEALS						
E5	Seal, metal clad 35x68x5mm	Honda 2-speed front seal	1	73-80	91207-639-015	50201
E6	Seal, metal clad 35x68x9mm	Honda 2-speed bell housing (axle)	1	73-80	91206-639-005	50200
E7	Seal, metal clad 35x56x9mm	Honda 2-speed case (axle)	1	73-80	91205-639-005	50202
F8	Seal, metal clad 12x22x7mm	Honda 2-speed lever seal	1	73-80	91209-612-003	46202
n/i	Seal, metal clad 16x7x6mm	Honda 2-speed speedo gear shaft	1	73-80	91208-515-015	50207
SEALING RINGS						
K10	Kit, sealing ring	Honda 2-speed	1	73-80	AE	K50300
A12	Ring, sealing 24mm	Honda 2-speed mainshaft	1	73-80	23122-639-003	50300
BC14	Ring, sealing 52mm	Honda 2-speed 2-drive/2-low	4	73-80	22628-639-003	50301
CLUTCH PLATES						
B22	Friction .075" 3.374" od 38T	high clutch	4	73-80	22535-639-010	50103
B24	Steel .079" 2.758" id 39T	high clutch	4	73-80	22536-639-000	50100
C22	Friction .075" 3.374" od 38T	low clutch	4	73-80	22535-639-010	50103
C24	Steel .079" 2.758" id 39T	low clutch	4	73-80	22536-639-000	50100
n/i	Steel .070" 2.758" id 39T (us)	high/low clutch	sel	73-80	APC-047701A	50102
FILTERS						
F32	Filter, oil screen	Honda 2-speed disassembly required	1	73-80	25420-639-000	50800
NOTES						

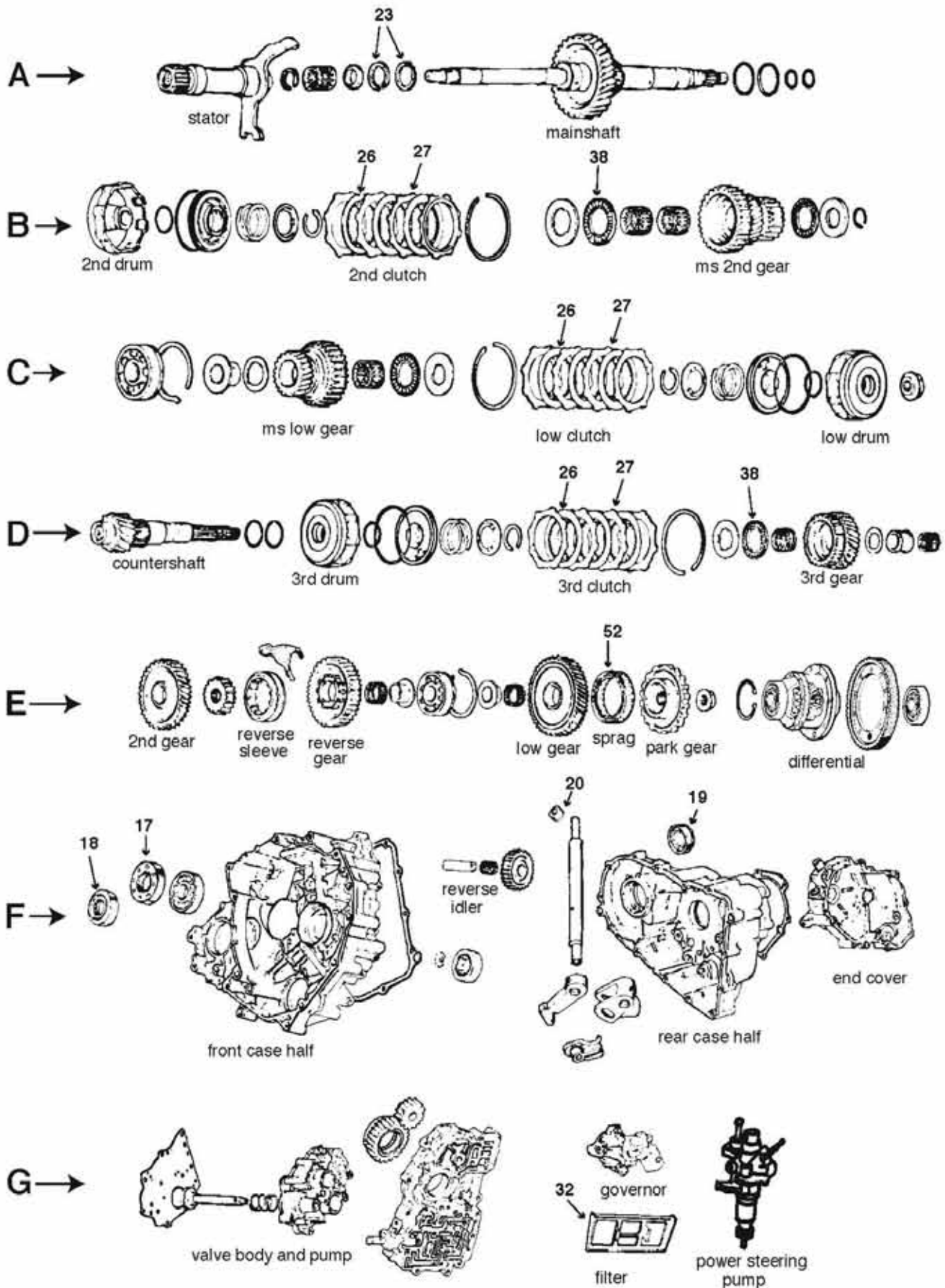

Honda 3-speed
50000C

A →

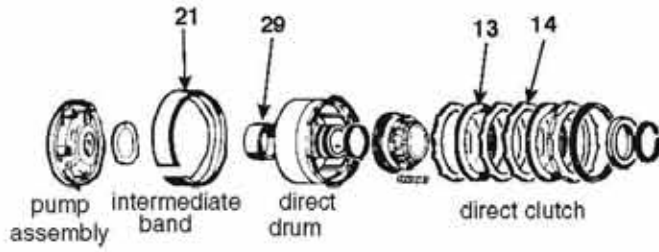

B →

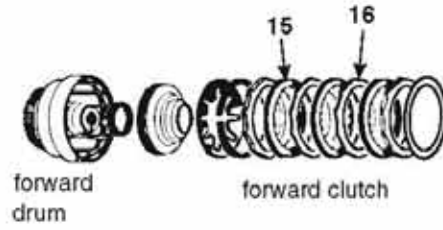

C →

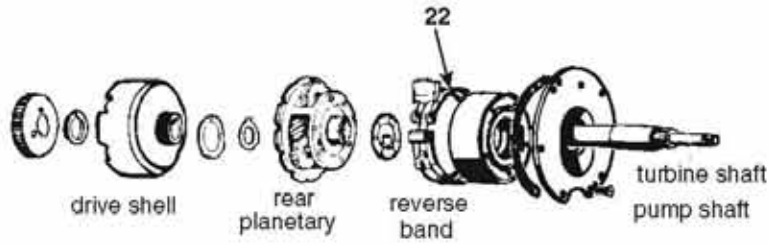

D →

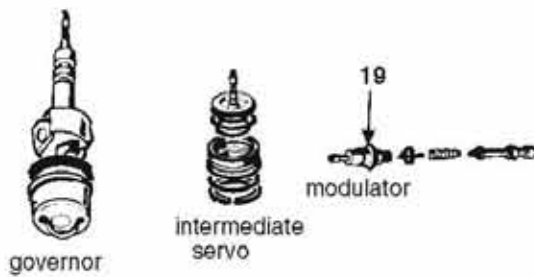

E →

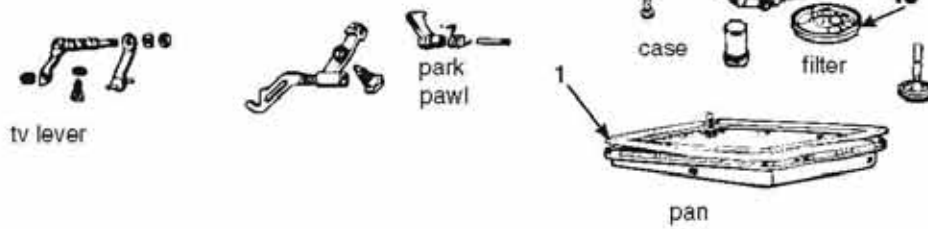

ILL	DESCRIPTION		QTY	YEAR	REFERENCE #	PART #
TECHNICAL MANUALS						
K53	Tech manual 003/010 dis/assembly	diagnosis/troubleshooting	1	69-76	83-003010TM	010-435
REBUILDER KITS						
K4	Master deluxe rebuild kit	VW003	1	69-76	AE	K4000-R
K5	Master kit w/steels	VW003	1	69-76	AE	K4000
K6	Master kit w/o steels	VW003	1	69-76	AE	K4000-LS
K7	O/H gasket set w/seals-rings	VW003	1	69-76	AE	K40900
K11	Gasket and seal kit	VW003	1	69-76	AE	K40900-1
GASKETS AND RUBBER COMPONENTS						
E1	Gasket, oil pan	neoprene/cork	1	69-76	003-321-371	13800X
E1	Gasket, oil pan	Duraprene®	1	69-76	003-321-371F	13800D
n/i	Gasket, final drive	VW003	1	69-76	003-507-275	13880
n/i	O'ring, governor cover and servo cover	VW003	2	69-76	003-325-381	13881
METAL CLAD SEALS						
n/i	Seal, metal clad	torque converter (front pump)	1	69-76	003-519-089A	40680
n/i	Seal, metal clad	final drive (axle)	2	69-76	003-507-269A	40205
n/i	Seal, metal clad	drive pinion	1	69-76	003-519-085A	40686
n/i	Seal, metal clad	governor shaft	1	69-76	003-507-125A	40682
SEALING RINGS						
K10	Kit, sealing ring	VW003	1	69-76	AE	K40300
n/i	Sealing ring	VW003	4	69-76	003-321-261	40300
CLUTCH PLATES						
A13	Friction .091" 4.146" od 43T	reverse clutch (Audi uses 3)	2/3	69-76	003-323-141	40102
A14	Steel .079" 3.527" id 16T	reverse clutch (Audi uses 4)	3/4	69-76	003-323-139	40105
B15	Friction .060" 4.156" od 43T	forward clutch (Audi uses 4)	3/4	69-76	003-323-241B	40104
B16	Steel .079" 3.527" id 16T	forward clutch (Audi uses 4)	2/3	69-76	003-323-139	40105
FILTERS						
K9	Kit, filter	VW003	1	69-76	AE	FK40800
E18	Filter, screen	VW003	1	69-76	003-325-421	40800
MODULATORS						
D19	Modulator, vacuum	VW003	1	69-76	003-325-391A	40820
BANDS						
A21	Band, 2nd gear	VW003	1	69-76	003-323-461	40700
C22	Band, low/reverse	wrap-type	1	69-76	003-323-411	40900-RL
BUSHINGS						
K13	Kit, bushing	VW003	1	69-76	AE	K40905
A29	Bushing	direct/reverse drum	1	69-76	003-323-115	40008
n/i	Bushing	oil pump body	1	69-76	003-321-253	40006
n/i	Bushing	oil pump gear	1	69-76	003-323-611	40004
n/i	Bushing	main shaft-stator support	1	69-76	003-519-073	40002
n/i	Bushing	torque converter hub	1	69-76	003-323-611	40004
n/i	Bushing	forward clutch hub	2	69-76	003-519-073	40002
n/i	Bushing	sun gear	1	69-76	003-323-289	40012
n/i	Bushing	annulus gear	1	90-06	003-323-373	40014
NOTES						

A →

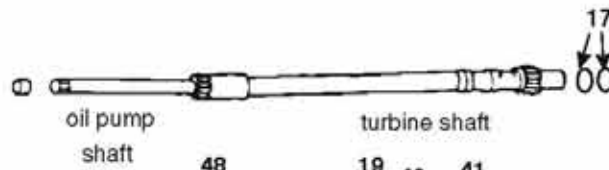

B →

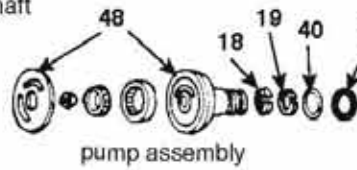

C →

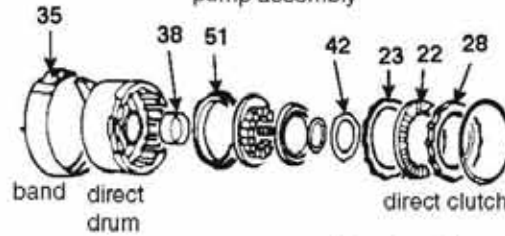

D →

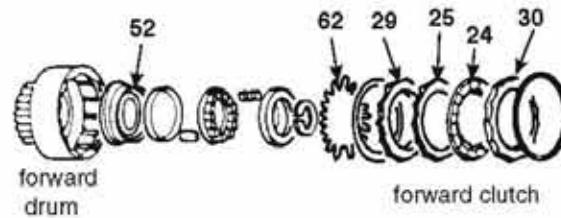

E →

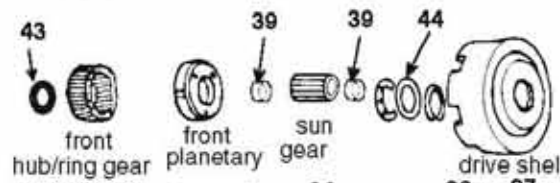

F →

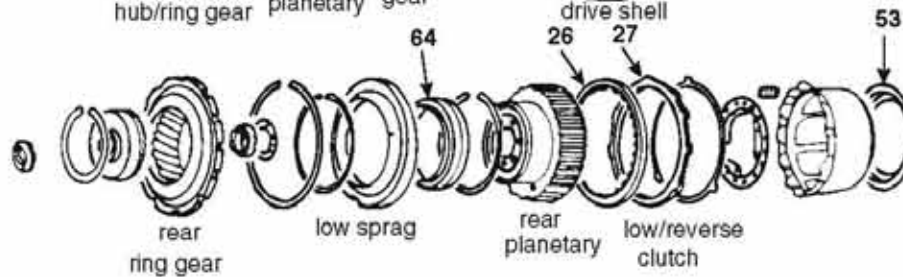

G →

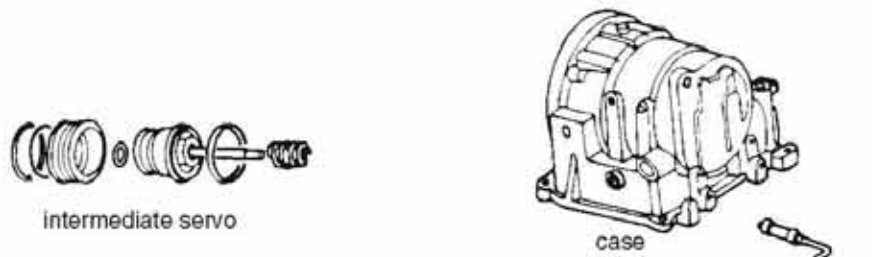

H →



010/087/089/090
40000C

ILL	DESCRIPTION		QTY	YEAR	REFERENCE #	PART #
TECHNICAL MANUALS						
K53	Tech manual 003/010 dis/assembly	diagnosis/troubleshooting	1	75-94	83-003010TM	010-435
REBUILDER KITS						
K4	Master deluxe rebuild kit	010	1	75-94	AE	K4000C-R
K4	Master deluxe rebuild kit	089/090	1	75-94	AE	K4000D-R
K4	Master deluxe rebuild kit	087	1	77-84	AE	K4000E-R
K4	Master deluxe rebuild kit	087	1	85-94	AE	K4000F-R
K5	Master kit w/steels	010	1	75-94	AE	K4000C
K5	Master Kit w/steels	089/090	1	75-94	AE	K4000D
K5	Master kit w/steels	087	1	77-84	AE	K4000E
K5	Master kit w/steels	087	1	85-94	AE	K4000F
K6	Master kit w/o steels	010	1	75-94	AE	K4000C-LS
K6	Master kit w/o steels	089/090	1	75-94	AE	K4000D-LS
K6	Master kit w/o steels	087	1	77-84	AE	K4000E-LS
K6	Master kit w/o steels	087	1	85-94	AE	K4000F-LS
K7	O/H gasket set w/seals-rings	010	1	75-94	AE	K40900C
K7	O/H gasket set w/seals-rings	089/090	1	77-94	AE	K40900D
K7	O/H gasket set w/seals-rings	087	1	77-94	AE	K40900E
K11	Gasket and seal kit	all	1	75-94	AE	K40900C-1
GASKETS AND RUBBER COMPONENTS						
H1	Gasket, pan	molded rubber	1	75-94	010-321-371B	13410R
H2	Gasket, filter	all	1	75-94	010-325-443	13801
n/i	Seal, lathe cut	10 1/2" final drive housing to case	1	75-94	010-409-549B	13620
METAL CLAD SEALS						
n/i	Seal, metal clad	converter housing (exc 090)	1	75-94	010-409-568	40201
n/i	Seal, metal clad	converter housing (090)	1	77-94	003-519-089D	40680
n/i	Seal, metal clad	axle shaft (except 010)	2	75-94	018-409-399	40205
n/i	Seal, metal clad axle shaft	axle shaft (010)	2	75-83	010-409-255	40204
n/i	Seal, metal clad axle shaft	axle shaft (010)	2	84-94	020-301-189M	40204A
n/i	Seal, metal clad	turbine shaft to pump shaft (not in kits)	1	84-94	087-323-559A	40213
n/i	Seal, metal clad	governor shaft (087/089)	1	77-94	087-409-133A	40206
n/i	Seal, metal clad	governor shaft (090)	1	77-94	003-507-125A	40682
n/i	Seal, metal clad	final drive, pinion front (010/090)	1	75-94	010-409-085D	40686
n/i	Seal, metal clad	final drive, pinion front (089)	1	75-94	089-409-085B	40207
n/i	Seal, metal clad	final drive, pinion front (087)	2	76-94	087-409-085A	40209
n/i	Seal, metal clad	final drive, pinion rear (010)	1	75-94	010-409-529C	40202
n/i	Seal, metal clad	final drive, pinion rear (089/090)	2	75-94	089-409-529A	40208
n/i	Seal, metal clad	final drive, pinion rear (087)	2	75-94	087-409-529A	40210
SEALING RINGS						
K10	Kit, sealing ring	all	1	75-94	AE	K40300C
A17	Sealing ring	input shaft	2	75-94	010-323-557A	40302
B18	Sealing ring	direct clutch	2	75-94	010-321-261	40301
B19	Sealing ring	forward clutch	2	75-94	003-321-261	40300
CLUTCH PLATES						
C22	Friction .090" 4.756" od 49T	direct/reverse clutch (010/089/090)	3/5	75-94	010-323-141B/C	40102C
C22	Friction .090" 5.000" od 49T	Audi 087 (direct/reverse clutch)	5	84-94	087-323-141/A	40102D
C23	Steel .079" 4.100" id 17T	direct/reverse clutch (010/089/090)	3/5	75-94	010-323-139/A	40100C
C23	Steel .079" 4.059" id 53T	Audi 087 (direct/reverse clutch)	5	84-94	087-323-139	40100D
D24	Friction. 061" 4.100" od 49T	forward clutch (all)	3/5	75-94	010-323-241/B/C	40104C
D25	Steel .079" 4.100" id 17T	forward clutch (all)	2/4	75-06	010-323-139/A	40100C
F26	Friction .061" 6.679" od 30T	low/reverse clutch (all)	4/5	75-94	010-323-231/C	40103C
F27	Steel .079" 6.182" id 8T	low/reverse clutch (all)	4/5	75-94	010-323-227A	40105C

ILL	DESCRIPTION		QTY	YEAR	REFERENCE #	PART #
PRESSURE PLATES						
C28	Pressure plate .115" 17 T (stepped)	direct/reverse clutch	sel	75-94	010-323-153A	40307A-R
C28	Pressure plate .260" 17T (flat)	direct/reverse clutch	sel	75-94	010-323-153A	40307B-R
C28	Pressure plate .245" 17T (flat)	direct/reverse clutch	sel	75-94	010-323-153	40307C-R
C28	Pressure plate .245" 53T (flat)	Audi 087 (direct/reverse clutch)	1	84-94	010-323-253G	40307E-R
D29	Pressure plate (beveled)	forward clutch	1	75-94	010-323-237A	40307D-R
D30	Pressure plate .245" 17T (flat)	forward clutch (reaction)	sel	75-94	010-323-153	40307C-R
FILTERS						
K9	Kit, filter (rectangular)	VW010	1	75-76	AE	FK40800C
K9	Kit, filter (round offset hole)	all	1	77-94	AE	FK40800D
H33	Filter (rectangular)	VW010	1	75-76	010-325-421	40800C
H33	Filter (round offset hole)	all	1	77-94	010-325-421A	40800D
BANDS						
C35	Band, 2nd gear brake	all	1	75-94	010-323-461C/H	40700C
BUSHINGS						
K13	Kit, bushing	all	1	75-94	AE	K40905C
C38	Bushing 1.540" id	direct/reverse clutch drum	1	75-94	010-323-115	40022
E39	Bushing, sun gear	sun gear (fron/rear)	2	75-94	010-323-017A	40023
n/i	Bushing	oil pump body	1	75-94	003-321-253	40006
n/i	Bushing	oil pump gear/torque converter hub	2	75-94	003-323-611	40004
WASHERS/BEARINGS/RACES/SHIMS						
K14	Kit, Washer	all	1	75-94	AE	K40907C
B40	Washer, thrust	front pump plastic	1	75-94	010-323-161A	40402A
B41	Bearing, thrust	pump to forward housing	1	85-94	n/a	40470
C42	Bearing, thrust	direct/reverse drum to forward housing	1	75-94	n/a	40405A
E43	Bearing, thrust	forward drum to planetary	1	75-94	n/a	40407
E44	Washer, thrust 26T	dirve shell	1	75-94	n/a	40468A
E44	Washer, thrust 28T	dirve shell	1	75-94	n/a	40468B
n/i	Washer, thrust (3-prong)	rear planet to shell/rear gear to planet	2	75-94	n/a	40471
n/i	Bearing, thrust	rear annulus gear to sun gear	1	75-94	n/a	40473
PUMP PARTS AND PUMPS						
B48	Pump assembly	washer type	1	75-94	010-321-241A	40200C-R
HARD PARTS						
n/i	Gear, governor 18T	010	1	75-94	n/a	40411C
n/i	Gear, governor 13T	010/089/090	1	76-94	n/a	40411D
n/i	Gear, governor 16T	Audi (087)	1	79-82	n/a	40411E
n/i	Gear, governor 16T	Audi w/stem (087)	1	83-94	n/a	40411F
D62	Spring, diaphragm forward drum	16 lug	1	75-94	010-323-229C	40318
D62	Spring, diaphragm forward drum	wire type	1	75-94	010-323-229D	40318A-R
SPRAGS						
F64	Sprag, overrun clutch/low	all	1	75-94	010-323-391B	40502
BONDED PISTONS						
C51	Piston, bonded rubber	direct/reverse clutch	1	75-06	010-323-121B	40527
D52	Piston, bonded rubber	forward clutch	1	75-94	010-323-217A	40530
F53	Piston, bonded rubber	1st/reverse-w/o bleed valve clutch	1	75-82	010-323-479A	40528
F53	Piston, bonded rubber	1st/reverse-w/bleed valve clutch	1	83-94	010-323-512A	40528A
n/i	Piston, bonded rubber	accumulator	1	75-94	003-325-405C	40529
NOTES						



Our Enhanced AW 55-50 Solenoids provide better performance and can save you money.

They're just the beginning of a whole new generation of solenoids that will change the industry.

Rostra Performance Class
ENHANCED LINEAR SOLENOIDS

Over 200 electronic parts covering
 more than 500 different
 vehicle applications

Rostra

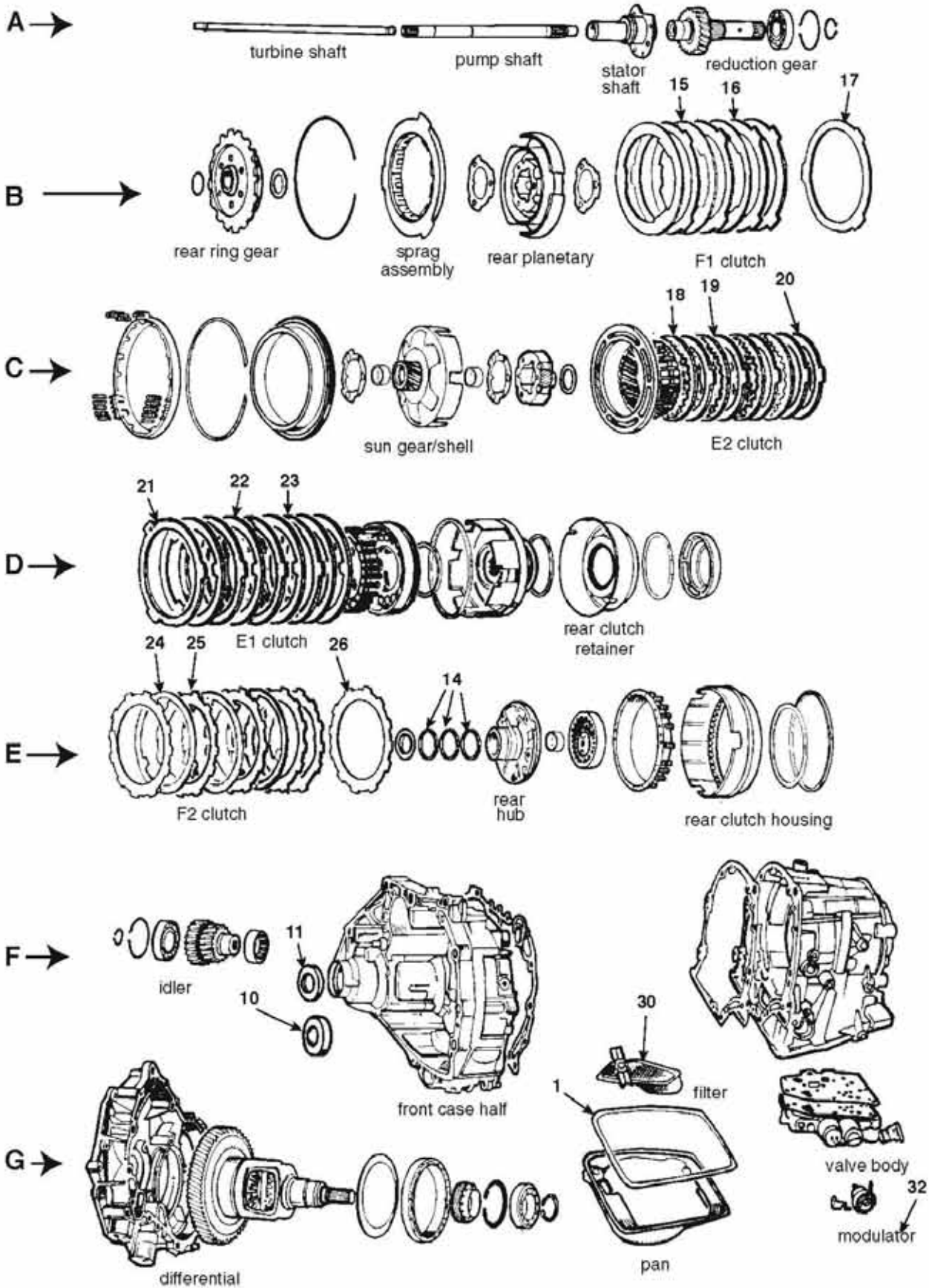

MB-1/MJ3
71000

ILL	DESCRIPTION		QTY	YEAR	REFERENCE #	PART #
REBUILDER KITS						
K5	Master kit w/steels	MB-1 (w/o E1 and E2 plates)	1	83-88	AE	K7100
K5	Master kit w/steels	MB-1 (w/E1 and E2 plates)	1	83-88	AE	K7100A
K5	Master kit w/steels	MJ-3	1	84-89	AE	K7100B
K6	Master kit w/o steels	MB-1 (w/o E1 and E2 plates)	1	83-88	AE	K7100-LS
K6	Master kit w/o steels	MB-1 (w/E1 and E2 plates)	1	83-88	AE	K7100A-LS
K6	Master kit w/o steels	MJ-3	1	84-89	AE	K7100B-LS
K7	O/H gasket set w/seals-rings	MB-1	1	83-88	AE	K71900
K7	O/H gasket set w/seals-rings	MJ3	1	84-89	AE	K71900B
K11	Gasket and seal kit	MB1/MJ3	1	83-88	AE	K71900-1
GASKETS AND RUBBER COMPONENTS						
G1	Gasket, oil pan	rubber	1	83-89	77-00-680-106	13971R
n/i	Seal, lathe cut	filter	1	83-89	77-03-065-118	13770
METAL CLAD SEALS						
F10	Seal, metal clad	MB1 (front)	1	83-89	77-03-087-135	71200
F10	Seal, metal clad 60mm od	front	1	84-89	T3065124	71200A
F11	Seal, metal clad	MB1 (axle left)	1	83-89	77-03-087-114	71201
n/i	Seal, metal clad 54mm od	axle left and right	2	84-89	T3087106	71202
SEALING RINGS						
E14	Ring, sealing (metal) 2.100"	pump cover to E1-E2 clutch	3	83-89	77-01-462-295	71300
CLUTCH PLATES						
B15	Friction .080" 7.48" od 3T	front clutch (F1)	4	83-89	7701-462-298	71103
B16	Steel .060" 6.73" id 3T	flat front clutch (F1)	5	83-89	7701-462-298	71100
B17	Steel, waved .060" 6.73" id 3T	front clutch (F1)	1	83-89	7701-462-298	71101
C18	Friction .080" 4.84" od 21T	intermediate clutch (E1)	4	83-89		71102
C19	Steel .060" 4.30" 3T	intermediate clutch (E1)	4	83-89		71104
C20	Steel, waved .060" 4.30" 3T	intermediate clutch (E1)	1	83-89		71105
D21	Friction .080" 5.25" od 3T (external T)	intermediate clutch (E2)	4	83-89	7701-596-732	71102A
D22	Steel .060" 5.85" id 3T	intermediate clutch (E2)	4	83-89		71104A
D23	Steel, waved .060" 5.85" id 3T	intermediate clutch (E2)	1	83-89		71105A
E24	Friction .080" 7.00" od 12T	rear clutch (F2)	4	83-89	7701-462-297	71106
E25	Steel .060" 7.00" od 12T	rear clutch (F2)	4	83-89	7701-462-297	71107
E26	Steel, waved .060" 7.00" od 12T	rear clutch (F2)	1	83-89	7701-462-297	71108
FILTERS						
K9	Kit, filter	MB1/MJ3	1	83-88	AE	FK71800
K9	Kit, filter	MJ3	1	86-89	AE	FK71800B
G30	Filter	DeLorean only	1	83-88	7700-712-751	71800
G30	Filter	MJ3 (w/middle pickup)	1	86-89	77007-39883	71800B
MODULATORS						
G32	Modulator, capsule	MB1	1	83-89	77-00-714-199B	71830
NOTES						

A →

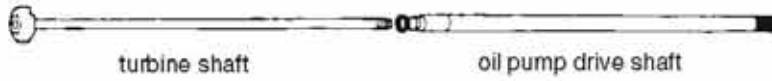

B →

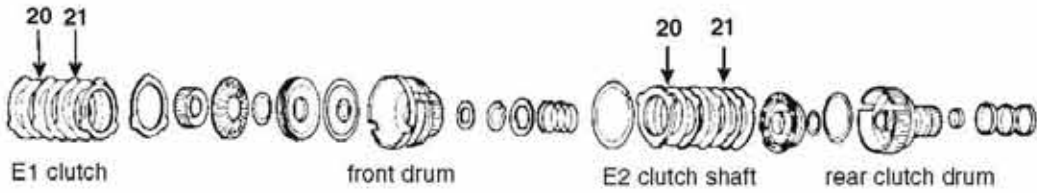

C →

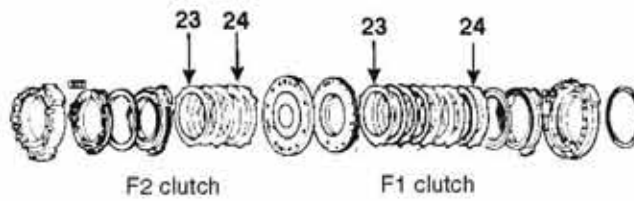

D →



E →

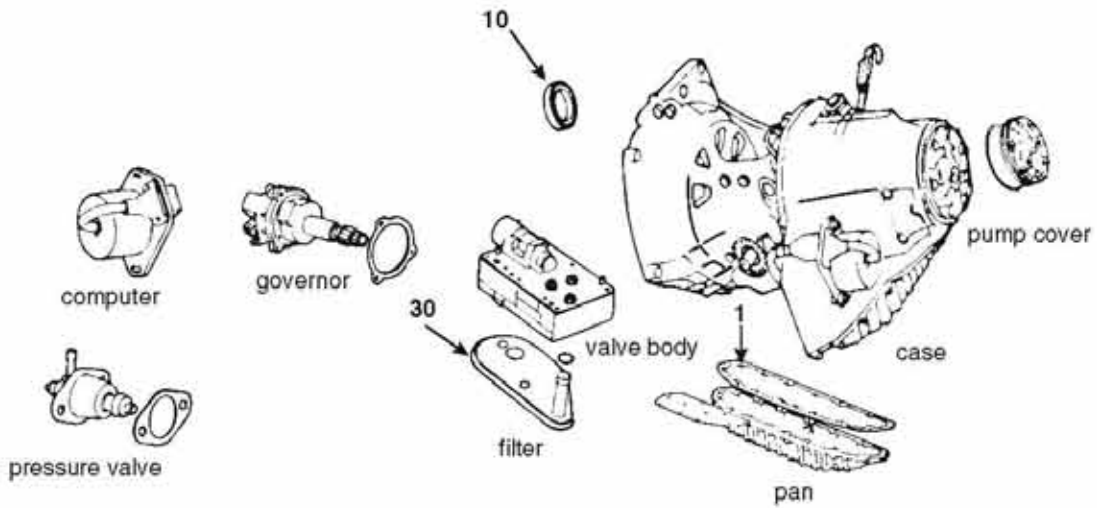

4139
71000M

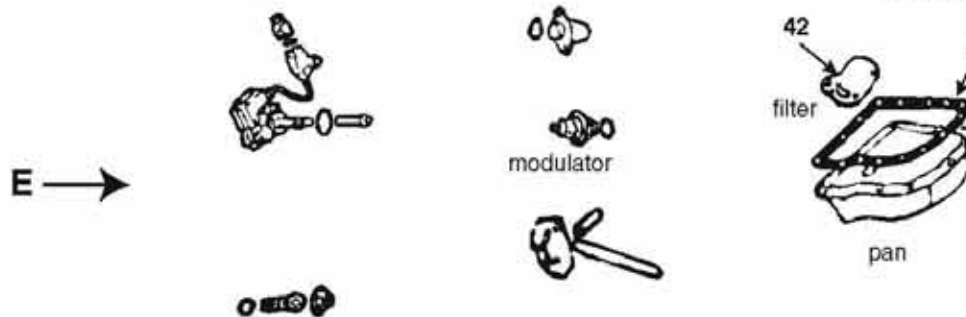
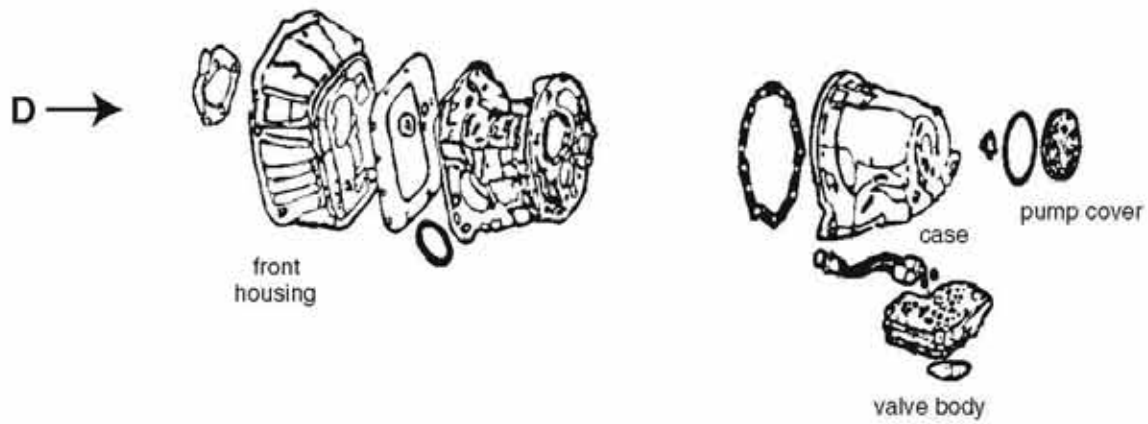
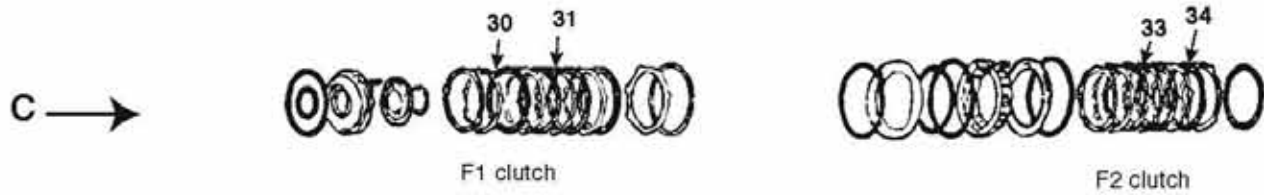
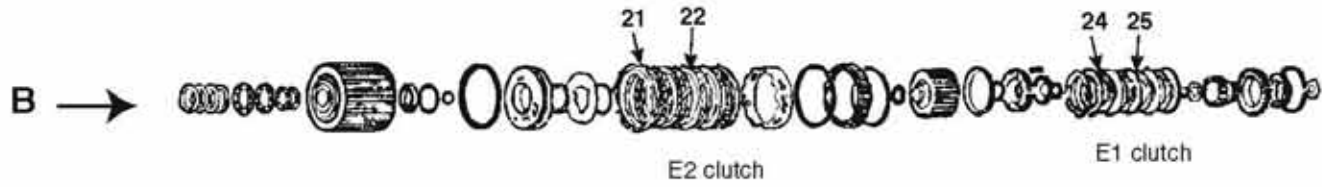

4141
71000G

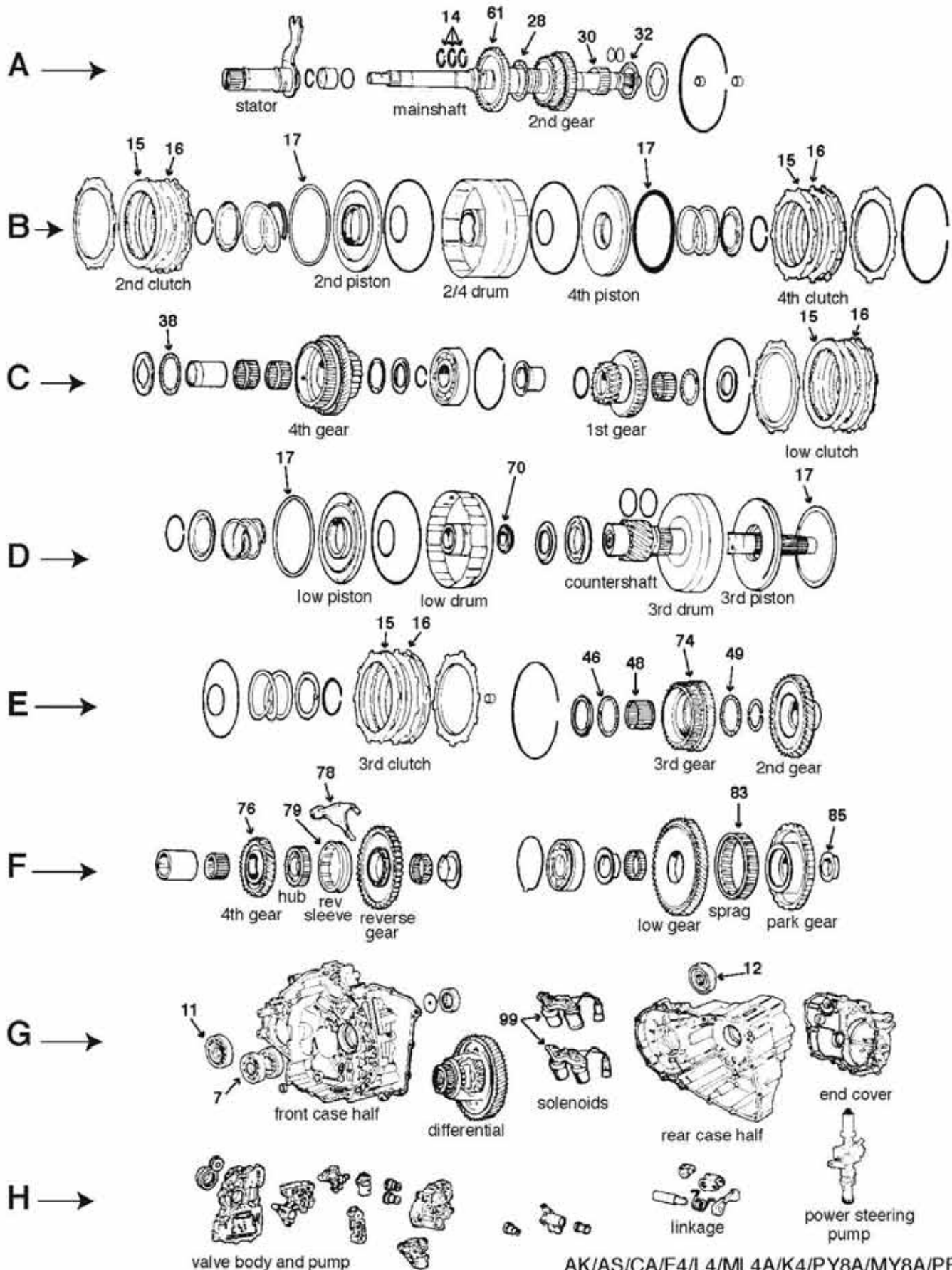

AK/AS/CA/F4/L4/ML4A/K4/PY8A/MY8A/PF4
50000D/E/G/K/L/M

ILL	DESCRIPTION		QTY	YEAR	REFERENCE #	PART #
TECHNICAL MANUALS						
K53	Tech manual 4spd carburated dis/assembly	(AK/AS) diagnosis/troubleshooting	1	83-87	HDA4spdCarbTM	010-413
K53	Tech manual 4spd F.I. dis/assembly	(F4) diagnosis/troubleshooting	1	85-89	83-HDA4spdFiTM	010-414
K53	Tech manual 4spd computer controlled	dis/assembly (diagnosis/troubleshooting)	1	88-91	83-HDA4spdCCTM	010-436
REBUILDER KITS						
K5	Master kit w/steels	Accord 106mm clutch(AK)	1	83-83	AE	K5000D
K5	Master kit w/steels	Accord (110mm clutch)	1	84-85	AE	K5000L
K5	Master kit w/steels	Prelude w/carb 110mm clutch (AS)	1	83-87	AE	K5000L
K5	Master kit w/steels	Accord (116mm clutch)	1	85-89	AE	K5000M
K5	Master kit w/steels	Prelude w/ F.I. 116mm clutch (F4/PF4)	1	85-87	AE	K5000M
K5	Master kit w/steels	Civic/CRX 110mm clutch (CA)	1	86-87	AE	K5000E
K5	Master kit w/steels	Civic/CRX 2WD 110mm clutch (L4/ML4A)	1	88-91	AE	K5000G
K5	Master kit w/steels	Prelude 116mm clutch (K4/PY8A/MY8A)	1	88-91	AE	K5000K
K6	Master kit w/o steels	Accord 106mm clutch (AK)	1	83-83	AE	K5000D-LS
K6	Master kit w/o steels	Accord (110mm clutch)	1	84-85	AE	K5000L-LS
K6	Master kit w/o steels	Prelude w/carb 110mm clutch (AS)	1	83-87	AE	K5000L-LS
K6	Master kit w/o steels	Accord (116mm clutch)	1	86-89	AE	K5000M-LS
K6	Master kit w/o steels	Prelude w/F.I. 116mm clutc (F4/PF4h)	1	85-87	AE	K5000M-LS
K6	Master kit w/o steels	Civic/CRX 2WD 110mm clutch (AS)	1	86-91	AE	K5000L-LS
K6	Master kit w/o steels	Prelude w/116mm clutch (K4/PY8A/MY8A)	1	88-91	AE	K5000K-LS
K7	O/H gasket set w/seals-rings	Accord	1	82-85	AE	K50900L
K7	O/H gasket set w/seals-rings	Prelude w/carb (AK/AS)	1	83-89	AE	K50900L
K7	O/H gasket set w/seals-rings	Accord	1	86-89	AE	K50900M
K7	O/H gasket set w/seals-rings	Prelude w/F.I. (F4/(PF4)	1	85-87	AE	K50900M
K7	O/H gasket set w/seals-rings	Civic/CRX (CA/L4/ML4A)	1	86-91	AE	K50900L
K7	O/H gasket set w/seals-rings	Prelude (K4/PY8A/MY8A)	1	88-91	AE	K50900K
GASKETS AND RUBBER COMPONENTS						
n/i	O'ring, converter hub 31.98mm	1.9mm thick	1	83-07	B17535	23042
n/i	O'ring, converter hub 35.5mm	1.9mm thick	1	86-07	B17928	23043
METAL CLAD SEALS						
G7	Seal, metal clad 35x68x5mm	Honda 4-speed front seal	1	83-91	91207-639-015	50201
G11	Seal, metal clad 40x76x9mm	Accord (left axle)	1	86-89	91206-PC9-711	50209
G11	Seal, metal clad 40x76x9mm	Accord w/F.I. (left axle)	1	85-85	91206-PC9-711	50209
G11	Seal, metal clad 40x76x9mm	Prelude w/F.I. (left axle)	1	85-87	91206-PC9-711	50209
G11	Seal, metal clad 35x76x9mm	Accord w/carb (left axle)	1	83-85	91206-PC9-005	50205
G11	Seal, metal clad 35x76x9mm	Prelude w/carb (left axle)	1	83-87	91206-PC9-005	50205
G11	Seal, metal clad 35x76x9mm	Civic/CRX (left axle)	1	86-87	91206-PC9-005	50205
G11	Seal, metal clad 35x56x8mm	Civic/CRX (2WD left axle)	1	88-91	91205-PX5-005	50211
G11	Seal, metal clad 35x56x8mm	Prelude (left axle)	1	90-91	91205-PX5-005	50211
G11	Seal, metal clad 38x54x8mm	Prelude (left axle)	1	88-89	91205-PC8-935	50214
G11	Seal, metal clad 38x54x8mm	Civic/CRX 4WD (left axle)	1	88-91	91205-PC8-935	50214
G12	Seal, metal clad 35x62x9mm	Accord w/carb (right axle)	1	83-85	91205-PC9-005	50206
G12	Seal, metal clad 35x62x9mm	Prelude w/carb (right axle)	1	83-87	91205-PC9-005	50206
G12	Seal, metal clad 35x62x9mm	Civic/CRX (right axle)	1	86-87	91205-PC9-005	50206
G12	Seal, metal clad 40x62x9mm	(Accord (right axle)	1	85-89	91205-PC9-711	50208
G12	Seal, metal clad 40x62x9mm	Accord w/F.I. (right axle)	1	85-85	91205-PC9-711	50208
G12	Seal, metal clad 40x62x9mm	Prelude w/F.I. (right axle)	1	85-87	91205-PC9-711	50208
G12	Seal, metal clad 40x66x8mm	(Prelude) right axle	1	88-91	91206-PK4-003	50215
G12	Seal, metal clad 35x76x9mm	Civic/CRX 2WD (right axle)	1	88-91	91206-689-005	50205
G12	Seal, metal clad 40x76x9mm	Civic/CRX 4WD (right axle)	1	88-91	91206-PC8-005	50209
n/i	Seal, metal clad 12x22x7mm	all (shift shaft0	1	83-91	91209-612-003	46202
n/i	Seal, metal clad 9x18x7mm	all (throttle shaft)	1	83-91	91201-PA9-003	50204
n/i	Seal, metal clad 38x60x11mm	Civic/CRX 4wd (rear adapter housing)	1	89-91	91201-PH8-005	50229

AK•AS•CA•F4•L4•ML4A•K4•PY8A•MY8A•PF4

AK•AS•CA•F4•L4•ML4A•K4•PY8A•MY8A•PF4

ILL	DESCRIPTION	QTY	YEAR	REFERENCE #	PART #
SEALING RINGS					
K10	Kit, sealing ring Accord	1	83-85	AE	K50300C
K10	Kit, sealing ring Prelude (w/carb)	1	83-87	AE	K50300C
K10	Kit, sealing ring Civic/CRX	1	86-91	AE	K50300C
K10	Kit, sealing ring-metal Prelude (w/F.I.)	1	86-87	AE	K50300E
K10	Kit, sealing ring-metal Accord	1	86-89	AE	K50300E
A14	Ring, sealing large-metal 32mm mainshaft for 106/110mm clutch 32mm	2/3	83-91	22814-PA9-023	50300C
A14	Ring, sealing-large-metal 35mm mainshaft for 116mm clutch 35mm	3/4	83-91	22814-PF4-003	50300D
A14	Ring, sealing-small-metal 29mm Prelude (mainshaft small 29mm)	1	88-91	22814-PK4-003	50300E
CLUTCH PLATES					
B15	Friction .075" 4.171" od 38T (106mm) AK (2nd clutch)	3	83-83	22544-PA9-010	50103C
B15	Friction .075" 4.323" od 38T (110mm) AS/CA/L4/ML4A (2nd clutch)	3	84-91	22544-P24-A01	50103D
B15	Friction .075" 4.570" od 41T (116mm) F4/K4/PY8A/MY8A (2nd clutch)	3	85-91	22544-PF4-010	50103E
B16	Steel .079" 3.220" id 8T (80mm) AK (2nd clutch)	3	83-83	22543-PA9-000	50100C
B16	Steel .079" 3.230" id 8T (80mm) AS/L4/ML4A (2nd clutch)	3	84-91	22543-PC9-000	50100D
B16	Steel .079" 3.438" id 10T F4/K4/PY8A/MY8A (2nd clutch)	3	85-91	22543-PF4-000	50100E
B15	Friction .075" 4.171" od 38T (106mm) AK (4th clutch)	3	83-83	22544-PA9-010	50103C
B15	Friction .075" 4.323" od 38T (110mm) AS/CA/L4/ML4A (4th clutch)	3	84-91	22544-P24-A01	50103D
B15	Friction .075" 4.570" od 41T (116mm) F4/K4/PY8A/MY8A (4th clutch)	3	85-91	22544-PF4-010	50103E
B16	Steel .079" 3.220" id 8T (80mm) AK (4th clutch)	3	83-83	22543-PA9-000	50100C
B16	Steel .079" 3.230" id 8T (80mm) AS/CA/L4/ML4A (4th clutch)	3	84-91	22544-P24-A01	50100D
B16	Steel .079" 3.438" id 10T F4/K4/PY8A/MY8A (4th clutch)	3	85-91	22543-PF4-000	50100E
C15	Friction .075" 4.171" od 38T (106mm) AK (low clutch)	3	83-83	22544-PA9-010	50103C
C15	Friction .075" 4.323" od 38T (110mm) AS/CA/L4/ML4A (low clutch)	3	84-91	22544-P24-A01	50103D
C15	Friction .075" 4.570" od 41T (116mm) F4/K4/PY8A/MY8A (low clutch)	3	85-91	22544-PF4-010	50103E
C16	Steel .079" 3.220" id 8T (80mm) AK (low clutch)	3	83-83	22543-PA9-000	50100C
C16	Steel .079" 3.230" id 8T (80mm) AS/CA/L4/ML4A (low clutch)	3	84-91	22544-P24-A01	50100D
C16	Steel .079" 3.438" id 10T F4/K4/PY8A/MY8A (low clutch)	3	85-91	22543-PF4-000	50100E
E15	Friction .075" 4.171" od 38T (106mm) AK (3rd clutch)	3	83-83	22544-PA9-010	50103C
E15	Friction .075" 4.323" od 38T (110mm) AS/CA/L4/ML4A (3rd clutch)	3	84-91	22544-P24-A01	50103D
E15	Friction .075" 4.570" od 41T (116mm) F4/K4/PY8A/MY8A (3rd clutch)	3	85-91	22544-PF4-010	50103E
E16	Steel .079" 3.220" id 8T (80mm) AK (3rd clutch)	3	83-83	22543-PA9-000	50100C
E16	Steel .079" 3.230" id 8T (80mm) AS/CA/L4/ML4A (3rd clutch)	3	84-91	22544-P24-A01	50100D
E16	Steel .079" 3.438" id 10T F4/K4/PY8A/MY8A (3rd clutch)	3	85-91	22543-PF4-000	50100E
n/i	Steel .083" 3.220" id 8T (os) (80mm) AK (1st/2nd/3rd/4th clutch)	sel	83-83	058701-210	50100CX
n/i	Steel .070" 3.220" id 8T (us) (80mm) AK (1st/2nd/3rd/4th clutch)	sel	83-83	058701A	50104
n/i	Steel .063" 3.230" id 8T (us) (87mm) CA/L4/ML4A (1st/2nd/3rd/4th clutch)	sel	86-91	058713	50100F
n/i	Steel .079" 3.152" id 8T (os) (80mm) AS/L4/ML4A (1st/2nd/3rd/4th clutch)	sel	84-91	058711-210	50100DX
n/i	Steel .066" 3.152" id 8T (us) (80mm) AS/L4/ML4A (1st/2nd/3rd/4th clutch)	sel	84-91	058711A	50106
n/i	Steel .083" 3.152" id 10T (os) F4/K4/PY8A/MY8A (1st/2nd/3rd/4th clutch)	sel	85-91	058721-210	50100EX
n/i	Steel .070" 3.152" id 10T (us) (87mm) F4/K4/PY8A/MY8A (1st/2nd/3rd/4th clutch)	sel	85-91	058721A	50108
n/i	Wave spring 1st/2nd/3rd/4th replaces belleville spring w/110mm	1	84-91	058767-110	50150
n/i	Wave spring 1st/2nd/3rd/4th/1st hold replaces belleville spring w/116mm	1	85-91	058711-116	50151
FILTERS					
n/i	Filter, oil screen AK/AS/CA/F4 (disassembly required)	1	83-89	25420-PC9-010	50800D
n/i	Filter, oil screen Civic 2WD L4/ML4A (disassembly required)	1	88-91	25420-PL4-000	50800F
n/i	Filter, oil screen Prelude K4 (disassembly required)	1	88-89	25420-PK4-000	50800J
n/i	Filter, oil sreen Prelude PY8A/MY8A (disassembly required)	1	90-91	25420-PY8-510	50800K
BUSHINGS					
K13	Kit, bushing AS-S5 (pinion/mainshaft)	1	83-91	AE	K50901
WASHERS/BEARINGS/RACES/SHIMS					
A28	Bearing, thrust 58x42x2mm AK/AS/F4/CA (2nd gear to mainshaft)	1	83-87	91026-PS5-003	50501B
A28	Bearing, thrust 52x36x2mm L4/ML4A/S5 (2nd gear to mainshaft)	1	87-90	91023-PS5-003	50501
A28	Bearing, thrust 56x36x2.5mm F4-MY8A (2nd gear to mainshaft)	1	89-91	91023-PG4-013	50501A

ILL	DESCRIPTION		QTY	YEAR	REFERENCE #	PART #
WASHERS/BEARINGS/RACES/SHIMS (CONTINUED)						
A30	Bearing, caged 41x36x18mm	AK-MY8A (2nd gear mainshaft)	1	83-91	91027-PC9-E01	50502A
A32	Bearing, thrust 52x36x2mm	AK/AS/CA/F (2nd gear to drum)	1	83-87	91023-PS5-003	50501
A32	Bearing, thrust 54x39x2mm	F4-MY8A (2nd gear to drum)	1	88-91	91031-PC9-003	50501E
C38	Bearing, thrust 54x39x2mm	AK-KA (4th gear to drum)	1	83-91	91031-PC9-003	50501E
E46	Bearing, thrust 52x35x2mm	AK/AS/F4/CA/S5 (2rd gear to drum)	1	83-91	91014-PA9-003	50501D
E46	Bearing, thrust 54x39x2mm	L4/ML4A (3rd gear to drum)	1	88-91	91031-PC9-003	50501E
E48	Bearing, caged 38x32x24mm	F4/K4/PY8A/MY8A (3rd gear counter)	1	83-91	91028-PF4-A01	50502
E49	Bearing, thrust 54x39x2mm	AK-S5 (3rd gear to 2nd gear counter)	1	83-90	91031-PC9-003	50501E
HARD PARTS						
A63	Gear, mainshaft, 2nd	AK/AS (25T no id grooves)	1	83-87	23431-PC9-010	50418B
A63	Gear, mainshaft 2nd (change over kit)	F4 (27T 1 id groove)	1	86-87	23431-PF4-305	50418
A63	Gear, mainshaft 2nd	CA/L4/ML4A (25T 3 id grooves)	1	86-91	23431-PHO-670	50418A
A63	Gear, mainshaft 2nd	K4 (27T 2 id grooves)	1	88-89	23431-PF4-932	50418C
A63	Gear, mainshaft 2nd	F4/K4 (27T 1 id groove .625" thick)	1	88-89	23431-PF4-020	50418D
D70	Nut, mainshaft left hand thread 19mm	AK/AS/F4/CA/K4/ML4A/S5	1	83-91	90201-PA9-000	50330
E74	Gear, countershaft 3rd	CA	1	86-87	23451-PHO-000	50446
F76	Gear, countershaft 4th	F4 (28T 1 id groove 2.950" diameter)	1	86-88	23471-PF4-640	50426
F76	Gear, countershaft 4th 29T 3 id grooves	K4/F4 (Prelude F.I. 86-89)	1	86-89	23471-PF4-950	50426A
F78	Shift Fork	F4 (casting #F4 w/2.200" selector)	1	85-87	24111-PF4-010	50723
F78	Shift Fork	F4 (casting #F4 w/2.275" selector)	1	87-89	24111-PF4-020	50723A
F79	Selector, reverse	Prelude AK/F4/AS (2.200" diameter)	1	83-87	23565-PC9-000	50436
F79	Selector, reverse (shift sleeve)	AS/CA/L4 (2.200" diameter)	1	84-88	23565-PC9-830	50436A
F79	Selector, reverse	F4/K4/PY8A/MY8A (2.275" diameter)	1	88-91	23565-PF4-000	50436B
F85	Nut, countershaft 20mm	AK/AS/CA	1	83-87	90201-689-900	50334
F85	Nut, right hand thread 19mm	F4	1	85-87	90201-PL4-000	50332
n/i	Nut, secondary shaft, 20mm	S5	1	88-91	91201-PS5-000	50339
n/i	Hub, repair (req. machining and welding)	1.700" hub diameter	1	86-91	AE	50911
n/i	Hub, repair (req. machining and welding)	1.660" hub diameter	1	86-91	AE	50912
ELECTRICAL COMPONENTS						
G99	Solenoid assembly, shift	K4	1	88-89	28203-PK4-305	5A-743
G99	Solenoid assembly, shift	PY8A	1	90-91		5A-744
n/i	Solenoid, lock-up	K4	1	88-89	28300-PK4-013	5A-710
n/i	Solenoid, lock-up	K4	1	88-89	28300-PK4-901	5A-710A
n/i	Solenoid, lock-up	PY8A	1	90-91	28300-PY8-J10	5A-711
n/i	Solenoid, shift	L4	1	88-91	28200-PL4-681	5A-712
SPRAGS						
F83	Sprag, assembly one way	(AK/AS/L4/CA/ML4A)	1	83-91	23423-PA9-003	50503
F83	Sprag, assembly one way clutch	(F4,K4,PY8A,MY8A,S5)	1	85-91	23423-PF4-003	50506
NOTES						

Sterling 4-Speed

Sterling 4-Speed

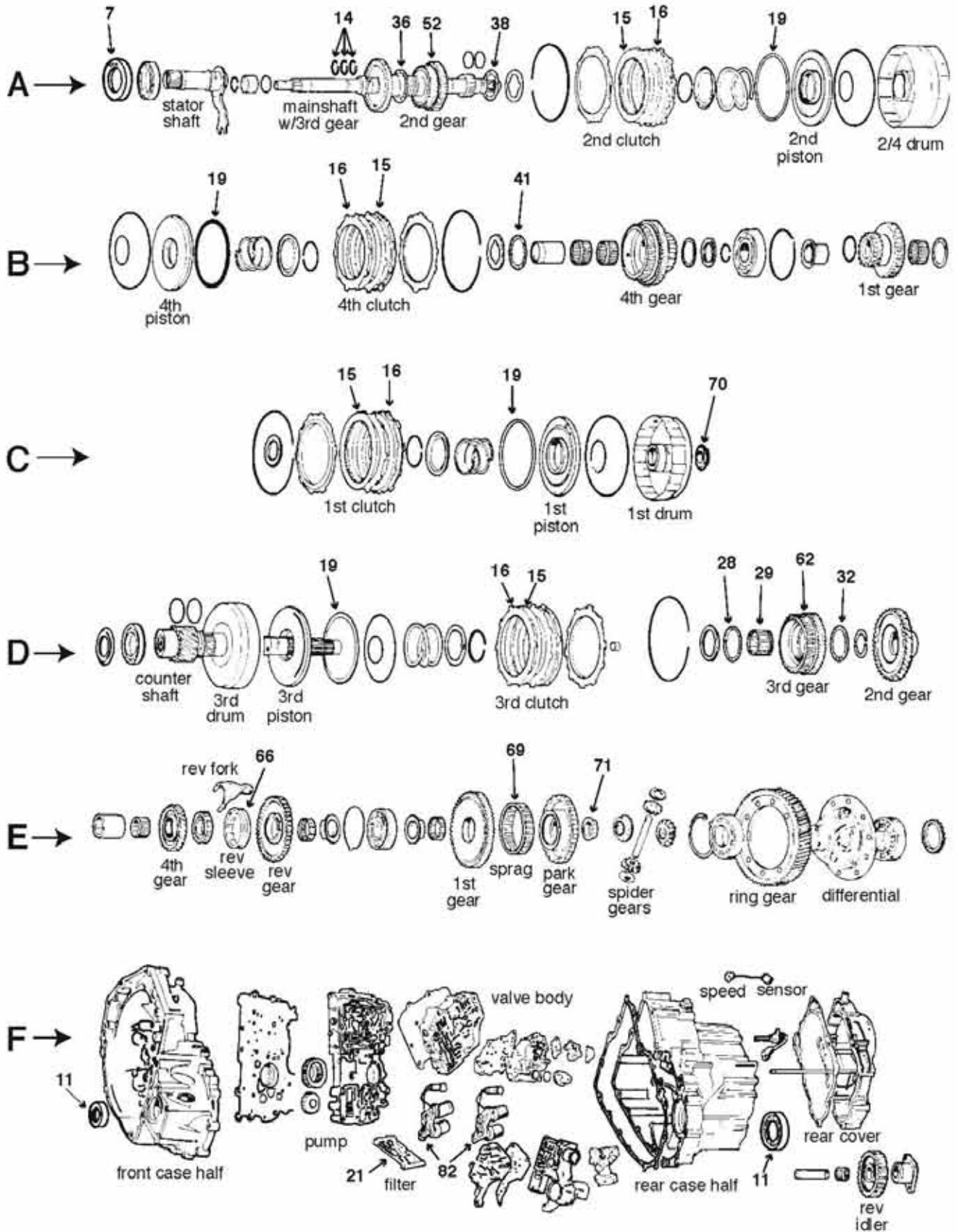

Sterling 4-speed
50000F

ILL	DESCRIPTION		QTY	YEAR	REFERENCE #	PART #
TECHNICAL MANUALS						
K53	Tech manual Sterling (G4/L5) dis/assembly	diagnosis/troubleshooting	1	87-91	83-LEG8788 TM	010-439
REBUILDER KITS						
K5	Master kit w/steels	Sterling 4-speed (G4/L5)	1	87-91	AE	K5000F
K6	Master kit w/o steels	Sterling 4-speed (G4/L5)	1	87-91	AE	K5000F-LS
K7	O/H gasket set w/seals-rings	Sterling 4-speed (G4/L5)	1	87-91	AE	K50900F
METAL CLAD SEALS						
A7	Seal, metal clad 44x68x8mm	converter (front seal)	1	87-91	XHM5108	50201A
F11	Seal, metal clad 40x56x9mm	left/right axle	2	87-91	XHM5008	50210
n/i	Seal, metal clad 9x18x7mm	throttle valve shaft (TV shaft)	1	87-91	91201-PA9-003	50204
n/i	Seal, metal clad 12x22x7mm	manual lever (lever seal)	1	87-91	91209-612-003	46202
SEALING RINGS						
K10	Kit, sealing ring	Sterling 4-speed	1	87-91	AE	K50300C
A14	Ring, sealing-large-metal 35mm	Sterling 4-speed mainshaft	3	87-91	XHM5159	50300D
CLUTCH PLATES						
A15	Friction .075" 4.570" od 41T (116mm)	2nd clutch	4	87-91	22544-PF4-010	50103E
A16	Steel .079" 3.438" id 10T	2nd clutch	4	87-91	22543-PF4-00	50100E
B15	Friction .075" 4.570" od 41T (116mm)	4th clutch	4	87-91	22544-PF4-010	50103E
B16	Steel .079" 3.438" id 10T	4th clutch	4	87-91	22543-PF4-00	50100E
C15	Friction .075" 4.570" od 41T (116mm)	1st clutch	4	87-91	22544-PF4-010	50103E
C16	Steel .079" 3.438" id 10T	1st clutch	4	87-91	22543-PF4-00	50100E
D15	Friction .075" 4.570" od 41T (116mm)	3rd clutch	4	87-91	22544-PF4-010	50103E
D16	Steel .079" 3.438" id 10T	3rd clutch	4	87-91	22543-PF4-00	50100E
n/i	Steel .083" 3.152" id 10T (os)	1st/2nd/3rd/4th clutch	1	87-91	058721-210	50100EX
n/i	Steel .070" 3.152" id 10T (us) (87mm)	1st/2nd/3rd/4th clutch	1	87-91	058721A	50108
n/i	Wave spring 1st/2nd/3rd/4th/1st hold	replaces belleville spring w/116mm	1/4	87-91	058767-116	50151
FILTERS						
F21	Filter, oil screen (disassembly required)	G4/L5	1	87-91	ECP550	50800E
BUSHINGS						
K13	Kit, bushing	Sterling 4-speed	1	87-91	AE	K50901
WASHERS/BEARINGS/RACES/SHIMS						
A36	Bearing, thrust 58x42x2mm	G4/L5 2nd gear to mainshaft	1	87-91	443-443600-40	50501B
A38	Bearing, thrust 56x36x2.5mm	G4/L5 2nd gear to washer	1	87-91	ECP687	50501A
HARD PARTS						
C70	Nut, right hand thread 23mm	L5 (mainshaft)	1	89-91	91201-PG4-000	50331
C70	Nut, right hand thread 23mm	G4 (mainshaft)	1	87-89	91205-PL5-200	50333
E71	Nut 23mm	G4/L5 (countershaft)	1	87-91	90202-PL5-000	50335
E71	Nut 24mm	L5 (countershaft)	1	89-91	90202-PL5-201	50336
ELECTRICAL COMPONENTS						
F82	Solenoid, shift	G4/L5	1	87-91	EDU4211	5A-713
F82	Solenoid, lock-up	G4/L5	1	87-91	EDU4213	5A-714
SPRAGS						
E69	Sprag, assembly	G4 oneway clutch	1	89-91	XHM5195	50516
E69	Sprag, assembly	L5 oneway clutch	1	87-88	443-443601-36	50517
NOTES						

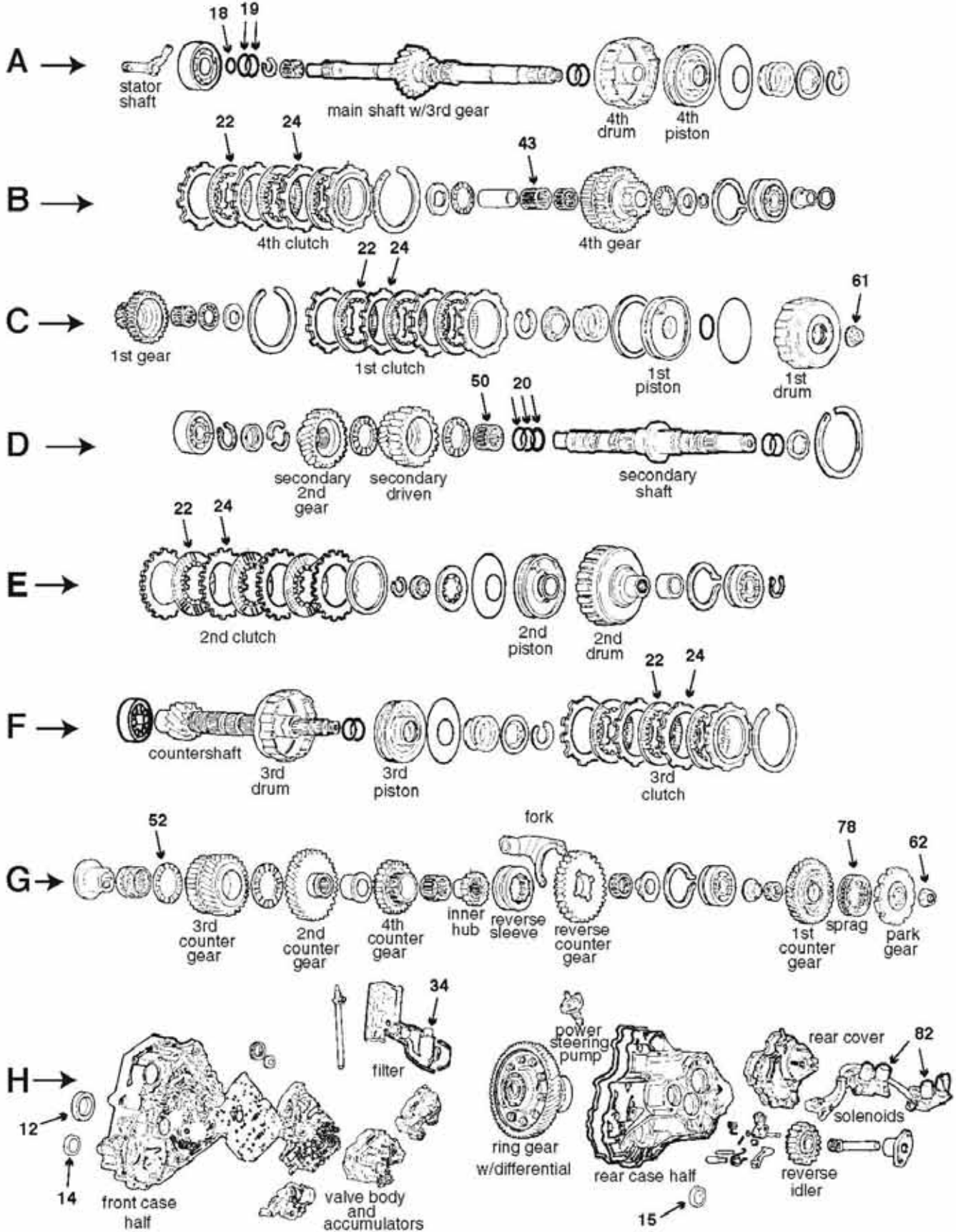

RO/MPRA/MP7A/SP7A/S4XA/SKWA
50000A/P

ILL	DESCRIPTION		QTY	YEAR	REFERENCE #	PART #
TECHNICAL MANUALS						
K53	Tech manual ACURA RO/MPRA dis/assembly	diagnosis/troubleshooting	1	90-93	83-RO/MPRATM	010-467
REBUILDER KITS						
K5	Master kit w/steels	RO/MPRA	1	90-93	AE	K5000P
K5	Master kit w/steels	MP7A/SP7A/S4XA/SKWA	1	94-00	AE	K5000A
K6	Master kit w/o steels	RO/MPRA	1	90-93	AE	K5000P-LS
K6	Master kit w/o steels	MP7A/SP7A/S4XA/SKWA	1	94-00	AE	K5000A-LS
K7	O/H gasket set w/seals-rings	RO/MPRA	1	90-93	AE	K50900P
K7	O/H gasket set w/seals-rings	MP7A/SP7A/S4XA/SKWA	1	94-00	AE	K50900A
GASKETS AND RUBBER COMPONENTS						
n/i	Seal, oil filter	all	1	94-00	21113-P56-003	13929
METAL CLAD SEALS						
H12	Seal, metal clad 35x68x5mm	front seal	1	90-00	91207-P56-003	50201
H14	Seal, metal clad 40x56x9mm	RO/MPRA (bell housing)	1	90-93	91205-PL3-B01	50210
H14	Seal, metal clad 35x56x8mm	MP7A/SP7A/S4XA/SKWA (bell housing)	1	94-00	91205-PL3-A01	50211
H15	Seal, metal clad 40x76x9mm	RO/MPRA/MP7A/SP7A/S4XA (case)	1	90-00	91206-PC8-005	50209
n/i	Seal, metal clad 12x22x7mm	lever seal	1	90-00	91209-612-003	46202
n/i	Seal, metal clad 9x18x7mm	throttle shaft	1	90-00	91201-PA9-003	50204
SEALING RINGS						
K10	Kit, sealing ring-metal	RO/MPRA	1	90-93	AE	K50300F
K10	Kit, sealing ring-metal	MP7A/SP7A	1	94-95	AE	K50300E
K10	Kit, sealing ring-teflon	S4XA/SKWA	1	96-00	AE	K50300H
A18	Ring, sealing-small-metal 29mm	RO/MPRA/MP7A/SP7A (mainshaft)	1	90-95	22814-PK4-003	50300E
A18	Ring, sealing-small-teflon 29mm	S4XA/SKWA (mainshaft)	1	96-00	22815-P4P-003	50306
A19	Ring, sealing-large-metal 35mm	RO/MPRA/MP7A/SP7A (mainshaft)	3	90-95	22814-PF4-003	50300D
A19	Ring, sealing-large-teflon 35mm	S4XA/SKWA (mainshaft)	3	96-00	22814-P4P-003	50307
D20	Ring, sealing-metal 27mm	RO/MPRA (secondary shaft)	3	90-93	22814-PR0-003	50308
CLUTCH PLATES						
B22	Friction .075" 4.570" od 41T (116mm)	RO/MPRA (4th clutch)	3	90-93	22544-PR0-003	50103E
B22	Friction .075" 116mm od 38T	MP7A/SP7A/S4XA/SKWA (4th clutch)	3	94-00	22544-P56-N01	50120
B24	Steel .079" 3.438" id 10T	RO/MPRA (4th clutch)	3	90-93	22543-PF4-000	50100E
B24	Steel .079" 82mm id 10T	MP7A/SP7A/S4XA/SKWA (4th clutch)	3	94-00	22543-P56-N00	50115
C22	Friction .075" 4.570" od 41T (116mm)	RO/MPRA/MP7A/SP7A (1st clutch)	3	90-99	22544-PR0-003	50103E
C22	Friction .075" 116mm od 38T	(S4ZA/SKWA) (1st clutch)	3	96-00	22644-P4X-003	50121
C24	Steel .079" 3.438" id 10T	RO/MPRA (1st clutch)	3	90-93	22543-PF4-000	50100E
C24	Steel .063" 82mm id 10T	MP7A/SP7A/S4XA/SKWA (1st clutch)	3	96-00	22543-P4X-000	50115A
C24	Steel .079" 3.438" id 10T	MP7A/SP7A (1st clutch)	3	94-95	22543-PF4-000	50100E
E22	Friction .075" 4.570" od 41T (116mm)	RO/MPRA (2nd clutch)	3	90-93	22544-PR0-003	50103E
E22	Friction .075" 116mm od 38T	MP7A/SP7A/S4XA/SKWA (2nd clutch)	3	94-00	22544-P56-N01	50120
E24	Steel .118" 87mm id 24T	RO (2nd clutch)	3	90-90	22644-PR0-003	50113B
E24	Steel .079" 87mm id 24T	MPRA (2nd clutch)	3	91-93	22643-PR0-003	50113
E24	Steel .079" 82mm id 10T	MP7A/SP7A/S4XA/SKWA (2nd clutch)	3	96-00	22543-P56-N00	50115
F22	Friction .075" 4.570" od 41T (116mm)	RO/MPRA (3rd clutch)	3	94-95	22544-PR0-850	50103E
F22	Friction .075" 116mm od 38T	MP7A/SP7A/S4XA/SKWA (3rd clutch)	3	94-00	22544-P56-N01	50120
F24	Steel .079" 3.438" id 10T	RO/MPRA (3rd clutch)	3	91-93	22543-PF4-000	50100E
F24	Steel .079" 82mm id 10T	MP7A/SP7A/S4XA/SKWA (3rd clutch)	3	96-00	22543-P56-N00	50115
n/i	Friction .079" 3.940" od 38T	MP7A/SP7A/S4XA/SKWA (secondary shaft)	3	94-00	22544-PS5-003	50109
n/i	Steel .079" 2.797" id 18T	MP7A/SP7A (secondary shaft)	3	94-95	22543-PS5-003	50116
n/i	Steel .063" 71mm id 18T	S4XA/SKWA (secondary shaft)	3	96-00	22543-PS5-013	50117
n/i	Steel .083" 3.152" id 10T (os)	1st/3rd/4th clutch	sel	90-93	058721-210	50100EX
n/i	Steel .070" 3.152" id 10T (us) (87mm)	1st/3rd/4th clutch	sel	90-93	058721A	50108
n/i	Wave spring 1st/2nd/3rd/4th/1st hold	replaces Belleville spring w/116mm	1	90-00	058767-116	50151

MAKE	MODEL	YEAR
GM	6L80E	2006-On

DESCRIPTION & NOTES...

Now Available!

6L80E

PowerPacks®

OEI® Original Equipment Improvements

Alto #	Description
195756	4-5-6 Clutch Hi-Performance PowerPack®
195757	3-5 Reverse Clutch Hi-Performance PowerPack®

- Extended Durability
- Superior Coefficient of Friction
- Elevated Heat Management



Call your A & REDS Representative for price and availability.

SHIFT ...YOUR THINKING

Clutches and Gears for Automatic Transmissions

10007023



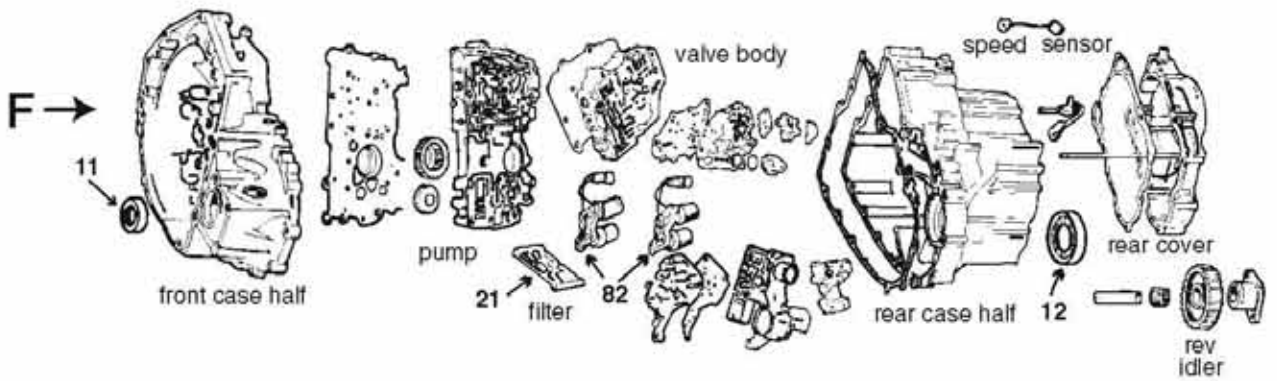
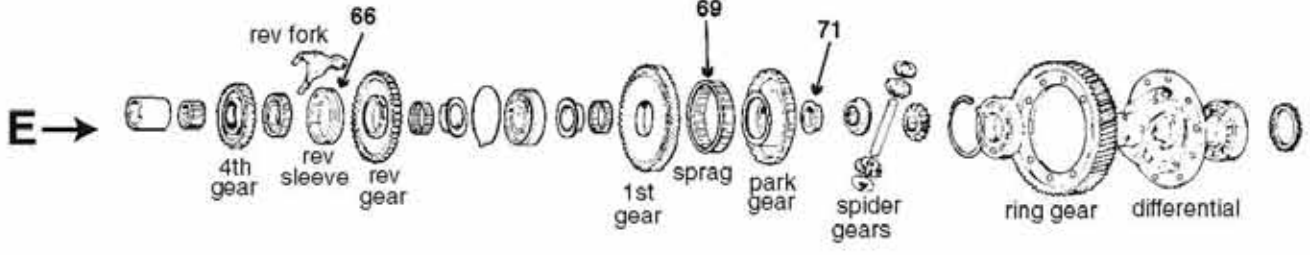
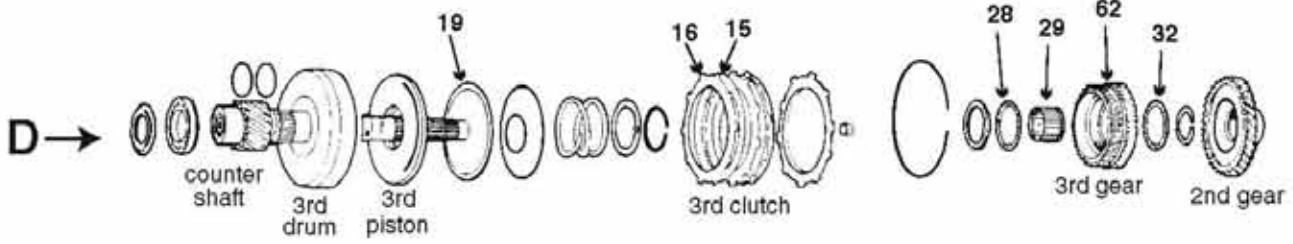
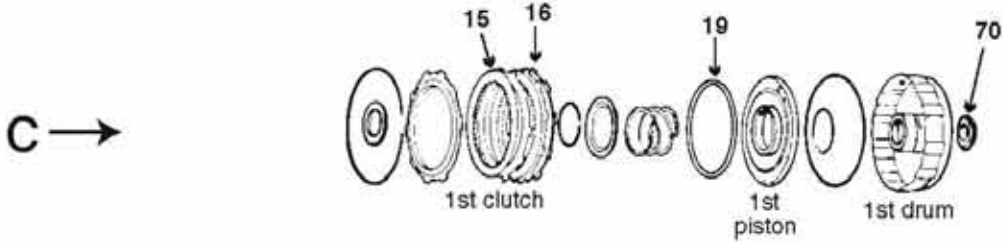
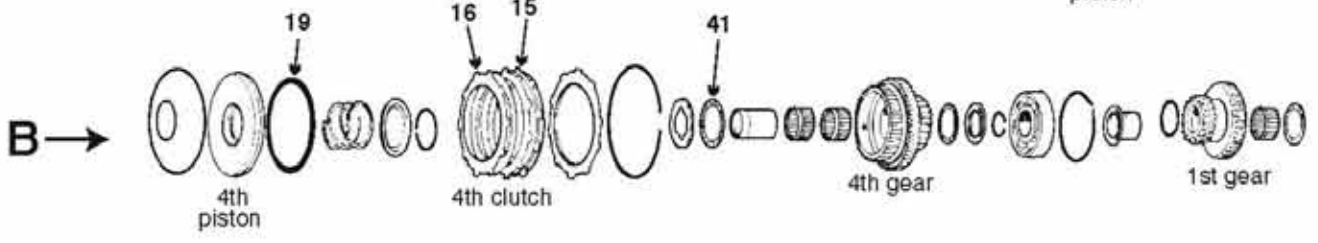
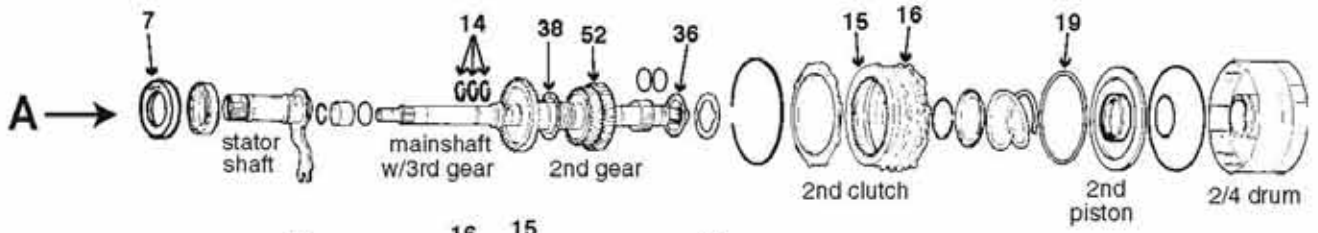

CA/P1/G4/L5/PL5X
50000F/S

ILL	DESCRIPTION		QTY	YEAR	REFERENCE #	PART #
TECHNICAL MANUALS						
K53	Tech manual Integra (CA/P1) dis/assembly	diagnosis/troubleshooting	1	86-89	83-INT8788TM	010-438
K53	Tech manual Sterling (G4/L5) dis/assembly	diagnosis/troubleshooting	1	86-87	83-LEG8788TM	010-439
K53	Tech manual Legend (L5/PL5X) dis/assembly	diagnosis/troubleshooting	1	88-90	83-LEG8990TM	010-440
REBUILDER KITS						
K5	Master kit w/steels	Integra CA/P1 (110mm)	1	86-89	AE	K5000S
K5	Master kit w/steels	G4/L5/PL5X (116mm)	1	86-90	AE	K5000F
K6	Master kit w/o steels	Integra CA/P1 (110mm)	1	86-89	AE	K5000S-LS
K6	Master kit w/o steels	G4/L5/PL5X (116mm)	1	86-90	AE	K5000F-LS
K7	O/H gasket set w/seals-rings	Integra CA/P1	1	86-89	AE	K50900S
K7	O/H gasket set w/seals-rings	G4/L5/PL5X	1	86-90	AE	K50900F
METAL CLAD SEALS						
A7	Seal, metal clad 35x68x5mm	Integra (CA/P1)	1	86-89	91207-639-015	50201
A7	Seal, metal clad 44x68x8mm	Legend (G4/L5/PL5X)	1	86-90	91207-PG4-005	50201A
F11	Seal, metal clad 40x76x9mm	Integra CA (bell housing)	1	86-87	91206-PC9-711	50209
F11	Seal, metal clad 40x56x9mm	Integra P1 (bell housing)	1	88-89	91205-PL3-B01	50210
F11	Seal, metal clad 40x56x9mm	Legend G4/L5/PL5X (left)	1	86-90	91206-PG2-005	50210
F12	Seal, metal clad 40x62x9mm	Integra CA (case)	1	86-87	91205-PC9-711	50208
F12	Seal, metal clad 40x76x9mm	Integra P1 (case)	1	88-89	91206-PC8-005	50209
F12	Seal, metal clad 40x56x9mm	Legend G4/L5/PL5X (right)	1	86-90	91206-PG2-005	50210
n/i	Seal, metal clad 12x22x7mm	CA/P1/G4/L5/PL5X	1	86-90	91209-612-003	46202
n/i	Seal, metal clad 9x18x7mm	CA/P1/G4/L5/PL5X	1	86-90	91201-PA9-003	50204
SEALING RINGS						
K10	Kit, sealing ring	Integra, Legend	1	86-90	AE	K50300C
A14	Ring, sealing large-metal 32mm	mainshaft for 110mm clutch 32mm	3	86-89	22814-PA9-023	50300C
A14	Ring, sealing-large-metal 35mm	mainshaft for 116mm clutch 35mm	4	86-90	22814-PF4-003	50300D
CLUTCH PLATES						
A15	Friction .075" 4.323" od 38T (110mm)	CA/P1 110mm (2nd clutch)	3	86-89	22544-PC9-010	50103D
A15	Friction .075" 4.570" od 41T (116mm)	G4/L5/PL5X 116mm (2nd clutch)	4	86-89	22544-PF4-010	50103E
A16	Steel .079" 3.230" id 8T (80mm)	CA/P1 (2nd clutch)	3	86-89	22543-PC9-000	50100D
A16	Steel .079" 3.230" id 8T (80mm)	G4/L5/PL5X (2nd clutch)	4	86-89	22543-PC9-000	50100D
B15	Friction .075" 4.323" od 38T (110mm)	CA/P1 110mm (4th clutch)	3	86-89	22544-PC9-010	50103D
B15	Friction .075" 4.570" od 41T (116mm)	G4/L5/PL5X 116mm (4th clutch)	4	86-89	22544-PF4-010	50103E
B16	Steel .079" 3.230" id 8T (80mm)	CA/P1 (4th clutch)	3	86-89	22543-PC9-000	50100D
B16	Steel .079" 3.230" id 8T (80mm)	G4/L5/PL5X (4th clutch)	4	86-89	22543-PC9-000	50100D
C15	Friction .075" 4.323" od 38T (110mm)	CA/P1 110mm (1st clutch)	3	86-89	22544-PC9-010	50103D
C15	Friction .075" 4.570" od 41T (116mm)	G4/L5/PL5X 116mm (1st clutch)	4	86-89	22544-PF4-010	50103E
C16	Steel .079" 3.230" id 8T (80mm)	CA/P1 (1st clutch)	3	86-89	22543-PC9-000	50100D
C16	Steel .079" 3.230" id 8T (80mm)	G4/L5/PL5X (1st clutch)	4	86-89	22543-PC9-000	50100D
D15	Friction .075" 4.323" od 38T (110mm)	CA/P1 110mm (3rd clutch)	3	86-89	22544-PC9-010	50103D
D15	Friction .075" 4.570" od 41T (116mm)	G4/L5/PL5X 116mm (3rd clutch)	4	86-89	22544-PF4-010	50103E
D16	Steel .079" 3.230" id 8T (80mm)	CA/P1 (3rd clutch)	3	86-89	22543-PC9-000	50100D
D16	Steel .079" 3.230" id 8T (80mm)	G4/L5/PL5X (3rd clutch)	4	86-89	22543-PC9-000	50100D
n/i	Steel .079" 3.152" id 8T (os) (80mm)	1st/2nd/3rd/4th clutch	sel	86-89	058711-210	50100DX
n/i	Steel .066" 3.152" id 8T (us) (80mm)	1st/2nd/3rd/4th clutch	sel	86-89	058711A	50106
n/i	Steel .063" 3.230" id 8T (us) (87mm)	1st/2nd/3rd/4th clutch	sel	86-89	058713	50100F
n/i	Steel .070" 3.152" id 10T (us) (87mm)	1st/2nd/3rd/4th clutch	sel	86-89	058721A	50108
n/i	Wave spring 1st/2nd/3rd/4th	replaces belleville spring w/110mm	1	86-90	058767-110	50150
n/i	Wave spring 1st/2nd/3rd/4th/1st hold	replaces belleville spring w/116mm	1	86-89	058767-116	50151
FILTERS						
F21	Filter, oil screen	Integra (CA) (disassembly required)	1	86-87	25420-PC9-010	50800D
F21	Filter, oil screen (disassembly required)	Legend (G4/L5/PL5X) (disassembly required)	1	86-89	25420-PL5-000	50800E
F21	Filter, oil screen	Integra (P1) (disassembly required)	1	88-89	25420-PL4-000	50800F

CA•P1•G4•L5•PL5X

CA•P1•G4•L5•PL5X

ILL	DESCRIPTION	QTY	YEAR	REFERENCE #	PART #
BUSHINGS					
K13	Kit, bushing	1	86-90	AE	K50901
WASHERS/BEARINGS/RACES/SHIMS					
D28	Bearing, thrust 52x35x2mm	1	86-89	91014-PA9-003	50501D
D29	Bearing, caged 38x32x24mm	1	86-87	91028-PF4-A01	50502
D32	Bearing, thrust 54x39x2mm	1	86-89	91031-PC9-003	50501E
A36	Bearing, thrust 56x36x2mm	1	86-87	91023-PG4-003	50501C
A36	Bearing, thrust 58x42x2mm	1	86-89	91026-PS5-003	50501B
A36	Bearing, thrust 56x36x2.5mm	1	86-90	91023-PG4-013	50501A
A38	Bearing, thrust 58x42x2mm	1	86-89	91026-PS5-003	50501B
A38	Bearing, thrust 56x36x2.5mm	1	87-90	91023-PG4-013	50501A
B41	Bearing, thrust 54x39x2mm	1	86-90	91031-PC9-003	50501E
HARD PARTS					
A52	Gear, mainshaft 2nd	1	86-89	23431-PHO-670	50418A
D62	Gear, countershaft 3rd	1	86-87	23451-PHO-000	50446
E66	Selector, reverse (shift sleeve)	1	86-89	23565-PC9-830	50436A
C70	Nut, mainshaft left hand thread 19mm	1	86-89	90201-PA9-000	50330
C70	Nut, right hand thread 23mm	1	86-89	91201-PG4-000	50331
C70	Nut, right hand thread 19mm	1	86-89	90201-PL4-000	50332
C70	Nut, right hand thread 23mm	1	89-90	91205-PL5-200	50333
E71	Nut, countershaft 20mm	1	86-89	90201-689-900	50334
E71	Nut 23mm	1	86-89	90202-PL5-000	50335
E71	Nut 24mm	1	88-90	90202-PL5-201	50336
n/i	Hub, repair (req. machining and welding)	1	86-90	A/E	50910
n/i	Hub, repair (req. machining and welding)	1	86-90	A/E	50911
n/i	Hub, repair (req. machining and welding)	1	86-90	A/E	50912
ELECTRICAL COMPONENTS					
F82	Solenoid, shift	1	86-89	28200-PL4-681	5A-712
F82	Solenoid, shift	1	87-90	28200-PL5-033	5A-713
F82	Solenoid, lock-up	1	87-90	28300-PL5-033	5A-714
SPRAGS					
E69	Sprag, assembly one way	1	86-89	23423-PA9-003	50503
E69	Sprag assembly one way	1	86-87	23423-PG4-003	50504
E69	Sprag assembly one way	1	88-90	23423-PL5-J00	50505
NOTES					

Your Most Valuable Tool to Fix TRANSMISSIONS



Thousands of transmission shops and general repair facilities worldwide count on the experienced staff and resources at ATSG to help them get the job done right and on time. All of ATSG's certified technicians have years of hands-on experience and are available to answer your tech problems on both foreign and domestic automatic transmissions.

In addition to our Technical Hotline, ATSG offers the latest Books, Software, Bulletins, Seminars and Technical Courses to the Automatic Transmission Professional.

So, stop turning away transmission repair work! ATSG is here to help you solve all your automatic transmission repair problems.

Call us today at (800) 245-7722

or visit us online at
www.atsg.biz

Try our pay per call option.

Become a Member Today & Take Advantage of...

- Our huge library which exceeds any single shop's library.
- Our "Superior Technical Hotline" which outranks the rest.
- 10 knowledgeable technicians which are there to assist you with any problems.
- The savings we provide by solving your transmission problems. One answered question can surpass the value of your subscription fee.



Expert Help is Just a Phone Call Away.

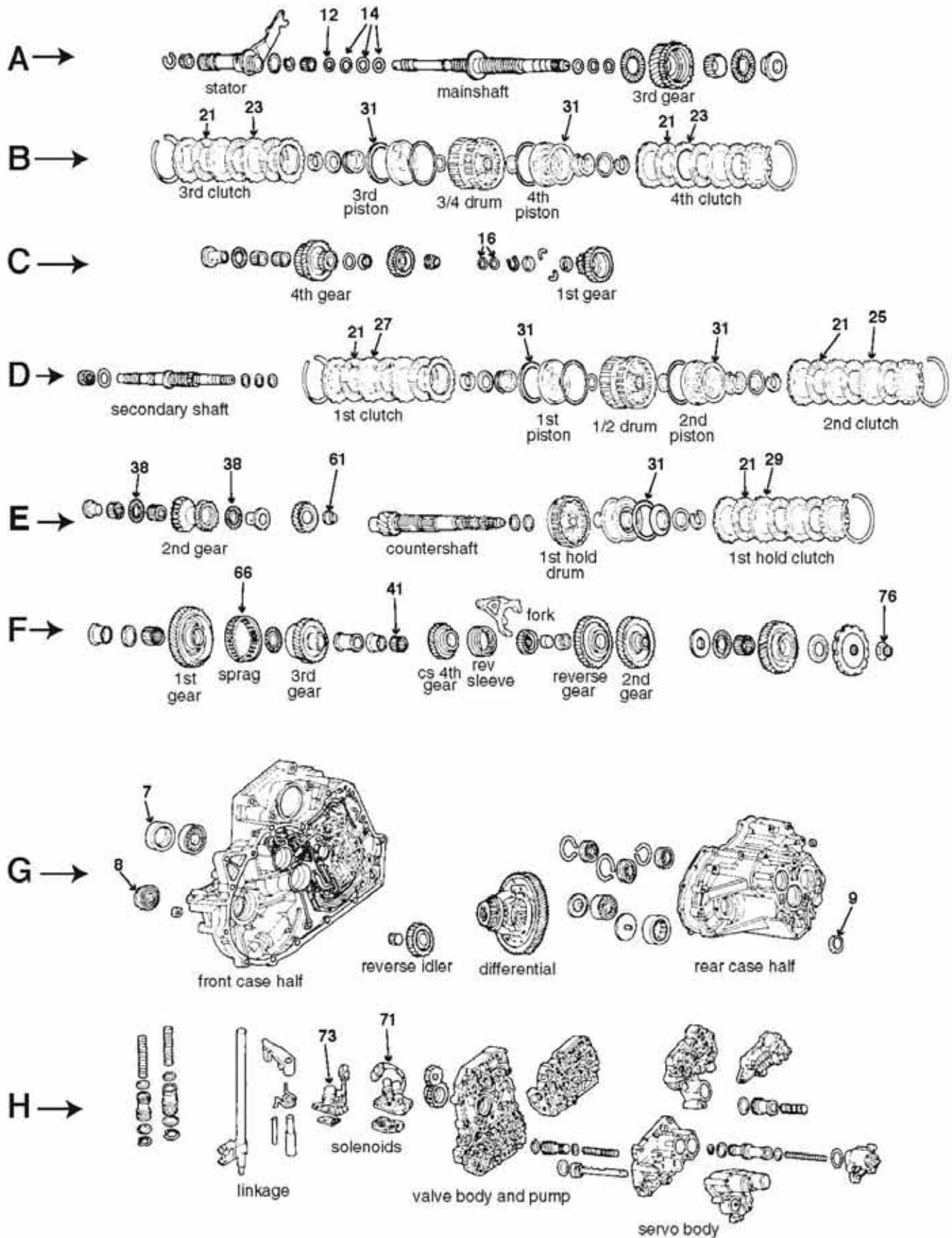

PX4B/MPXA/AOYA/APXA/APX4/MPOA/BOYA/MAXA/BAXA/MPJA/MDWAMP1A
50000N/R

ILL	DESCRIPTION		QTY	YEAR	REFERENCE #	PART #
TECHNICAL MANUALS						
K53	Tech manual PX4B 3-shaft dis/assembly	diagnosis/troubleshooting	1	90-92	83-HDA3SFTTM	010-454
K53	Tech manual M6HA/BAXA dis/assembly	diagnosis/troubleshooting	1	97-02	83-M6HA/BAXA-TM	010-458
REBUILDER KITS						
K5	Master kit w/steels	APXA-BOYA	1	90-97	AE	K5000N
K5	Master kit w/steels	BAXA/MAXA/M6HA/MDWA	1	97-02	AE	K5000R
K6	Master kit w/o steels	APXA-BOYA	1	90-97	AE	K5000N-LS
K6	Master kit w/o steels	BAXA/MAXA/M6HA/MDWA	1	97-02	AE	K5000R-LS
K7	O/H gasket set w/seals-rings	APXA-BOYA	1	90-97	AE	K50900N
K7	O/H gasket set w/seals-rings	BAXA/MAXA/M6HA/MDWA	1	97-02	AE	K50900R
METAL CLAD SEALS						
G7	Seal, metal clad 35x68x5mm	converter housing front seal	1	90-02	91207-POX-003	50201
G8	Seal, metal clad 40x56x9mm	axle bell housing	1	90-02	91206-PG2-005	50210
G8	Seal, metal clad 35x56x8mm	M6HA/MPJA/MDWA (axle bell housing)	1	95-98	91205-PX5-005	50211
G9	Seal, metal clad 40x66x8mm	all axle case	1	90-02	91206-PK4-003	50215
n/i	Seal, metal clad 12x22x7mm	manual lever seal	1	90-02	91209-612-003	46202
n/i	Seal, metal clad 9x18x7mm	throttle valve shaft	1	90-02	91201-PA9-005	50204
SEALING RINGS						
K10	Kit, sealing ring-metal	all	1	90-97	AE	K50300E
K10	Kit, sealing ring-teflon	all	1	97-02	AE	K50300J
A12	Ring, sealing-small-metal 29mm	mainshaft (all except below)	1	90-97	22814-PK4-003	50300E
A12	Ring, sealing-large-teflon 32mm	M6HA/MDWA (mainshaft)	1	97-01	22814-POX-003	50310
A12	Ring, sealing-small-teflon 29mm	BAXA/MAXA (mainshaft)	1	97-02	22815-PAX-005	50306
A14	Ring, sealing-large-metal 35mm	all mainshaft	3	90-96	22814-PF4-003	50300D
A14	Ring, sealing-large-teflon 35mm	MPOA/AOYA/MPJA (mainshaft)	3	97-97	22814-P4P-003	50307
A14	Ring, sealing-large-teflon 32mm	all mainshaft	3	97-02	22814-POX-003	50310
C16	Ring, sealing large-metal 32mm	all secondary shaft	2	90-96	22814-PA9-023	50300C
C16	Ring, sealing-large-teflon 32mm	MPOA/AOYA/MPJA (secondary shaft)	2	97-97	22814-POX-003	50310
C16	Ring, sealing-plastic 35mm	all secondary shaft	2	97-02	22816-P6H-003	50312
CLUTCH PLATES						
B21	Friction .076" 4.728" od 44T	APXA-BOYA (3rd clutch)	4	90-97	22544-PX4-013	50105
B21	Friction .076" 4.728" od 44T	BAXA/MAXA/M6HA/MDWA (3rd clutch)	4	97-02	22544-PX4-013	50105
B22	Steel .091" 3.664" id 24T	APXA-BOYA (3rd clutch)	4	90-97	22653-PX4-003	50114
B22	Steel .102" 3.664" id 24T	BAXA/MAXA/M6HA/MDWA (3rd clutch)	4	97-02	22644-PX4-013	50112
B23	Friction .076" 4.728" od 44T	APXA-BOYA (4th clutch)	3	90-97	22544-PX4-013	50105
B23	Friction .076" 4.728" od 44T	BAXA/MAXA/M6HA/MDWA (4th clutch)	4	97-02	22544-PX4-013	50105
B24	Steel .091" 3.664" id 24T	APXA-BOYA (4th clutch)	3	90-97	22653-PX4-003	50114
B24	Steel .091" 3.664" id 24T	BAXA/MAXA/M6HA/MDWA (4th clutch)	4	97-02	22653-PX4-003	50114
D25	Friction .076" 4.728" od 44T	APXA-BOYA (1st clutch)	3	90-97	22544-PX4-013	50105
D25	Friction .075" 4.570" od 44T	BAXA/MAXA/M6HA/MDWA (1st clutch)	6	97-02	22545-P6H-003	50139
D26	Steel .079" 3.664" id 24T	APXA-BOYA (1st clutch)	3	90-97	22543-PX4-003	50110
D26	Steel .079" 3.585" id 24T	BAXA/MAXA/M6HA/MDWA (1st clutch)	6	97-02	22523-P6H-003	50144
D27	Friction .076" 4.728" od 44T	APXA-BOYA (2nd clutch)	4	90-97	22544-PX4-013	50105
D27	Friction .075" 4.570" od 44T	BAXA/MAXA/M6HA/MDWA (2nd clutch)	6	97-02	22545-P6H-003	50139
D28	Steel .102" 3.664" id 24T	Exc Prelude W/H23 engine (2nd clutch)	4	90-96	22644-PX4-013	50112
D28	Steel .063" 3.585" id 24T	M6HA (2nd clutch)	6	97-02	22543-P6H-003	50142
D28	Steel .063" 3.664" id 24T	BAXA/MAXA/MDWA (2nd clutch)	6	97-02	22543-P6H-901	50142A
E21	Friction .076" 4.728" od 44T	1st hold clutch	3	97-02	22544-PX4-013	50105
E29	Steel .079" 3.664" id 24T	1st hold clutch	3	90-94	22543-PX4-003	50110
E29	Steel .063" 3.664" id 24T	1st hold clutch	4	95-97	22543-POX-003	50140
n/i	Steel .070" 3.664" id 24T us)	all	ar	90-97	078701A	50110U
n/i	Steel .083" id 24T (os)	all	ar	90-97	078701-210	50110X
n/i	Wave spring 1st/2nd/3rd/4th/low hold	replaces Belleville spring w/120 mm	1/4	90-96	058701A	50152

APXA•APX4•MPXA•MPWA•MPOA•AOYA•BOYA•BAXA•MAXA•MP1A•M6HA•MPJA•MDWA•PX4B



*Add Some Muscle
to Your
Rebuilds ...*

**Muscle MT-10...
"The Original" Metal Treatment™**

- ✓ Lowers Operating Temperatures
- ✓ Frees Valve Body for Optimum Performance
- ✓ Eliminates Governor Hang-Ups Caused by Contamination & Surface Spiking
- ✓ Keeps Oil Passages, Orifices & Ball Checks Clean & Fully Operational
- ✓ Extends the life of the Transmission by Eliminating Premature Failure with Improved Lubrication
- ✓ Reduces Metal Particle Fallout & Debris Caused by Friction & Wear
- ✓ Removes Varnish Buildup
- ✓ Nearly Eliminates Lock-Up Chatter in the Torque Converter
- ✓ Insures Proper Shifts

**Muscle Products Corp.
"The Strength in Lubrication"®**

752 Kilgore Road
Jackson Center, PA 16133 U.S.A.

Phone: 800-227-7049

814-786-0166

Fax: 814-786-7321

Web Site: www.mpclubricants.com

Email: sales@mpclubricants.com



*Serving
transmission
specialists
since 1986*



*...The Key to
Reducing Costly
Come Backs*

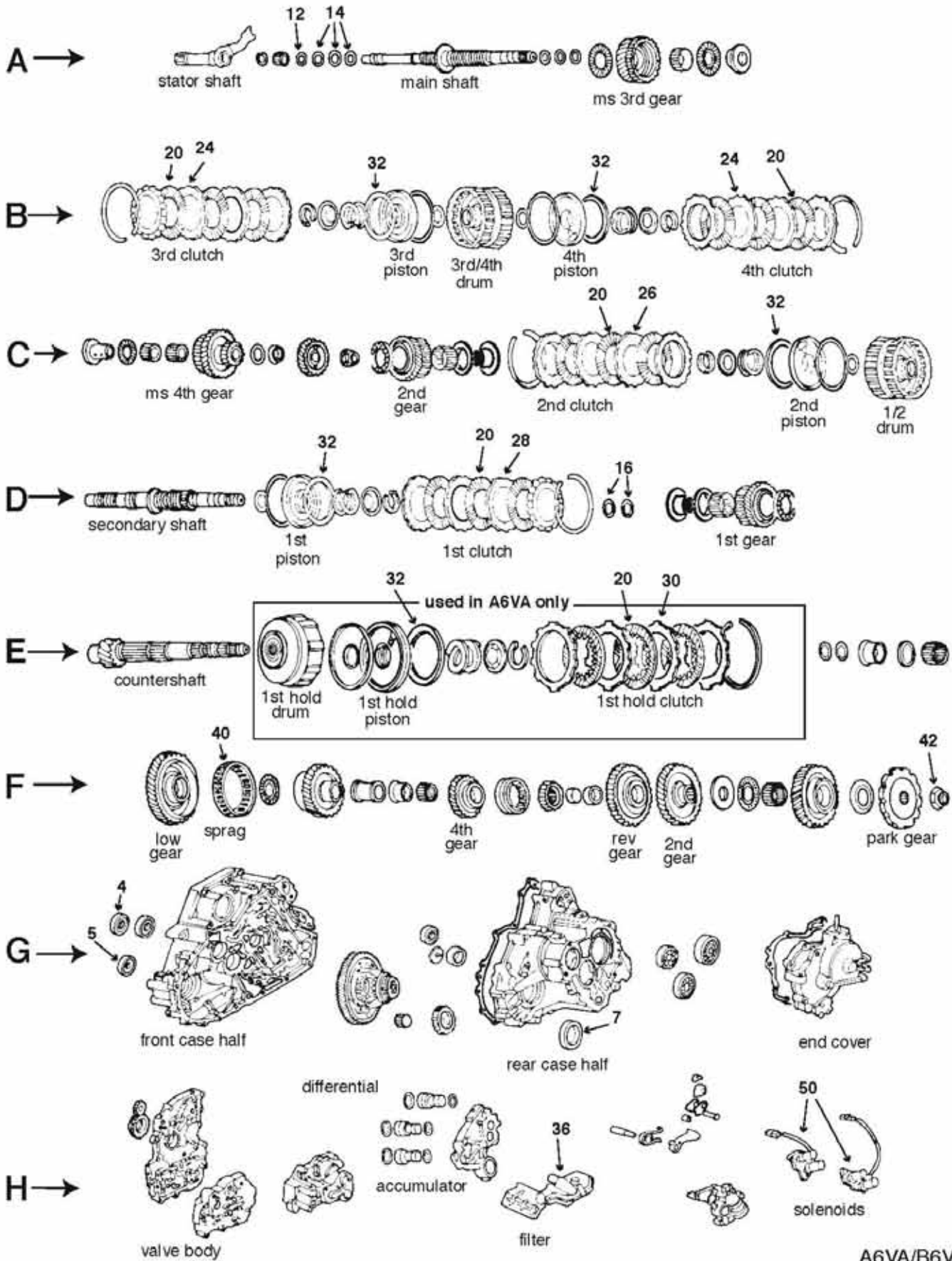

A6VA/B6VA
50000N/R

ILL	DESCRIPTION	QTY	YEAR	REFERENCE #	PART #
REBUILDER KITS					
K5	Master kit w/steels A6VA CL 2.2L	1	96-97	AE	K5000N
K5	Master kit w/steels B6VA CL 2.3L	1	98-99	AE	K5000R
K6	Master kit w/o steels A6VA CL 2.2L	1	96-97	AE	K5000N-LS
K6	Master kit w/o steels B6VA CL 2.3L	1	98-99	AE	K5000R-LS
K7	O/H gasket set w/seals-rings A6VA CL 2.2L	1	96-97	AE	K50900N
K7	O/H gasket set w/seals-rings B6VA CL 2.3 L	1	98-99	AE	K50900R
METAL CLAD SEALS					
G4	Seal, metal clad 35x68x5mm A6VA/B6VA (front seal)	1	96-99	91207-POX-003	50201
G5	Seal, metal clad 40x56x9mm A6VA/B6VA (bell housing/axle)	1	96-99	91206-PG2-005	50210
G7	Seal, metal clad 40x66x8mm A6VA/B6VA (case/axle)	1	96-99	91206-PK4-003	50215
n/i	Seal, metal clad 12x22x7mm A6VA/B6VA (lever seal)	1	96-99	91209-612-003	46202
n/i	Seal, metal clad 9x18x7mm A6VA/B6VA (TV shaft seal)	1	96-99	91201-PA9-004	50204
SEALING RINGS					
K10	Kit, sealing ring A6VA	1	96-97	AE	K50300P
K10	Kit, sealing ring-teflon B6VA	1	98-99	AE	K50300J
A12	Ring, sealing-small-teflon 29mm A6VA/B6VA (mainshaft)	1	96-99	22815-P4P-003	50306
A14	Ring, sealing-large-teflon 35mm A6VA	3	96-97	22814-P4P-003	50307
A14	Ring, sealing-large-teflon 32mm B6VA (mainshaft)	2	98-99	22814-PAX-005	50310
D16	Ring, sealing-large-teflon 32mm A6VA (secondary shaft)	2	96-97	22814-POX-003	50310
D16	Ring, sealing-plastic 35mm B6VA (secondary shaft)(not in kits)	2	98-99	22816-P6H-003	50312
CLUTCH PLATES					
B20	Friction .076" 4.728" od 44T A6VA (3rd clutch)	4	96-97	22544-POX-003	50105
B20	Friction .075" 4.570" od 44T B6VA (3rd clutch)	4	98-99	22544-PAX-003	50139
B21	Steel .091" 3.664" id 24T A6VA (3rd clutch)	4	96-99	22656-P7Z-003	50114
B21	Steel .102" 3.664" id 24T B6VA (3rd clutch)	4	98-99	22644-PX4-013	50112
B22	Steel .091" 3.664" id 24T A6VA (4th clutch)	3	96-97	22656-P7Z-003	50114
B22	Steel .091" 3.664" id 24T B6VA (4th clutch)	4	98-99	22656-P7Z-003	50114
B23	Friction .076" 4.728" od 44T A6VA (4th clutch)	3	96-97	22544-POX-003	50105
B23	Friction .076" 4.728" od 44T B6VA (4th clutch)	4	98-99	22544-POX-003	50105
C24	Friction .076" 4.728" od 44T A6VA (2nd clutch)	4	96-97	22544-POX-003	50105
C24	Friction .075" 4.570" od 44T B6VA (2nd clutch)	6	98-99	22545-PAX-003	50139
C25	Steel .102" 3.664" id 24T A6VA (2nd clutch)	4	96-97	22644-PX4-013	50112
C25	Steel .063" 3.585" id 24T B6VA (2nd clutch)	6	98-99	22543-P6H-003	50142
D26	Friction .076" 4.728" od 44T A6VA (1st clutch)	3	96-97	22544-POX-003	50105
D26	Friction .075" 4.570" od 44T B6VA (1st clutch)	6	98-99	22545-PAX-003	50139
D27	Steel .079" 3.664" id 24T A6VA (1st clutch)	3	96-97	22543-PX4-003	50110
D27	Steel .083" id 24T (os) A6VA (1st clutch)	ar	96-97	078701-210	50110X
D27	Steel .079" 3.585" id 24T B6VA (1st clutch)	6	98-99	22523-P6H-003	50144
E28	Friction .076" 4.728" od 44T A6VA (1st hold clutch)	3	96-97	22544-POX-003	50105
E29	Steel .063" 3.664" id 24T A6VA (1st hold clutch)	3	96-97	22543-POX-003	50140
D29	Steel .070" 3.664" id 24T us) A6VA/B6VA (1st/2nd/3rd/4th/1st hold cl)	ar	96-99	078701A	50110U
E32	Wave spring 1st/2nd/3rd/4th/low hold replaces beveled spring w/120 mm	1/5	96-99	078701A	50152
FILTERS					
H36	Filter, oil screen (disassembly required) A6VA (disassembly required)	1	96-97	25420-PX4-701	50800Q
H36	Filter, oil screen (disassembly required) B6VA (disassembly required)	1	98-99	25420-PAX-003	50800L
BUSHINGS					
K13	Kit, bushing A6VA	1	96-97	AE	K50901B
K13	Kit, bushing B6VA	1	98-99	AE	K50901C
HARD PARTS					
F42	Nut A6VA (counter shaft and secondary shaft)	2	96-97	90203-PX4-010	50338

WOULD THE PRODUCTS WITH THE OEM APPROVED TECHNOLOGY PLEASE STAND UP?



Call for your **FREE** copy



LUBEGARD is the **only product** in its class that has been the written solution in **EIGHT OEM** service bulletins.

If OEM's use LUBEGARD, shouldn't you?

www. **LUBEGARD**.com



INTERNATIONAL LUBRICANTS, INC.
 7930 Occidental South • Seattle, WA 98108 • PO Box 24743 • Seattle, WA 98124
 206-762-5343 • 800-333-LUBE (5823) • Fax: 206-762-7989 • www.Lubegard.com

©2010 International Lubricants, Inc. All rights reserved. All trademarks are property of their respective owners.

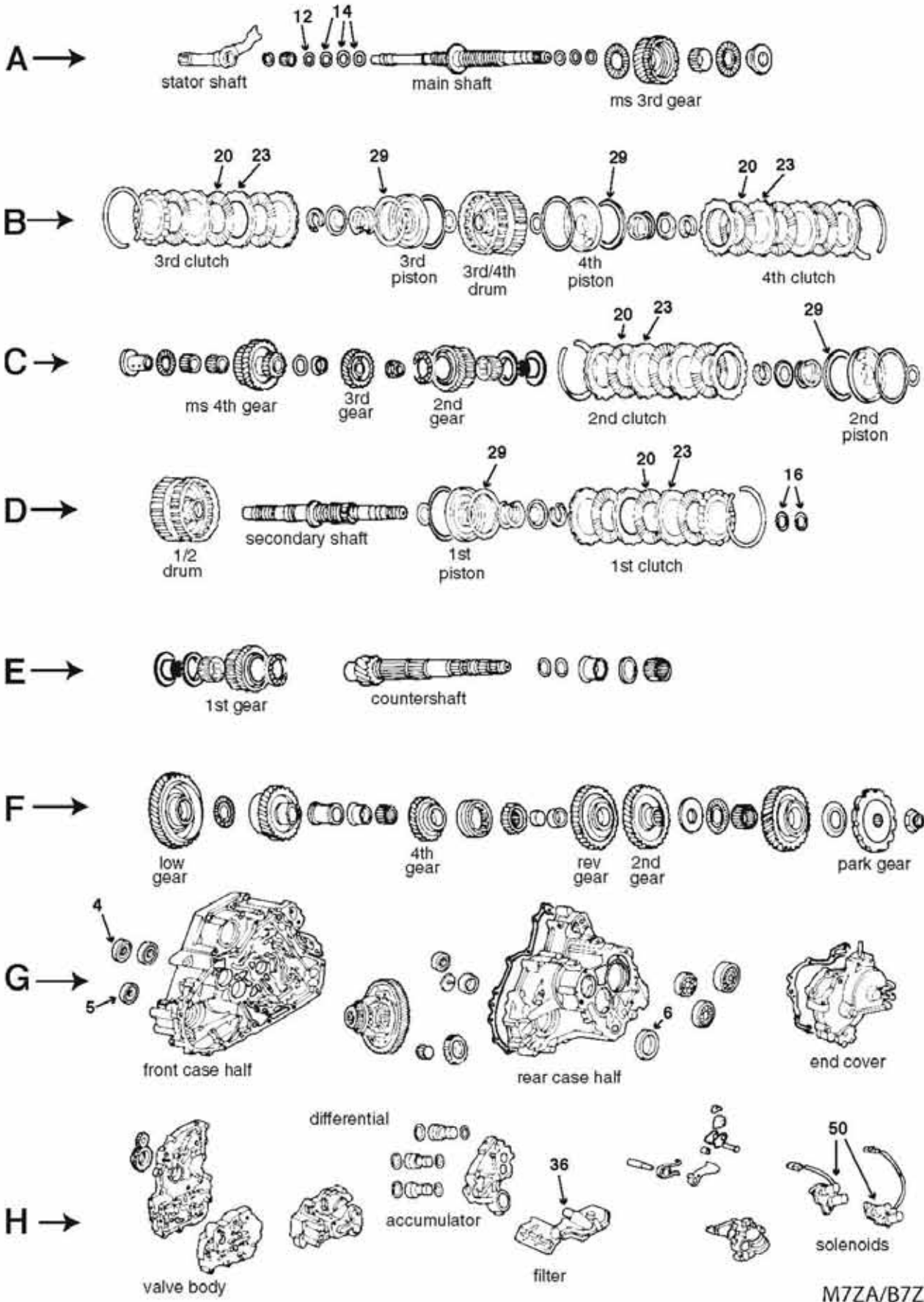

M7ZA/B7ZA/B7VA
50000J/JA/Q

ILL	DESCRIPTION	QTY	YEAR	REFERENCE #	PART #
REBUILDER KITS					
K5	Master kit w/steels M7ZA/B7ZA	1	96-99	AE	K5000J
K5	Master kit w/steels B7VA	1	99-99	AE	K5000Q
K6	Master kit w/o steels M7ZA/B7ZA	1	96-99	AE	K5000J-LS
K6	Master kit w/o steels B7VA	1	99-99	AE	K5000Q-LS
K7	O/H gasket set w/seals-rings M7ZA/B7VA/B7ZA	1	96-99	AE	K50900B
GASKETS AND RUBBER COMPONENTS					
n/i	O'ring, converter hub 31.98mm 1.9mm	1	83-07	B17535	23042
n/i	O'ring, converter hub 35.5mm 1.9mm	1	86-07	B17928	23043
METAL CLAD SEALS					
G4	Seal, metal clad 44x68x8mm front seal	1	96-99	91207-P7Z-003	50201A
G5	Seal, metal clad 40x56x9mm bell housing axle	1	96-99	91206-POZ-005	50210
G7	Seal, metal clad 35x54x8mm case axle	1	96-99	91205-POX-005	50228
n/i	Seal, metal clad 12x22x7mm manual lever shaft	1	96-99	91209-612-003	46202
n/i	Seal, metal clad 9x18x7mm throttle shaft	1	96-99	91201-PA9-004	50204
SEALING RINGS					
K10	Kit, sealing ring-teflon M7ZA/B7VA	1	96-99	AE	K50300J
A12	Ring, sealing-small-teflon 29mm mainshaft	1	96-99	22815-PAX-005	50306
A14	Ring, sealing-large-teflon 32mm mainshaft	3	96-99	22814-POX-003	50310
D16	Ring, sealing-plastic 35mm secondary shaft	2	96-99	22816-P6H-003	50312
CLUTCH PLATES					
B20	Friction .076" 4.728" od 44T M7ZA/B7ZA (3rd clutch)	4	96-99	22545-POZ-003	50105
B20	Friction .077" 5.043" od 44T B7VA (3rd clutch)	4	99-99	22644-P7T-003	50135
B23	Steel .091" 3.664" id 24T M7ZA/B7ZA (3rd clutch)	4	96-99	22656-P7Z-003	50114
B23	Steel .091" 3.664" id 20T B7VA (3rd clutch)	4	99-99	22656-P7T-003	50136
B20	Friction .076" 4.728" od 44T M7ZA/B7ZA (4th clutch)	4	96-99	22545-POZ-003	50105
B20	Friction .077" 5.043" od 44T B7VA (4th clutch)	4	99-99	22644-P7T-003	50135
B23	Steel .091" 3.664" id 24T M7ZA/B7ZA (4th clutch)	4	96-99	22656-P7Z-003	50114
B22	Steel .078" 3.664" id 20T (narrow teeth) B7VA (4th clutch)	4	99-99	22653-P7T-003	50138
C20	Friction .076" 4.728" od 44T M7ZA/B7ZA (2nd clutch)	4	96-99	22545-POZ-003	50105
C20	Friction .077" 4.846" od 44T B7VA (2nd clutch)	6	99-99	22544-P7T-003	50131
C22	Steel .102" 3.664" id 24T M7ZA/B7ZA (2nd clutch)	4	96-99	22644-PX4-013	50112
C22	Steel .078" 3.664" id 20T (wide teeth) B7VA (2nd clutch)	6	99-99	22543-P7T-003	50134
D20	Friction .076" 4.728" od 44T M7ZA/B7ZA (1st clutch)	4	96-99	22545-POZ-003	50105
D20	Friction .077" 4.846" od 44T B7VA (1st clutch)	6	99-99	22544-P7T-003	50131
D22	Steel .079" 3.664" id 24T M7ZA/B7ZA (1st clutch)	4	96-99	22653-P7Z-003	50110
D22	Steel .078" 3.664" id 20T (wide teeth) B7VA (1st clutch)	6	99-99	22543-P7T-003	50134
n/i	Steel .083" id 24T (os) M7ZA/B7ZA (1st/2nd/3rd/4th clutch)	sel	96-99	078701-210	50110X
n/i	Steel .070" 3.664" id 24T us) M7ZA/B7ZA (1st/2nd/3rd/4th clutch)	sel	96-99	078701A	50110U
n/i	Wave spring 1st/2nd/3rd/4th/low hold replaces belleville spring w/120 mm	1/4	99-99	078767	50152
FILTERS					
H36	Filter, oil screen M7ZA (disassembly required)	1	96-97	25420-P7Z-000	50800G
H36	Filter, oil screen (disassembly required) B7VA (disassembly required)	1	99-99	25420-P7X-003	50800H
BUSHINGS					
K13	Kit, bushing M7ZA/B7ZA/B7VA	1	96-99	AE	K50901C
ELECTRICAL COMPONENTS					
H50	Solenoid, shift and lock-up M7ZA/B7VA	1	96-99	28200-POZ-003	5A-729
H50	Solenoid, linear M7ZA	1	96-97	28250-P7Z-305	5A-730
H50	Solenoid, linear B7VA	1	99-99	28250-P6H-024	5A-731
H50	Solenoid, lock-up B7VA (shift and lock-up)	1	99-99	28300-PX4-003	5A-734
H50	Solenoid, shift (linear) black connector B7VA (black connector)	1	99-99	28400-P6H-003	5A-738
H50	Solenoid, shift (linear) brown connector B7VA (brown connector)	1	99-99	28500-P6H-003	5A-739
NOTES					

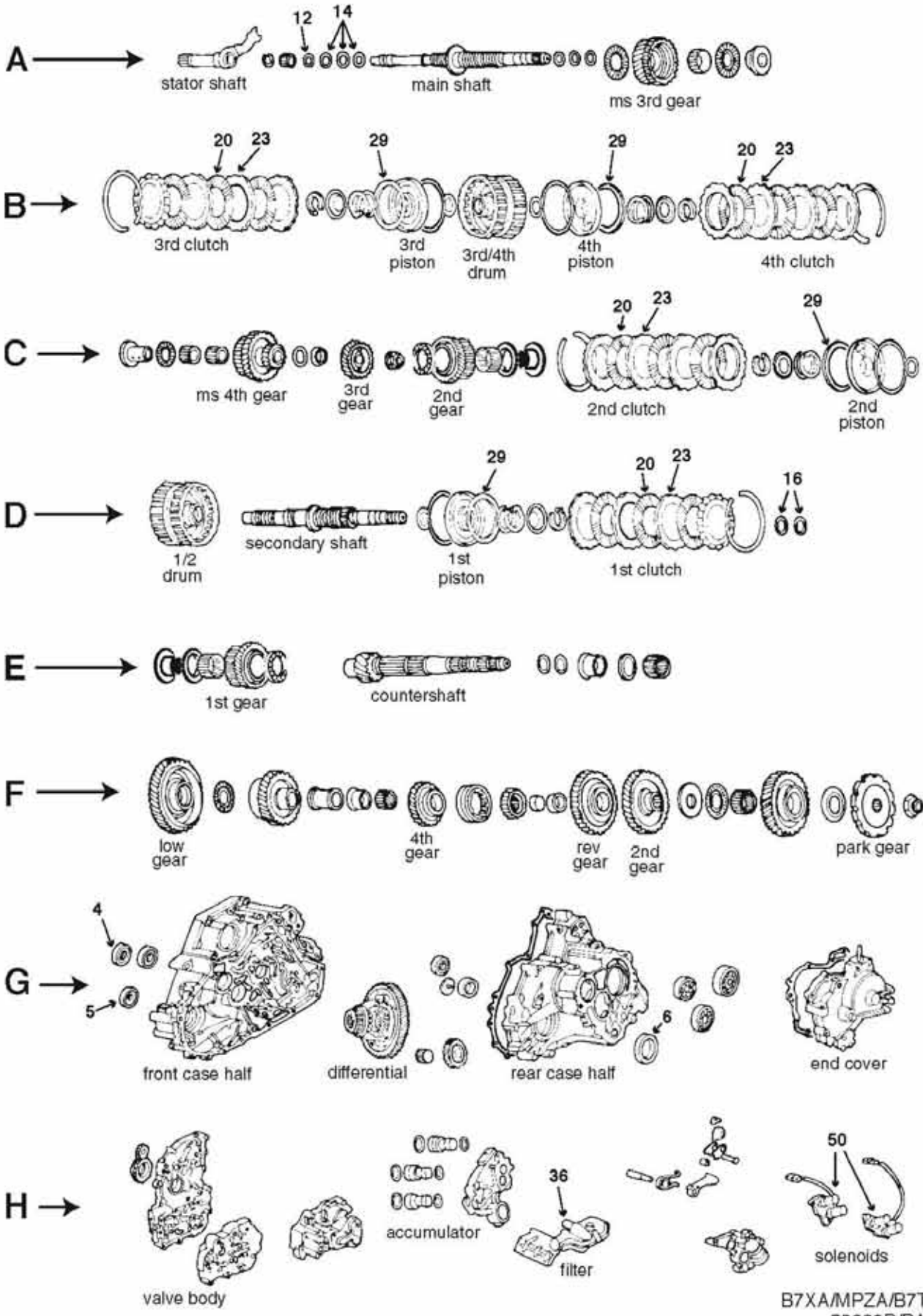

B7XA/MPZA/B7TA/B7YA
50000B/BA/Q

ILL	DESCRIPTION	QTY	YEAR	REFERENCE #	PART #
REBUILDER KITS					
K5	Master kit w/steels MPZA	1	95-97	AE	K5000B
K5	Master kit w/steels B7XA	1	98-02	AE	K5000BA
K5	Master kit w/steels B7TA/B7YA	1	99-05	AE	K5000Q
K6	Master kit w/o steels MPZA	1	95-97	AE	K5000B-LS
K6	Master kit w/o steels B7XA	1	98-02	AE	K5000BA-LS
K6	Master kit w/o steels B7TA/B7YA	1	99-05	AE	K5000Q-LS
K7	O/H gasket set w/seals-rings MPZA/B7XA/B7TA/B7YA/B7VA	1	95-05	AE	K50900B
METAL CLAD SEALS					
G4	Seal, metal clad 44x68x8mm converter (front seal)	1	95-05	91207-PG4-005	50201A
G5	Seal, metal clad 35x54x8mm bell housing axle	1	95-05	91207-PH8-005	50228
G6	Seal, metal clad 40x56x9mm case axle	1	95-05	91206-PG2-005	50210
n/i	Seal, metal clad 12x22x7mm manual lever (shift shaft)	1	95-05	91209-612-003	46202
n/i	Seal, metal clad 9x18x7mm throttle valve shaft (TV shaft)	1	95-05	91201-PA9-003	50204
SEALING RINGS					
K10	Kit, sealing ring-metal all	1	95-02	AE	K50300E
K10	Kit, sealing ring-teflon all	1	98-02	AE	K50300J
A12	Ring, sealing-small-metal 29mm mainshaft	1	95-02	22814-PK4-003	50300E
A12	Ring, sealing-small-teflon 29mm mainshaft	1	98-02	22815-PAX-005	50306
A14	Ring, sealing large-metal 32mm mainshaft	3	95-02	22814-PA9-023	50300C
A14	Ring, sealing-large-teflon 32mm mainshaft	3	98-02	22814-PAX-005	50310
D16	Ring, sealing-large-metal 35mm secondary shaft	2	95-02	22814-PF4-003	50300D
D16	Ring, sealing-plastic 35mm secondary shaft	2	98-02	22816-P6H-003	50312
CLUTCH PLATES					
B20	Friction .076" 4.728" od 44T MPZA (3rd clutch)	4	95-97	22245-POZ-003	50105
B20	Friction .076" 4.728" od 44T B7XA (3rd clutch)	4	98-02	22544-P7Z-003	50105
B20	Friction .077" 5.043" od 44T B7TA/B7YA (3rd clutch)	4	99-05	22644-P7T-003	50135
B23	Steel .079" 3.664" id 24T MPZA (3rd clutch)	4	95-97	22543-PX4-003	50110
B23	Steel .091" 3.664" id 24T B7XA (3rd clutch)	4	98-02	22656-P7Z-003	50114
B23	Steel .091" 3.664" id 20T B7TA/B7YA (3rd clutch)	4	99-05	22656-P7T-003	50136
B24	Friction .076" 4.728" od 44T MPZA (4th clutch)	4	95-97	22245-POZ-003	50105
B24	Friction .076" 4.728" od 44T B7XA (4th clutch)	4	98-02	22245-POZ-003	50105
B24	Friction .077" 5.043" od 44T B7TA/B7YA (4th clutch)	4	99-05	22644-P7T-003	50135
B25	Steel .079" 3.664" id 24T MPZA (4th clutch)	4	95-97	22653-P7Z-003	50110
B25	Steel .079" 3.664" id 24T B7XA (4th clutch)	4	98-02	22653-P7Z-003	50110
B23	Steel .078" 3.664" id 20T (narrow teeth) B7TA/B7YA (4th clutch)	4	99-05	22653-P7T-003	50138
C26	Friction .076" 4.728" od 44T MPZA (2nd clutch)	5	95-97	22245-POZ-003	50105
C26	Friction .076" 4.728" od 44T B7XA (2nd clutch)	6	98-02	22245-POZ-003	50105
C26	Friction .077" 4.846" od 44T B7TA/B7YA (2nd clutch)	6	99-05	22544-P7T-003	50131
C27	Steel .079" 3.664" id 24T MPZA (2nd clutch)	5	95-97	22653-P7Z-003	50110
C27	Steel .079" 3.664" id 24T B7XA (2nd clutch)	6	98-02	22653-P7Z-003	50110
C27	Steel .078" 3.664" id 20T (wide teeth) B7TA/B7YA (2nd clutch)	6	99-05	22543-P7T-003	50134
D28	Friction .076" 5.190" od 49T MPZA (1st clutch)	4	95-97	22544-POZ-003	50141
D28	Friction .076" 4.728" od 44T B7XA (1st clutch)	4	98-02	22245-POZ-003	50105
D28	Friction .077" 4.846" od 44T B7TA/B7YA (1st clutch)	6	99-05	22544-P7T-003	50131
D29	Steel .079" 4.058" id 18T MPZA (1st clutch)	4	95-97	22543-POZ-003	50132
D29	Steel .071" 4.058" 18T (undersize) MPZA (1st clutch)	ar	95-97	116703-180	50132U
D29	Steel .083" 4.058" 18T (oversize) MPZA (1st clutch)	ar	95-97	116703-220	50132X
D29	Steel .079" 3.664" id 24T B7XA (1st clutch)	4	98-02	22653-P7Z-003	50110
D29	Steel .078" 3.664" id 20T (wide teeth) B7YA/B7TA (1st clutch)	6	99-05	22543-P7T-003	50134
n/i	Friction .076" 4.570" od 44T MPZA (low hold clutch)	3	95-97	22674-POZ-003	50146
n/i	Steel .079" 3.664" id 6T MPZA (low hold clutch)	2	95-97	22683-POZ-003	50148
n/i	Steel .063" 3.664" id 6T MPZA (low hold clutch)	ar	95-97	22681-POZ-003	50156
n/i	Steel .087" 3.664" id 6T MPZA (low hold clutch)	ar	95-97	22684-POZ-003	50160

A Great Product Becomes A SUPERIOR Product!

Innovative Technology for the 21st Century

TransLab

TL-175

FIXES:

2-3 flare, 4-2 neutral, downshift clunks, slips or neutrals in 4th, end clutch failure, slip 1-2 and much more...

PROVIDES:

shorter shifts, extended clutch and band life, improved cooler flow, lube & lockup operation

SHIFT

TECHNOLOGY PRODUCTS
A DIVISION OF SUPERIOR TRANSMISSION PARTS, INC.

TransLab
ENGINEERED

Innovative Technology for the 21st Century

THE HIGHEST QUALITY AFTERMARKET PARTS AVAILABLE-EASY TO INSTALL

SUPERIOR
TRANSMISSION PARTS, INC.
THE SIMPLE SOLUTION

Translab became famous for their reliable and effective KM upgrade kits which are all now available from SUPERIOR.

The 175 TransLab Valve Body Upgrade Kit Corrects or Prevents:

- 2-3 Flair
- Coast Downshift Clunks
- End Clutch Failure
- Part Throttle 3-2 Bang
- 4-2 Neutral
- Slips or Neutrals in 4th
- Slide 1-2
- 3rd Gear Starts

Part# STL-175

The 175-6 TransLab Valve Body Upgrade Kit Corrects or Prevents:

- 2-3 Flair
- Slide 1-2
- Part Throttle 3-2 Bang
- Coast 3-2 Clunk
- 4-2 Kick-down Runaway
- Delayed/Soft/Slow N-D Engage
- Delay Reverse
- Mushy 2-3

Part# STL-175-6

The 175-HP TransLab Valve Body Upgrade Kit Corrects or Prevents:

- 2-3 Flair
- Coast Downshift Clunks
- Long Soft Slide Shifts
- Part Throttle 3-2 Bang
- Hits Rev Limiter at Full Throttle (Driver must Lift Foot to get 2-3 Shift)
- Slide 1-2
- 3rd Gear Starts

Part# STL-175-HP

Try The Other Great Translab Products By Superior
STL-F4A-CPR • STL-540E • STL-4L30 • STL-400-5 • STL-RE5

Coming Soon

SUPERIOR
TRANSMISSION PARTS, INC.
THE SIMPLE SOLUTION™

800-451-3115
www.superiortransmission.com

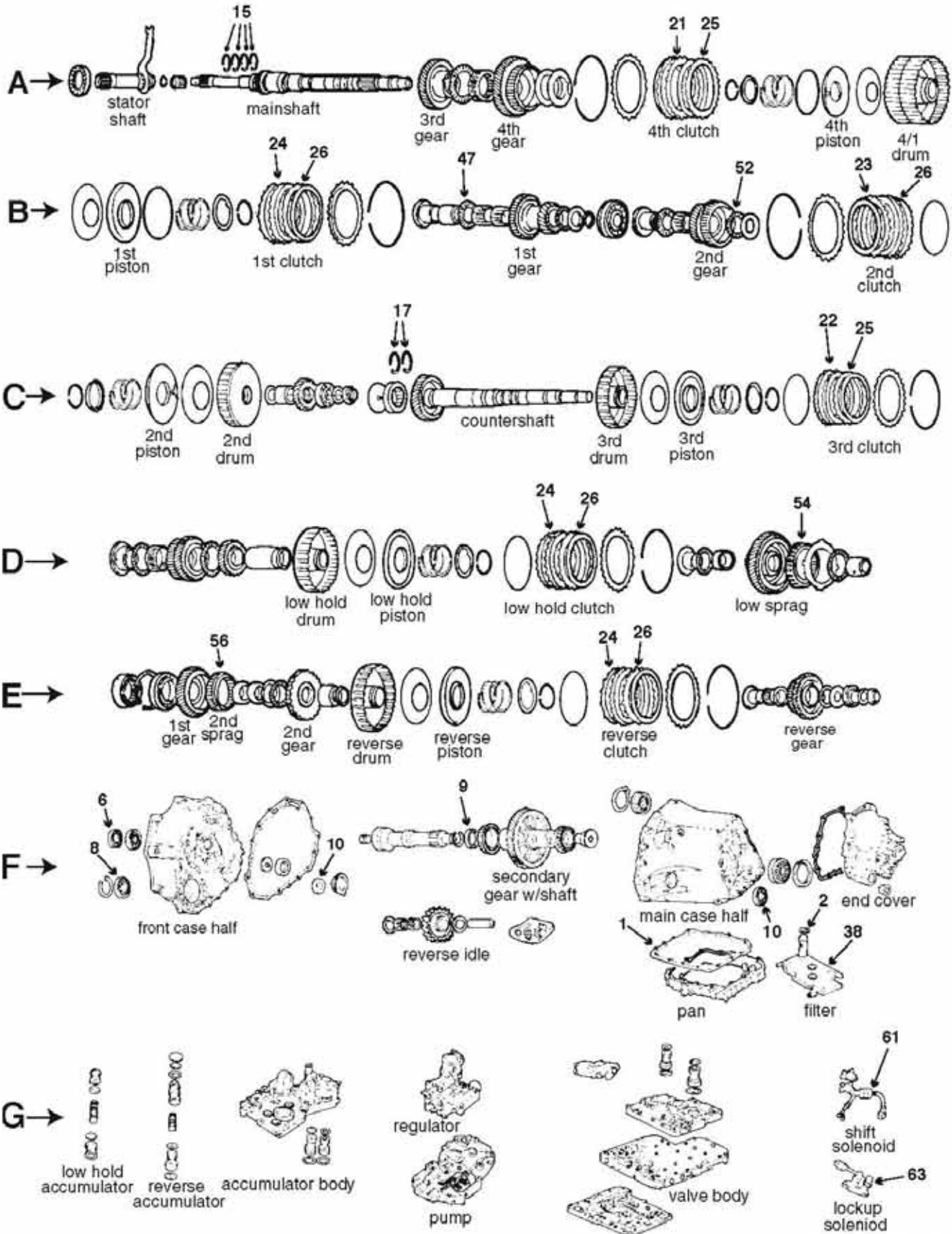

MPYA/M5HA/M5DA
5000T

ILL	DESCRIPTION	QTY	YEAR	REFERENCE #	PART #
TECHNICAL MANUALS					
n/i	Tech manual Legend MPYA dis/assembly diagnosis/troubleshooting	1	91-03	83-LEG1991TM	010-441
REBUILDER KITS					
K5	Master kit w/steels B7VA/MPYA/M5HA/M5DA	1	91-03	AE	K5000T
K6	Master kit w/o steels B7VA/MPYA/M5HA/M5DA	1	91-03	AE	K5000T-LS
K7	O/H gasket set w/seals-rings B7VA/MPYA/M5HA/M5DA	1	91-03	AE	K50900T
GASKETS AND RUBBER COMPONENTS					
F1	Gasket, pan Legend (MPYA) Duraprene®	1	91-95	21813-PY4-000	14026D
F1	Gasket, pan M5HA/M5DA (3.2TL/3.5RL) Duraprene®	1	96-03	21813-P5H-003	14027D
F2	O'ring, filter B7VA/MPYA/M5HA/M5DA	1	91-03	31308-PA9-003	13023
METAL CLAD SEALS					
F6	Seal, metal clad 46x70x8mm front seal	1	91-03	91207-PR9-003	50201B
F8	Seal, metal clad 55x75x11mm front secondary shaft	1	91-03	91201-PY5-005	50216
F9	Seal, metal clad 37x47x7mm inner secondary shaft	1	91-03	91202-PY5-005	50217
F10	Seal, metal clad 45x61x8mm rear secondary shaft	1	91-03	91205-PY5-005	50218
n/i	Seal, metal clad 42x63x9mm right differential (axle)	1	91-03	91206-PY4-004	50219
n/i	Seal, metal clad 56x75x10mm rear differential (pinion)	1	91-03	91209-PY4-003	50220
n/i	Seal, metal clad 12x22x7mm shift shaft	1	91-03	91209-612-003	46202
n/i	Seal, metal clad 9x18x7mm throttle shaft	1	91-03	91201-PA9-003	50204
SEALING RINGS					
K10	Kit, sealing ring MPYA/M5HA/M5DA	1	91-03	AE	K50300T
A15	Ring, sealing metal 37mm MPYA (mainshaft)	4	91-95	22814-PR9-003	50302
A15	Ring, sealing 37mm M5HA/M5DA (mainshaft)	4	96-03	22814-P5N-003	50303
C17	Ring, sealing 42mm MPYA (countershaft)	2	91-95	22814-PY4-003	50304
C17	Ring, sealing 42mm M5HA,M5DA (countershaft)	2	96-03	22815-P5H-003	50305
CLUTCH PLATES					
A21	Friction 45T .093" 5.041" od (125mm) 4th clutch	5	91-03	22654-PY4-501	50123
A25	Steel 20T .102" 3.756" id (95mm) 4th clutch	5	91-03	22643-PY4-003	50118
B24	Friction 45T .079" 5.041" od (125mm) 1st clutch	4	91-03	22544-PY4-003	50125
B26	Steel 20T .079" 3.756" id (95mm) 1st clutch	4	91-03	22543-PY4-003	50119
B23	Friction 45T .093" 5.041" od (125mm) 2nd clutch	4	91-03	22344-PY4-013	50125A
B26	Steel 20T .079" 3.756" id (95mm) 2nd clutch	4	91-03	22543-PY4-003	50119
A21	Friction 45T .093" 5.041" od (125mm) 3rd clutch	4	91-03	22644-PY4-003	50123A
C25	Steel 20T .102" 3.756" id (95mm) 3rd clutch	4	91-03	22643-PY4-003	50118
D24	Friction 45T .079" 5.041" od (125mm) low hold clutch	4	91-03	22544-PY4-003	50125
D26	Steel 20T .079" 3.756" id (95mm) low hold clutch	4	91-03	22543-PY4-003	50119
E24	Friction 45T .079" 5.041" od (125mm) reverse clutch	4	91-03	22544-PY4-003	50125
E26	Steel 20T .079" 3.756" id (95mm) reverse clutch	4	91-03	22543-PY4-003	50119
FILTERS					
K9	Kit, filter Duraprene® MPYA	1	91-95	AE	FK50800T
K9	Kit, filter Duraprene® M5HA/M5DA	1	96-03	AE	FK50800TA
F38	Filter B7VA/MPYA/M5HA/M5DA	1	91-95	25420-PY4-000	50800T
BUSHINGS					
K13	Kit, bushing MPYA	1	91-95	AE	K50901D
WASHERS/BEARINGS/RACES/SHIMS					
B47	Bearing, thrust 52x36x2mm mainshaft 1st gear to collar	1	91-03	91023-PS5-003	50501
B52	Bearing, thrust 56x36x2.5mm mainshaft 2nd gear to collar	1	91-03	91023-PG4-013	50501A
ELECTRICAL COMPONENTS					
G61	Solenoid, shift MPYA/M5HA/M5DA	1	91-03	28200-PY4-004	5A-719
G63	Solenoid, lock-up MPYA/M5HA/M5DA	1	91-03	28300-PY4-013	5A-720

ILL	DESCRIPTION	QTY	YEAR	REFERENCE #	PART #
SPRAGS					
D54	Sprag, assembly oneway MPYA/M5HA (low)	1	91-96	23425-PY4-003	50508
D54	Sprag, assembly oneway M5DA/M5HA (low)	1	96-03	23425-P5D-003	50510
E56	Sprag, assembly oneway MPYA/M5HA (2nd)	1	91-96	23435-PY4-013	50509
E56	Sprag, assembly oneway M5DA/M5HA (2nd)	1	96-03	23435-P5D-003	50511
NOTES					



Electronic Solutions

TeckPak



**K41954
LATE KM SOLENOID**
Fits: Fits: 98-08 F4A41/42/4B/51, A5HF1, R4A51, R5A51,
V4A51, V5A51, W4A42
All positions except VFS solenoid position in 05 up units



**T41435A
LATE KM VFS SOLENOID**
Fits: 05 up F4A41/42/4B/51, F5A51, A5HF1



**K42854 SW
KM INHIBITOR SWITCH**
Fits: 98-08 F4A41/42/51, R4A51, V4A51, W4A42
Also known as PRNDL or Neutral Safety Switch



**T41436
LATE KM OUTPUT PULSE GENERATOR**
Fits: 98-08 F4A41/42/51, F5A51, V4A51, W4A42



**T41438
LATE KM INPUT PULSE GENERATOR**
Fits: 98-08 F4A41/42/51, F5A51, V4A51, W4A42



**T42436G
EARLY KM PULSE GENERATOR**
Fits: 92-98 F4A23, KM-178



**T42436LB
EARLY KM PULSE GENERATOR**
Fits: 96-02 A4AF1/F2, A4BF1/F2, F4A32



**T42436M
EARLY KM PULSE GENERATOR**
Fits: 95-98 F4A33, W4A33



**T42436P
EARLY KM PULSE GENERATOR**
Fits: 90-98 F4A21/22, KM-175/176/177



**K41954 HE
KM HARNESS**
Fits: 96-04 F4A41/42/51
For Four Speed Units



**K41954 HL
KM HARNESS**
Fits: 00-04 F5A51
For Five Speed Units



**T41446AC
KM HARNESS**
Fits: 05 up F4A41/42/51, F4A4B
For Four Speed Units



**T41446CA
KM HARNESS**
Fits: 05 up F5A51, A5HF1
For Five Speed Units



**41437A
KM TEMPERATURE SENSOR**
Fits: 96-04 F4A41/42/51, 00-04 F5A51



**42437L
KM TEMPERATURE SENSOR**
Fits: 93-02 A4AF1/F2, A4BF2/F3, F4A32



**42437J
KM TEMPERATURE SENSOR**
Fits: 85-98 F4A21/22, KM-175/176



**42437M
KM TEMPERATURE SENSOR**
Fits: 95-98 F4A33, W4A33

Toll Free: 1.800.527.2544 • www.teckpak-fitzall.com

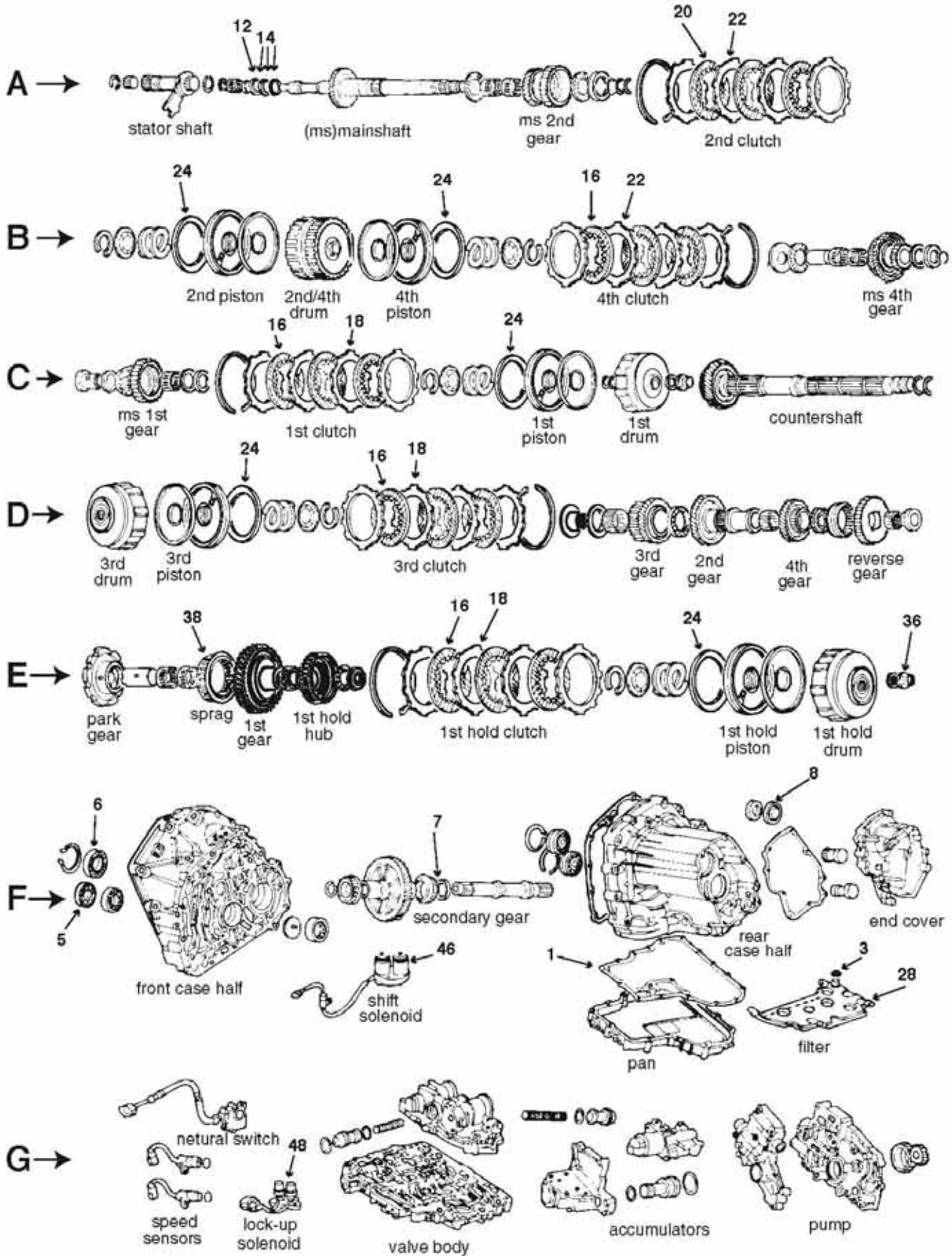

MPWA/M1WA
5000Y

ILL	DESCRIPTION	QTY	YEAR	REFERENCE #	PART #	
TECHNICAL MANUALS						
K53	Tech manual MPWA/M1WA dis/assembly diagnosis/troubleshooting	1	91-98	83-VIGORTM	010-468	
REBUILDER KITS						
K5	Master kit w/steels	MPWA/M1WA	1	91-98	AE	K5000Y
K6	Master kit w/o steels	MPWA/M1WA	1	91-98	AE	K5000Y-LS
K7	O/H gasket set w/seals-rings	MPWA/M1WA	1	91-98	AE	K50900Y
GASKETS AND RUBBER COMPONENTS						
F1	Gasket, oil pan	MPWA/M1WA (Duraprene®)	1	91-98	21813-PW7-000	14029D
F3	O'ring, filter	MPWA/M1WA	1	91-98	91316-PJ7-003	13009
METAL CLAD SEALS						
F5	Seal, metal clad 35x68x5mm	converter (front seal)	1	91-98	91207-P56-003	50201
F6	Seal, metal clad 50x70x11mm	secondary shaft (front)	1	91-98	91201-PW5-015	50223
F7	Seal, metal clad 32x42x7mm	secondary shaft (inner)	1	91-98	91202-PW5-005	50224
F8	Seal, metal clad 40x56x9mm	secondary shaft (rear)	1	91-98	91206-PW5-015	50210
n/i	Seal, metal clad 12x22x7mm	lever shaft	1	91-98	91209-612-003	46202
n/i	Seal, metal clad 9x18x7mm	throttle shaft	1	91-98	91201-PA9-003	50204
n/i	Seal, metal clad 40x60x8mm	left differential (axle)	1	91-98	91205-PW5-005	50225
n/i	Seal, metal clad 52x72x8mm	right differential (axle)		91-98	91203-PW5-025	50226
n/i	Seal, metal clad 52x72x8mm	rear differential (pinion)	1	91-98	91204-PW5-005	50227
SEALING RINGS						
K10	Kit, sealing ring-metal	MPWA/M1WA	1	91-96	AE	K50300E
K10	Kit, sealing ring-teflon	M1WA	1	97-98	AE	K50300H
A12	Ring, sealing-small-metal 29mm	mainshaft	1	91-96	22814-PK4-003	50300E
A12	Ring, sealing-small-teflon 29mm	M1WA (mainshaft)	1	97-98	22815-P4P-003	50306
A14	Ring, sealing-large-metal 35mm	mainshaft	3	91-96	22814-PF4-003	50300D
A14	Ring, sealing-large-teflon 35mm	M1WA (mainshaft)	3	97-98	22814-P4P-003	50307
CLUTCH PLATES						
A20	Friction .075" 4.570" od 41T (116mm)	2nd clutch	4	91-98	22845-PW7-003	50103E
A22	Steel .091" 3.440" id 24T	2nd clutch	4	91-98	22653-PX3-801	50113A
B16	Friction .075" 4.570" od 41T (116mm)	4th clutch	4	91-98	22845-PW7-003	50103E
B22	Steel .091" 3.440" id 24T	4th clutch	4	91-98	22653-PX3-801	50113A
C16	Friction .075" 4.570" od 41T (116mm)	1st clutch	3	91-98	22845-PW7-003	50103E
C18	Steel .079" 3.438" id 10T	1st clutch	3	91-98	22543-PF4-000	50100E
D16	Friction .075" 4.570" od 41T (116mm)	3rd clutch	3	91-98	22845-PW7-003	50103E
D18	Steel .079" 3.438" id 10T	3rd clutch	3	91-98	22543-PF4-000	50100E
E16	Friction .075" 4.570" od 41T (116mm)	1st hold clutch	3	91-98	22845-PW7-003	50103E
n/i	Steel .083" 3.152" id 10T (os)	1st/3rd/1st hold clutch	sel	91-98	058721-210	50100EX
n/i	Wave spring 1st/2nd/3rd/4th/1st hold	replaces Belleville spring w/116mm	1	91-98	058767-110	50151
FILTERS						
K9	Kit, filter	MPWA/M1WA (Duraprene®)	1	91-98	AE	FK50800Y
F28	Filter, oil screen	MPWA/M1WA	1	91-98	25420-PW4-010	50800Y
BUSHINGS						
K13	Kit, bushing	MPWA	1	91-94	AE	K50901C
HARD PARTS						
E36	Nut	MPWA/M1WA (countershaft)	1	91-98	90203-PX4-010	50338
ELECTRICAL COMPONENTS						
F46	Solenoid, shift	MPWA/M1WA	1	91-98	28200-PW4-043	5A-723
G48	Solenoid, lock-up	MPWA/M1WA	1	91-98	28300-PW7-003	5A-724
n/i	Solenoid, pressure	MPWA/M1WA	1	91-98	28250-PW4-003	5A-725
SPRAGS						
E38	Sprag, assembly one way clutch	MPWA/M1WA	1	91-98	23423-PL5-J00	50507
NOTES						

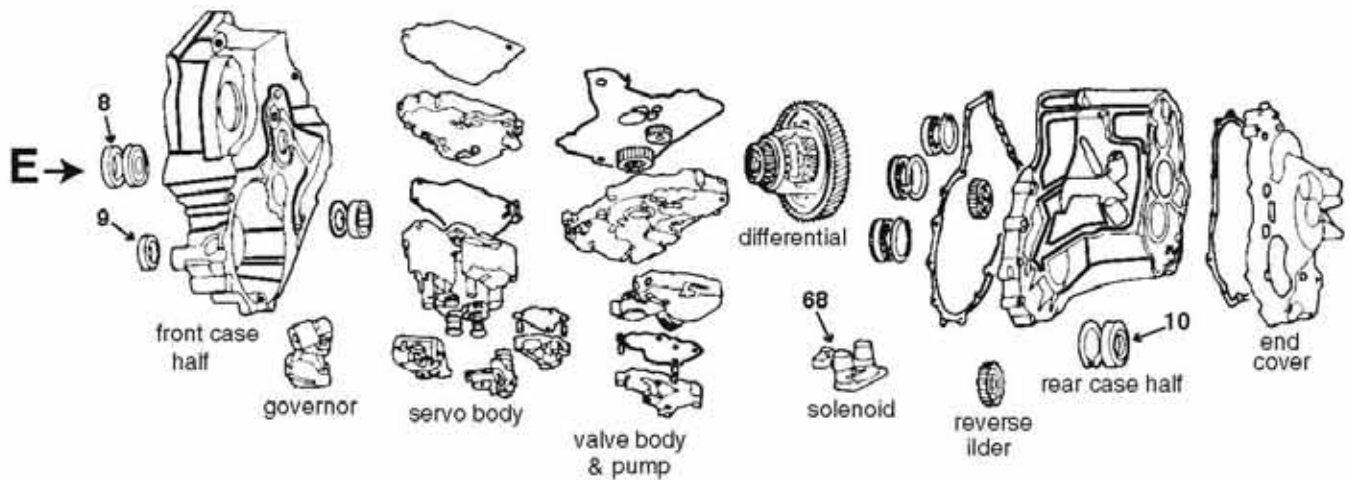
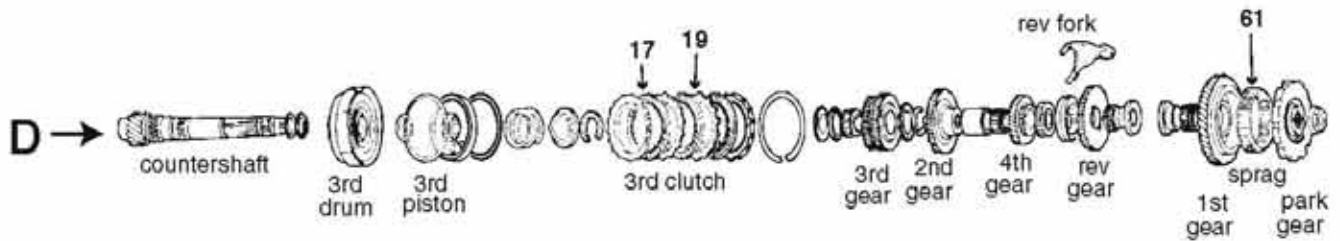
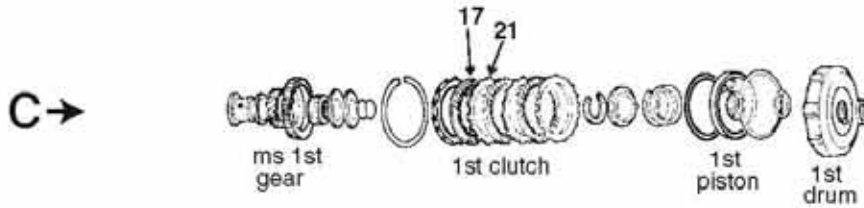
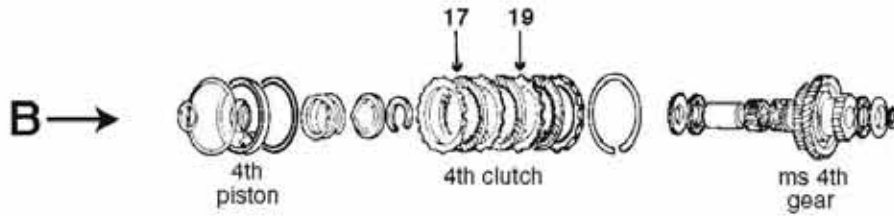
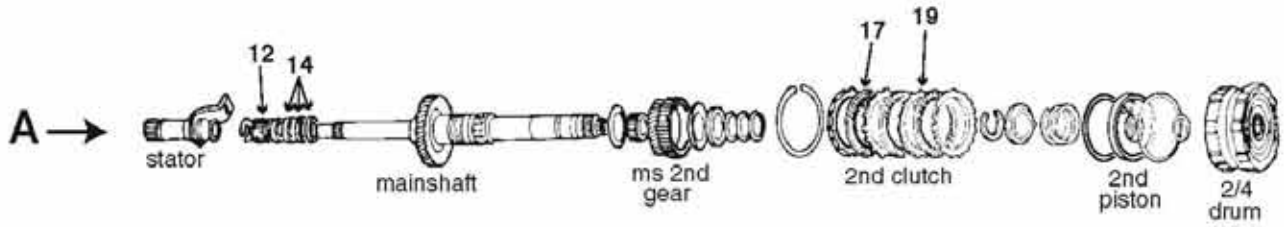

A4RA/B4RA/B46A/M4RA/BMXA/SLXA/BDRA
50000V

ILL	DESCRIPTION		QTY	YEAR	REFERENCE #	PART #
REBUILDER KITS						
K5	Master kit w/steels	all	1	96-06	AE	K5000V
K6	Master kit w/o steels	all	1	96-06	AE	K5000V-LS
K7	O/H gasket set w/seals-rings	all	1	96-06	AE	K50900V
GASKETS AND RUBBER COMPONENTS						
n/i	Seal, oil filter	all	1	96-06	21113-P56-003	13929
METAL CLAD SEALS						
E8	Seal, metal clad 35x68x5mm	all converter (front seal)	1	96-06	91207-POX-003	50201
E9	Seal, metal clad 35x56x8mm	all axle/bell housing	1	96-06	91205-PL3-A01	50211
E10	Seal, metal clad 35x76x9mm	all axle case	1	96-06	91206-689-005	50205
n/i	Seal, metal clad 12x22x7mm	all manual lever shaft	1	96-06	91209-612-003	46202
n/i	Seal, metal clad 9x18x7mm	all trottle valve shaft (TV lever shaft)	1	96-06	91201-PA9-003	50204
SEALING RINGS						
K10	Kit, sealing ring-teflon	all	1	96-06	AE	K50300H
A12	Ring, sealing-small-teflon 29mm	all mainshaft	1	96-06	22815-P4P-003	50306
A14	Ring, sealing-large-teflon 35mm	all mainshaft	3	96-06	22814-P4P-003	50307
CLUTCH PLATES						
A17	Friction .075" 4.323" od 38T (110mm)	2nd clutch	3	96-06	22544-P24-A01	50103D
A19	Steel .079" 3.230" id 8T (80mm)	2nd clutch	3	96-06	22543-PC9-000	50100D
B17	Friction .075" 4.323" od 38T (110mm)	4th clutch	3	96-06	22544-P24-A01	50103D
B19	Steel .079" 3.230" id 8T (80mm)	4th clutch	3	96-06	22543-PC9-000	50100D
C17	Friction .075" 4.323" od 38T (110mm)	1st clutch	3	96-06	22544-P24-A01	50103D
C21	Steel .079" 3.230" id 8T (80mm)	1st clutch	3	96-06	22543-PC9-000	50100D
D17	Friction .075" 4.323" od 38T (110mm)	3rd clutch	3	96-06	22544-P24-A01	50103D
D19	Steel .079" 3.230" id 8T (80mm)	3rd clutch	12	96-06	22543-PC9-000	50100D
FILTERS						
n/i	Filter, oil screen (disassembly required)	all	1	96-98	25420-P56-003	50800A
n/i	Filter, oil	all	1	99-03	25420-P4R-013	50800B
n/i	Filter, oil	all	1	04-06	SPX-F-537	50800V
BUSHINGS						
K13	Kit, bushing	all	1	96-06	AE	K50901
ELECTRICAL COMPONENTS						
E68	Solenoid, lock-up	all	1	96-06	28300-P24-J01	5A-718
n/i	Solenoid, shift	all	1	96-06	28200-P4R-003	5A-741
n/i	Solenoid, linear	all	1	96-06	28250-P4R-315	5A-742
SPRAGS						
D61	Sprag assembly, one way clutch	all	1	96-06	23423-P4R-004	50515
NOTES						

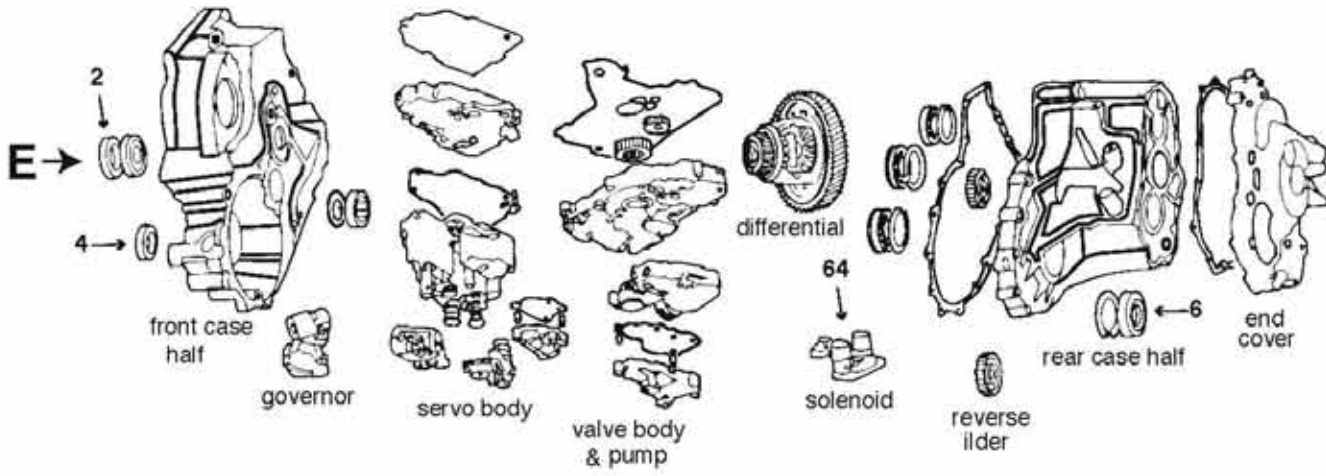
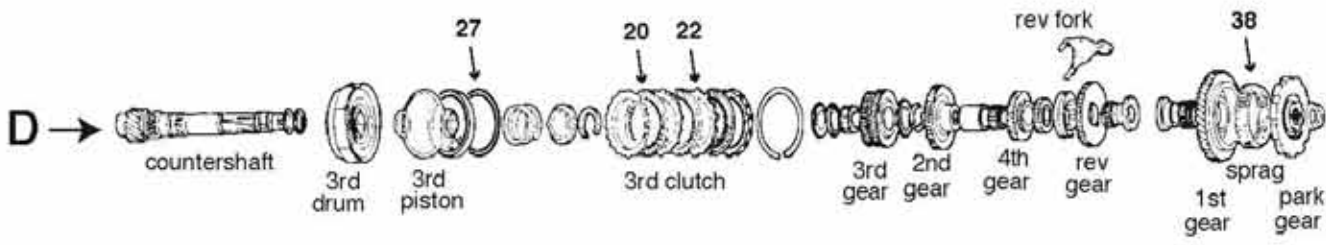
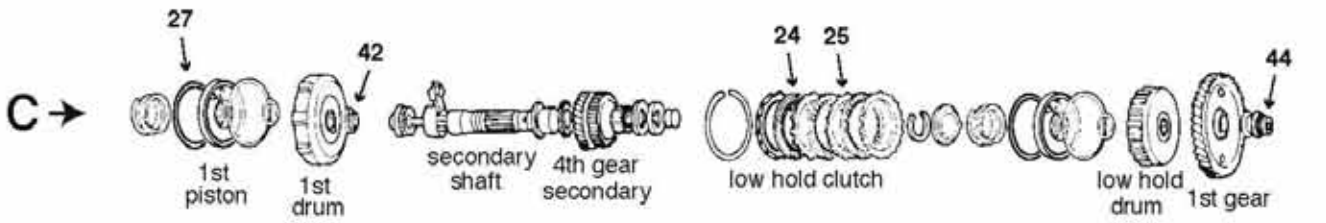
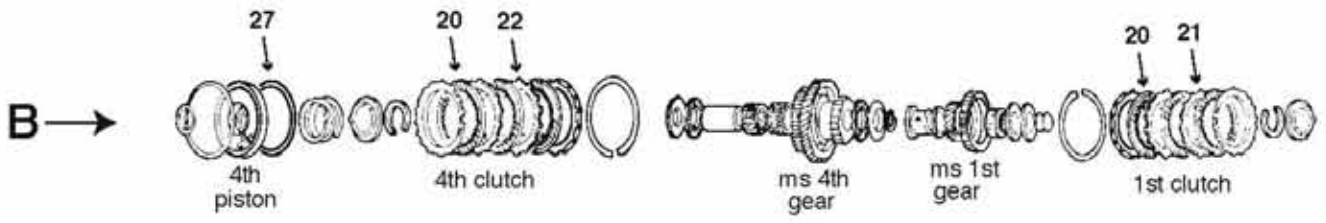

MDLA/A2YA/A24A/M24A/S24A/M4TA/MDMA
50000W/X

ILL	DESCRIPTION	QTY	YEAR	REFERENCE #	PART #
TECHNICAL MANUALS					
K53	Tech manual M24A3 shaft dis/assembly diagnosis/troubleshooting	1	92-95	83-CIV35FTTM	010-455
REBUILDER KITS					
K5	Master kit w/steels Civic/Del Sol (A2YA/A24A/M24A/S24A)	1	92-97	AE	K5000W
K5	Master kit w/steels CRV (M4TA/MDLA/MDMA)	1	97-04	AE	K5000X
K6	Master kit w/o steels Civic/Del Sol (A2YA/A24A/M24A/S24A)	1	92-97	AE	K5000W-LS
K6	Master kit w/o steels CRV (M4TA/MDLA/MDMA)	1	97-04	AE	K5000X-LS
K7	O/H gasket set w/seals-rings Civic/Del Sol (A2YA/A24A/M24A/S24A)	1	92-97	AE	K50900W
K7	O/H gasket set w/seals-rings CRV (M4TA/MDLA/MDMA)	1	97-04	AE	K50900X
GASKETS AND RUBBER COMPONENTS					
n/i	Seal, oil filter M4TA/MDMA/MRVA	1	97-04	21113-P56-003	13929
METAL CLAD SEALS					
E2	Seal, metal clad 35x68x5mm converter (front seal)	1	92-04	91207-POX-003	50201
E4	Seal, metal clad 35x56x8mm axle bell housing	1	92-04	91205-PL3-A01	50211
E6	Seal, metal clad 35x76x9mm axle case (except below)	1	92-04	91206-689-005	50205
E6	Seal, metal clad 40x76x9mm M4TA/MDLA/MDMA (axle case)	1	97-04	91206-PL8-005	50209
n/i	Seal, metal clad 12x22x7mm manual lever shaft	1	92-04	91209-612-003	46202
n/i	Seal, metal clad 9x18x7mm throttle valve shaft (TV lever shaft)	1	92-04	91201-PA9-003	50204
SEALING RINGS					
K10	Kit, sealing ring-metal A24A/A2YA/M24A/S24A	1	92-97	AE	K50300E
K10	Kit, sealing ring-teflon M4TA/MDMA/MRVA	1	96-04	AE	K50300H
A12	Ring, sealing-small-metal 29mm A24A/A2YA/M24A/S24A (mainshaft)	1	92-97	22814-PK4-003	50300E
A12	Ring, sealing-small-teflon 29mm M4TA/MDMA/MRVA (mainshaft)	1	96-04	22815-P4P-003	50306
A14	Ring, sealing-large-metal 35mm A24A/A2YA/M24A/S24A (mainshaft)	3	92-97	22814-PF4-003	50300D
A14	Ring, sealing-large-teflon 35mm M4TA/MDMA/MRVA (mainshaft)	3	96-04	22814-P4P-003	50307
CLUTCH PLATES					
A20	Friction .075" 4.323" od 38T (110mm) A2YA/A24A/M24A (2nd clutch)	3	92-97	22544-P24-A01	50103D
A20	Friction .075" 116mm od 38T M4TA/MDLA/MDMA (2nd clutch)	3	97-04	22544-PDM-003	50120
A22	Steel .079" 3.230" id 8T (80mm) A2YA/A24A/M24A (2nd clutch)	3	92-97	22543-PC9-000	50100D
A22	Steel .079" 82mm id 10T M4TA/MDLA/MDMA (2nd clutch)	3	97-04	22543-P56-N00	50115
B20	Friction .075" 4.323" od 38T (110mm) A2YA/A24A/M24A (4th clutch)	3	92-97	22544-P24-A01	50103D
B20	Friction .075" 116mm od 38T M4TA/MDLA/MDMA (4th clutch)	3	97-04	22544-PDM-003	50120
B22	Steel .079" 3.230" id 8T (80mm) A2YA/A24A/M24A (4th clutch)	3	92-97	22543-PC9-000	50100D
B22	Steel .079" 82mm id 10T M4TA/MDLA/MDMA (4th clutch)	3	97-04	22543-P56-N00	50115
B20	Friction .075" 4.323" od 38T (110mm) A2YA/A24A/M24A (1st clutch)	3	92-97	22544-P24-A01	50103D
B20	Friction .075" 116mm od 38T M4TA/MDLA/MDMA (1st clutch)	3	97-04	22644-P4X-003	50121
B21	Steel .079" 3.230" id 8T (80mm) A2YA/A24A/M24A (1st clutch)	3	92-97	22543-PC9-000	50100D
B21	Steel .063" 82mm id 10T M4TA/MDLA/MDMA (1st clutch)	3	97-04	22543-P4X-000	50115A
C24	Friction .079" 3.940" od 38T A2YA/A24A/M24A (low hold clutch)	3	92-97	22544-P24-S00	50109
C24	Friction .079" 3.940" od 38T M4TA/MDLA/MDMA (low hold clutch)	3	97-04	22544-P24-G00	50109
C25	Steel .079" 2.797" id 18T A2YA/A24A/M24A (low hold clutch)	3	92-97	22543-PS5-003	50116
C25	Steel .063" 71mm id 18T M4TA/MDLA/MDMA (low hold clutch)	3	97-04	22543-PS5-013	50117
D20	Friction .075" 4.323" od 38T (110mm) A2YA/A24A/M24A (3rd clutch)	3	92-97	22544-P24-A01	50103D
D20	Friction .075" 116mm od 38T M4TA/MDLA/MDMA (3rd clutch)	3	97-04	22544-PDM-003	50120
D22	Steel .079" 3.230" id 8T (80mm) A2YA/A24A/M24A (3rd clutch)	3	92-97	22543-PC9-000	50100D
D22	Steel .079" 82mm id 10T M4TA/MDLA/MDMA (3rd clutch)	3	97-04	22543-P56-N00	50115
n/i	Steel .079" 3.152" id 8T (os) (80mm) A2YA/A24A/M24A	sel	92-97	058711-210	50100DX
n/i	Steel .066" 3.152" id 8T (us) (80mm) A2YA/A24A/M24A	sel	92-97	058711A	50106
n/i	Wave spring 1st/2nd/3rd/4th replaces belleville spring w/110mm	1	92-97	058767-110	50150
FILTERS					
n/i	Filter, oil sreen (disassembly required) A24A/A2YA/M24A/S24A	1	92-97	25420-P24-J01	50800X
n/i	Filter, oil screen (disassembly required) M4TA/MDMA/MDLA	1	97-04	25420-P56-003	50800A
n/i	Filter, oil screen MRVA/MCVA/CRV	1	02-06	25420-PRP-003	25175-45004
n/i	Filter, oil MDLA/MDMA/B4RA/S4RA	1	99-01	25420-P4R-003	50800B

LOCTITE®

TRANSMISSION APPLICATIONS

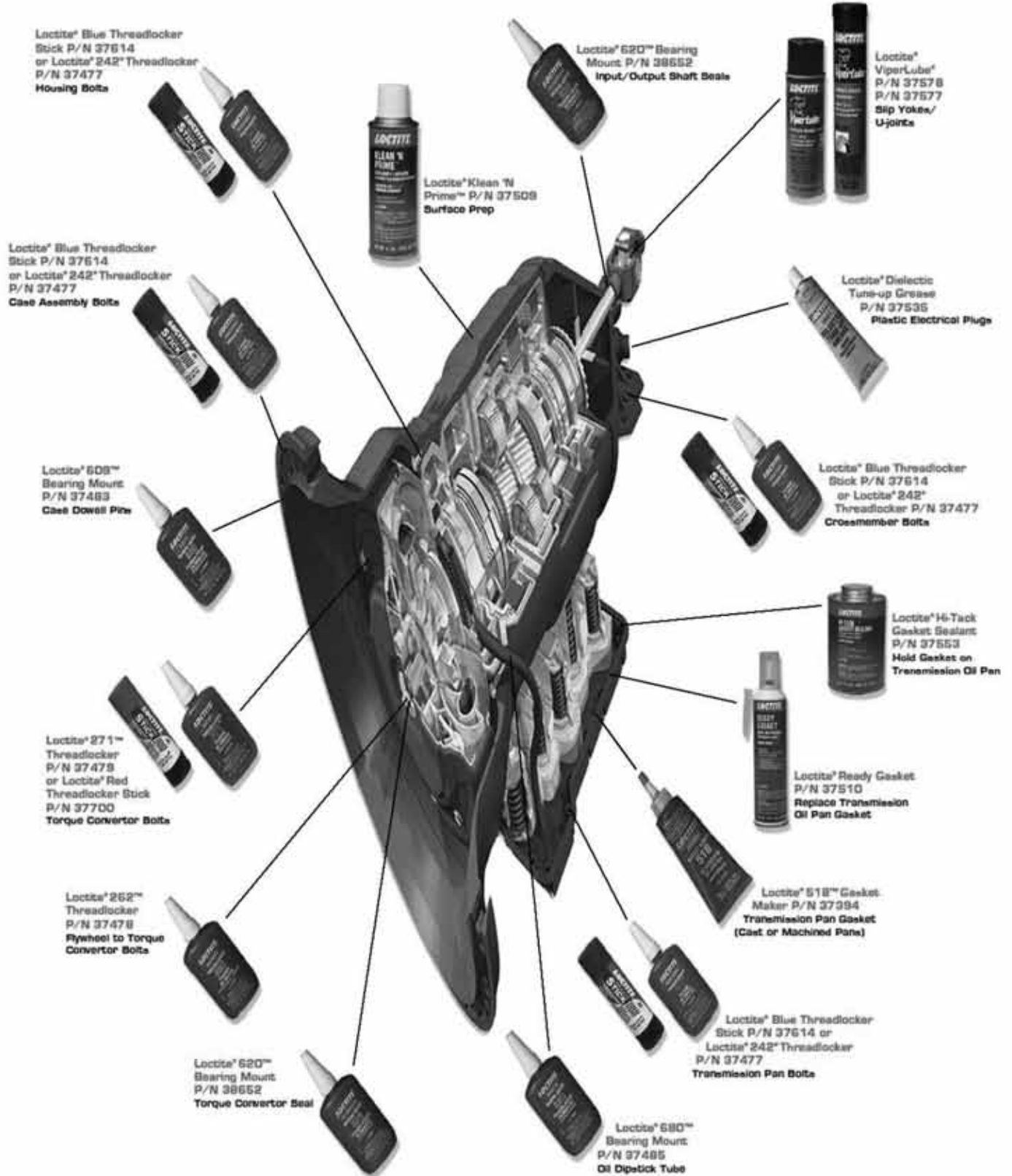

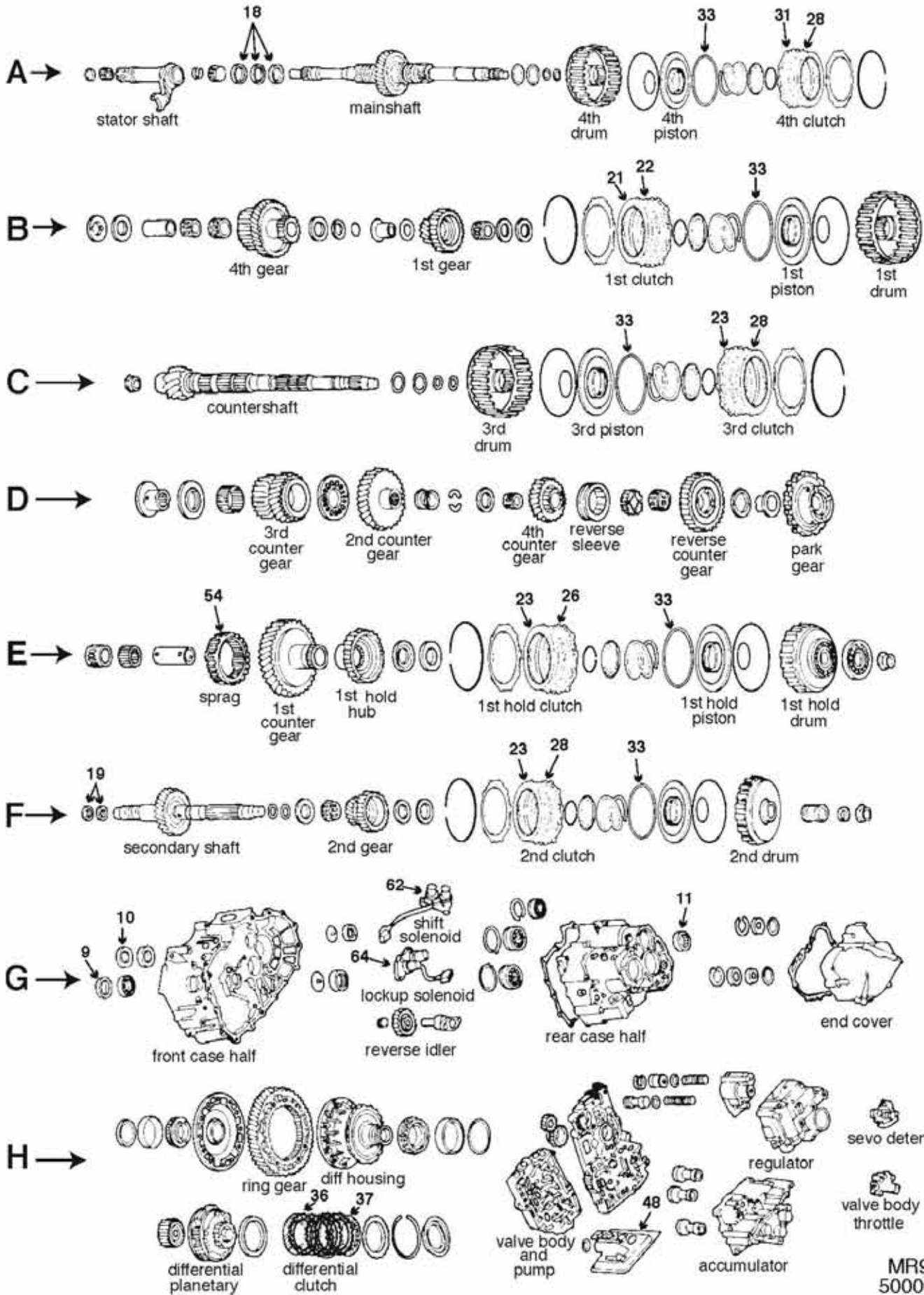

MR9A 50000U

ILL	DESCRIPTION	QTY	YEAR	REFERENCE #	PART #
REBUILDER KITS					
K5	Master kit w/steels MR9A (w/o differential clutches)	1	91-05	AE	K5000U
K6	Master kit w/o steels MR9A (w/o differential clutches)	1	91-05	AE	K5000U-LS
K7	O/H gasket set w/seals-rings MR9A	1	91-05	AE	K50900P
METAL CLAD SEALS					
G9	Seal, metal clad 46x70x8mm converter housing (front seal)	1	91-06	91207-PR9-003	50201B
G10	Seal, metal clad 40x68x12mm bell housing (axle)	1	91-06	91206-PR8-005	50221
G11	Seal, metal clad 42x63x12mm main case (axle)	1	91-06	91207-PR8-005	50222
n/i	Seal, metal clad 12x22x7mm lever seal	1	91-06	91209-612-003	46202
n/i	Seal, metal clad 9x18x7mm TV shaft seal	1	91-06	91201-PA9-003	50204
SEALING RINGS					
K10	Kit, sealing ring MR9A	1	91-05	AE	K50300K
A18	Ring, sealing metal 37mm mainsahft	3	91-05	22814-PR9-003	50302
F19	Ring, sealing-large-metal 35mm secondary shaft	2	91-05	22814-PF4-003	50300D
CLUTCH PLATES					
A31	Friction 0.091" 4.728" od 44T 4th clutch	5	91-05	22674-PR9-003	50127
A28	Steel .091" 3.664" id 24T 4th clutch	5	91-05	22653-PX4-003	50114
B21	Friction .075" 4.570" od 41T (116mm) 1st clutch	5	91-05	22545-PX4-003	50103E
B22	Steel .079" 87mm id 24T 1st clutch	5	91-05	22643-PR0-003	50113
C23	Friction .076" 4.728" od 44T 3rd clutch	5	91-05	22545-PX4-A03	50105
C28	Steel .091" 3.664" id 24T 3rd clutch	5	91-05	22653-PX4-003	50114
E23	Friction .076" 4.728" od 44T 1st hold clutch	3	91-05	22545-PX4-A03	50105
E26	Steel .079" 3.664" id 24T 1st hold clutch	3	91-05	22543-PX4-003	50110
F23	Friction .076" 4.728" od 44T 2nd clutch	5	91-05	22545-PX4-A03	50105
F28	Steel .091" 3.664" id 24T 2nd clutch	5	91-05	22653-PX4-003	50114
n/i	Steel .083" id 24T (os) 1st hold clutch	sel	91-05	078701-210	50110X
n/i	Wave spring 1st/2nd/3rd/4th/1st hold replaces belleville spring w/116/120mm	1	91-05	058767-116	50151
H36	Friction 0.68" 3.940" od 17T (not in kit) differential manual and automatic trans.	7	91-05	41252-PR8-000	50129
H37	Steel .100" 2.758" id 26T (not in kits) differential manual and automatic trans.	6	91-05	41251-PR8-000	50128
FILTERS					
H48	Filter, oil screen MR9A (disassembly required)	1	91-92	25420-PR9-010	50800U
H48	Filter, oil screen MR9A (disassembly required)	1	93-05	25420-PR9-020	50800UA
ELECTRICAL COMPONENTS					
G62	Solenoid, shift MR9A	1	91-98	28200-PR9-004	5A-721
G64	Solenoid, lock-up MR9A	1	90-98	28300-PR9-004	5A-722
SPRAGS					
E54	Sprag assembly, one way MR9A	1	91-98	23423-PR9-003	50512
NOTES					

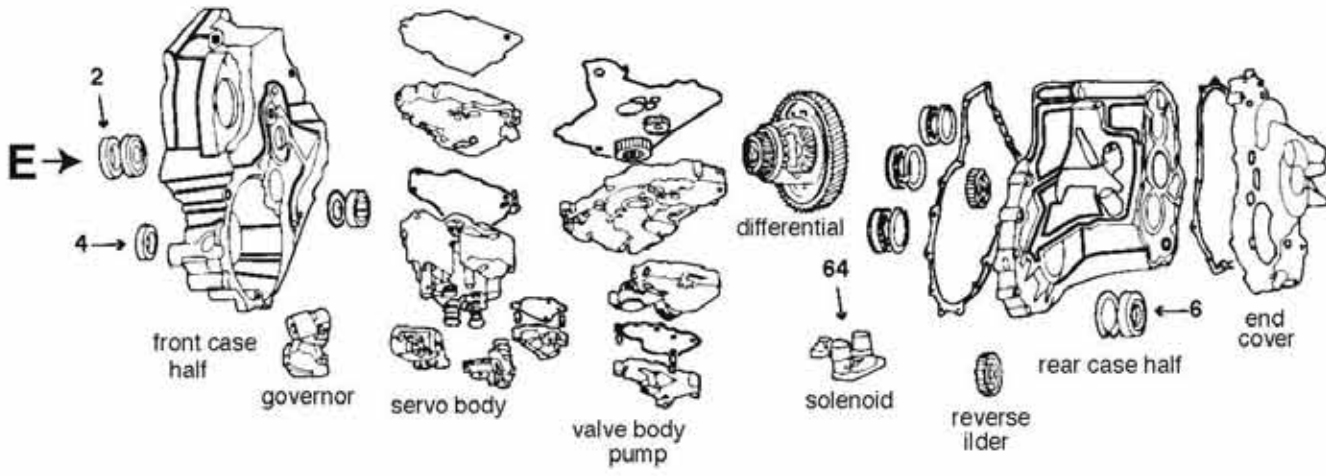
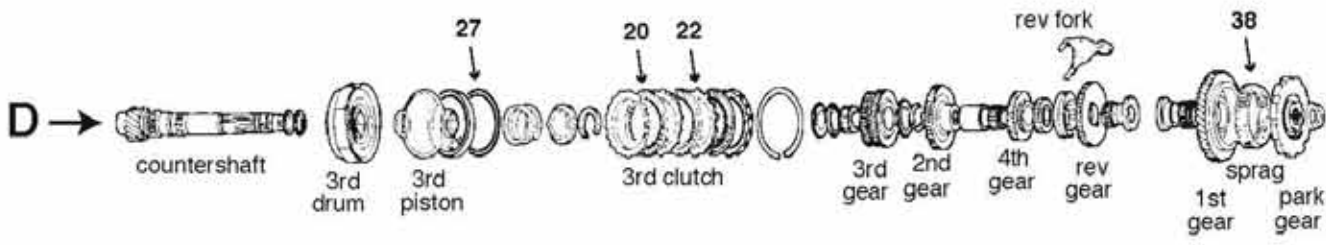
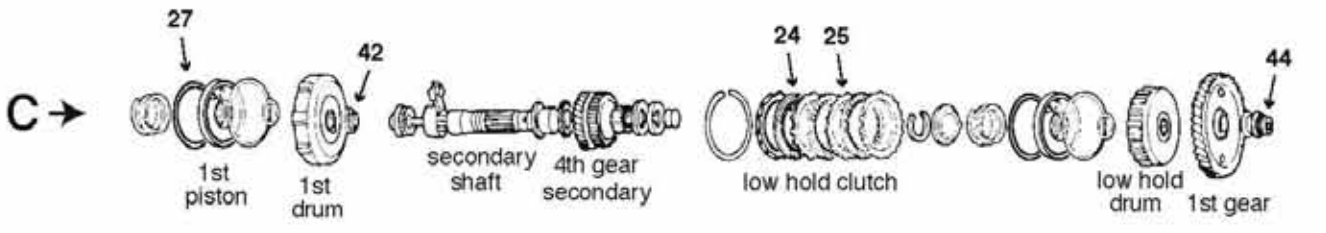
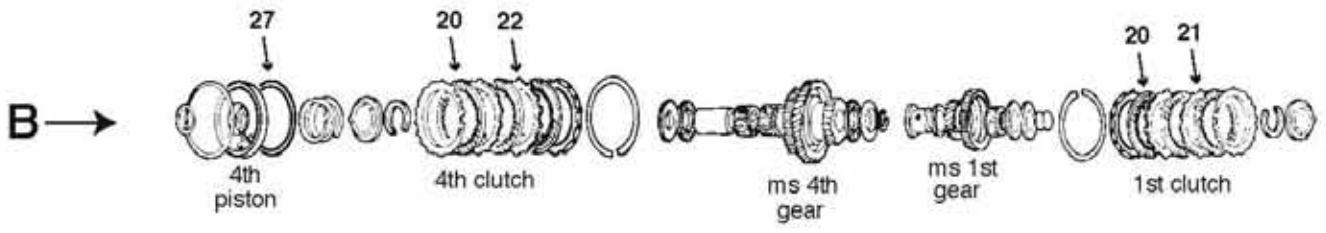

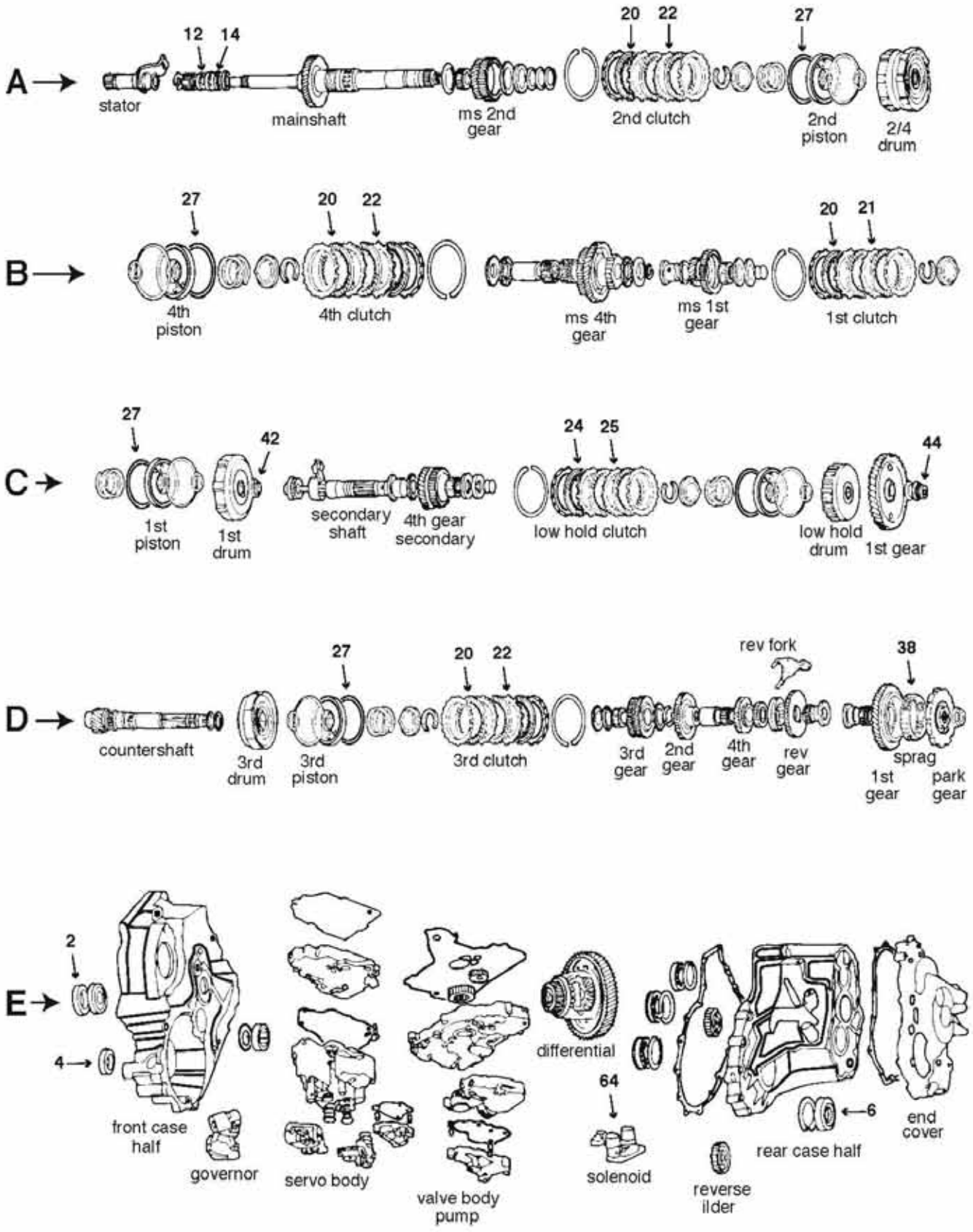

MCVA/MRVA/BZKA
60184-

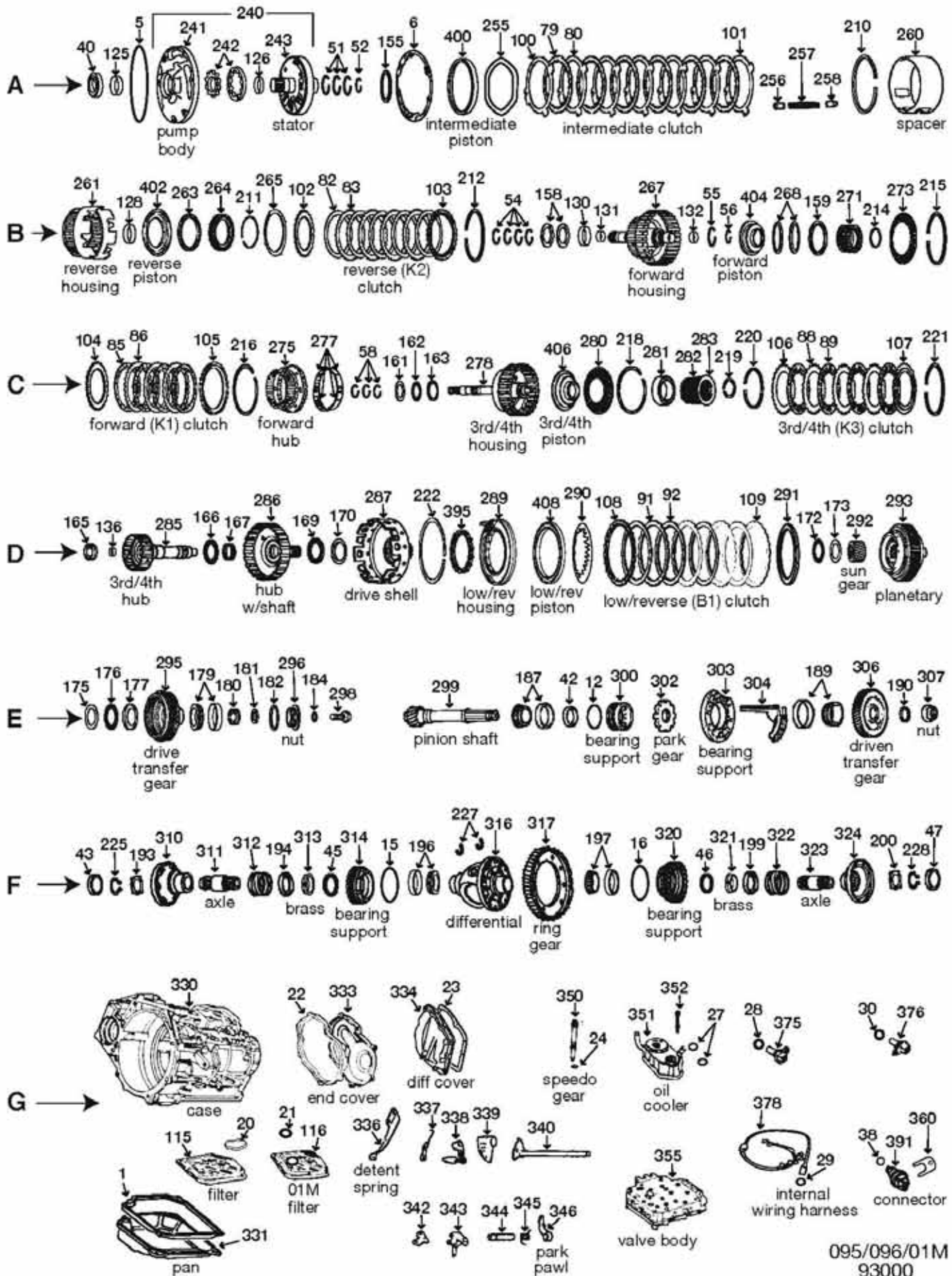

095/096/01M
93000

ILL	DESCRIPTION		QTY	YEAR	REFERENCE #	PART #
TECHNICAL MANUALS						
K53	Tech manual 096/097 dis/assembly	diagnosis/troubleshooting	1	89-10	83-PASSATM	010-461
K53	Tech manual 01M	diagnosis guide	1	89-10	01M-TDG	010-473
REBUILDER KITS						
K5	Master kit w/steels	095/096 (w/pistons)	1	89-94	AE	K9300
K5	Master kit w/steels	096/01M (w/pistons)	1	95-10	AE	K9300A
K5	Master kit w/steels	096 VR-6 only (w/pistons) (1-sided K-3)	1	00-03	AE	K9300B
K6	Master kit w/o steels	095/096 (w/pistons)	1	89-94	AE	K9300-LS
K6	Master kit w/o steels	096/01M (w/pistons)	1	95-10	AE	K9300A-LS
K6	Master kit w/o steels	096 VR-6 only (w/pistons) (1-sided K-3)	1	00-03	AE	K9300B-LS
K7	O/H gasket set w/seals-rings	095/096/01M (w/o pistons)	1	89-10	AE	K93900
n/i	Kit, bonded piston	VW096/01M	1	89-94	AE	K93501
n/i	Kit, bonded piston	VW096/01M	1	95-10	AE	K93502
VALVE BODY KITS						
n/i	Shift Kit® 01M	Corrects lockup,1-2,2-3 problems	1	89-10	SKVW-01M	K93908
GASKETS AND RUBBER COMPONENTS						
G1	Gasket, oil pan (molded rubber)	095/096/01M	1	89-10	096-321-370	13416R
A5	O'ring	pump	1	89-94	095-321-386	13882
A6	Gasket, w/o lock-up	pump to case	1	89-94	095-321-385-A	13883
A6	Gasket, w/lock-up	pump to case	1	95-10	01M-321-385	13884
G22	Gasket, side cover (molded rubber)	095/096/01M	1	89-10	096-321-488	13418R
G23	Gasket	differential cover	1	89-10	095-409-597-A	13885
G29	O'ring	electrical connector	1	89-10	095-325-381-A	13886
n/i	Gasket	solenoid to valve body	7	89-10	n/a	13890
n/i	O'ring	filler tube	1	89-10	003-321-419-A	13887
n/i	O'ring	input shaft	1	89-10	01M-323-255	13888
METAL CLAD SEALS						
A40	Seal, metal clad	front	1	89-10	095-321-243-D	93200
E43	Seal, metal clad	pinion shaft (095)	1	89-91	095-323-862-A	93205
F14	Seal, metal clad	pinion shaft (096/01M0)	1	91-10	096-323-862	93206
F45	Seal, metal clad axle shaft	right axle	1	91-06	020-301-189-H	40204A
F46	Seal, metal clad axle shaft	left axle	1	89-10	020-301-189-H	40204A
F43	Seal, axle spine cap	right axle	1	89-10	020-409-289-B	93210
F47	Seal, axle spine cap	left axle	1	89-10	020-409-289-B	93210
n/i	Seal, metal clad	shift shaft	1	89-10	095-321-182-B	93209
SEALING RINGS						
K10	Kit, sealing ring	VW096/01M	1	89-10	AE	K93300
A51	Sealing ring	pump stator	3	89-10	n/a	93302
A52	Sealing ring	pump stator	1	89-10	n/a	93303
B54	Sealing ring	forward housing	4	89-10	n/a	93305
B55	Sealing ring	forward housing	1	89-10	n/a	93306
B56	Sealing ring	forward housing	1	89-10	n/a	93307
C58	Sealing ring	3/4 housing	3	89-10	n/a	93308
CLUTCH PLATES						
A79	Friction .063" 6.096" od 32T	intermediate clutch (B-2)	4/6	89-10	095-323-465-D	93105
A80	Steel .079" 5.361" id 3T	intermediate clutch (B-2)	5/7	89-10	097-323-463-A	93106
B82	Steel .079" 4.095" id 32T	reverse clutch (K-2)	4/5	89-10	109701	93104
B83	Friction .063" 4.800" od 24T	reverse clutch (K-2)	4/5	89-10	095-323-241-A	93101
C85	Friction .063" 4.800" od 24T	forward clutch (K-1)	4/5	89-10	095-323-241-A	93101
C86	Steel .079" 4.095" id 32T	forward clutch (K-1)	4/5	89-94	109701	93104
C86	Steel .057" 4.095" id 32T	forward clutch (K-1)	4/5	95-10	109701-145	93104A
C88	Steel .079" 2.835" id 26T	3/4 clutch (K-3)	3/5	89-94	109707	93108
C88	Steel .059" 2.835" id 28T	3/4 clutch (K-3)	3/4	95-10	109717-145	93108A
C88	Friction .049" 2.839" id 22T (external T)	3/4 clutch (K-3)(V6 turbo only)1-sided	7	00-03	109716-120	93107B

ILL	DESCRIPTION		QTY	YEAR	REFERENCE #	PART #
CLUTCH PLATES (CONTINUED)						
C89	Friction .048" 4.057" od 28T (internal T)	3/4 clutch (K-3)(V6 turbo only))1-sided)	7	00-03	109717-120	93107C
C89	Friction .063" 3.771" od 22T	3/4 clutch (K-3)	4/6	89-94	095-323-941-A	93107
C89	Friction .063" 4.057" od 22T	3/4 clutch (K-3)	3/4	95-10	095-323-941-C	93107A
D91	Steel .079" 5.078" id 12T	low/reverse clutch (B-1)	6	89-94	095-323-227	93110
D91	Steel .057" 5.078" id 12T	low/reverse clutch (B-1)	6	95-10	095-323-227-A	93110A
D92	Friction .063" 5.743" od 50T (smooth)	low/reverse clutch (B-1)	4/6	89-94	095-323-231-A	93103
D92	Friction .063" 5.743" od 50T (groved)	low/reverse clutch (B-1)	4/6	95-10	095-323-231-C	93103A
PRESSURE PLATES						
A100	Pressure plate (apply)	intermediate clutch (B-2)	1	89-10	AE	93713-R
A101	Pressure plate .089" 3T	intermediate clutch (B-2)	sel	89-10	097-323-463-A	93106A
A101	Pressure plate .095" 3T	intermediate clutch (B-2)	sel	89-10	097-323-463-B	93106B
A101	Pressure plate .108" 3T	intermediate clutch (B-2)	sel	89-10	097-323-463-G	93106C
A101	Pressure plate .118" 3T	intermediate clutch (B-2)	sel	89-10	097-023-463-C	93106D
A101	Pressure plate .128" 3T	intermediate clutch (B-2)	sel	89-10	097-323-463-D	93106E
A101	Pressure plate .138" 3T	intermediate clutch (B-2)	sel	89-10	097-323-463-E	93106F
A101	Pressure plate .148" 3T	intermediate clutch (B-2)	sel	89-10	097-323-463-F	93106G
B102	Pressure plate (apply)	reverse clutch (K2)	1	89-10	AE	93722-R
B103	Pressure plate .200" flat	reverse clutch (K2)	sel	89-94	AE	93714-R
B103	Pressure plate .250" flat	reverse clutch (K2)	sel	89-10	AE	93714A-R
C104	Pressure plate (beveled) (apply)	forward clutch (K-1)	1	89-10	AE	93716-R
C105	Pressure plate .185" flat	forward clutch (K-1)	1	89-10	AE	93715-R
C106	Pressure plate .210" flat (apply)	3/4 clutch (K3)	1	89-10	AE	93717-R
C107	Pressure plate (stepped)	3/4 clutch (K3)	sel	89-10	AE	93718-R
C107	Pressure plate .215" (stepped)	3/4 clutch (K3)	sel	89-10	AE	93719-R
C107	Pressure plate .235" (stepped)	3/4 clutch (K3)	sel	89-10	AE	93720-R
C107	Pressure plate w/friction lining (stepped)	3/4 clutch (K3) (VR-6 only)	1	00-03	AE	93725
D108	Pressure plate .285" (beveled) (apply)	low/reverse clutch (B1)	sel	89-10	095-323-297-A	93721-R
D108	Pressure plate .405" (beveled) (apply)	low/reverse clutch (B1)	sel	89-10	095-323-297-B	93721A-R
D109	Pressure plate .525" flat	low/reverse clutch (B1)	1	89-10	AE	93721B-R
FILTERS						
K9	Kit, filter	095/096	1	89-95	AE	FK93800
K9	Kit, filter	096/01M	1	96-10	AE	FK93800A
G115	Filter, oil	095/096	1	89-95	095-325-429-C	93800
G116	Filter, oil	096/01M	1	96-10	01M-325-429	93800A
BUSHINGS						
K13	Kit, bushing	VW096/01M	1	89-10	AE	K93901
A125	Bushing	VW096/01M (pump body)	1	89-10	n/a	93005
A126	Bushing	pump stator (front)	1	89-10	n/a	93007
B128	Bushing	reverse housing (front)	1	89-10	n/a	93009
B130	Bushing	reverse housing (rear)	1	89-10	n/a	93010
B131	Bushing	forward housing (front)	1	89-10	n/a	93011
D136	Bushing	3/4 hub	1	89-10	n/a	93015
WASHERS/BEARINGS/RACES/SHIMS						
A155	Washer, thrust	pump to reverse housing	1	89-10	095-321-285	93401
B158	Washer, thrust	reverse housing to forward housing	sel	89-10	095-323-345	93403
B159	Washer, thrust	input shaft	1	89-94	49596203	93404
C161	Race, thrust	forward housing to 3/4 housing	1	89-10	n/a	93407
C162	Bearing, thrust	forward housing to 3/4 housing	1	89-10	n/a	93408
C163	Race, thrust	forward housing to 3/4 housing	1	89-10	n/a	93409
D165	Bearing, thrust	3/4 hub to 3/4 housing	1	89-10	n/a	93412
D166	Bearing, thrust	drive hub to 3/4 hub	1	89-10	n/a	93414
D167	Bearing, caged	drive hub to 3/4 hub	1	89-10	n/a	93415
D169	Bearing, thrust	drive hub to drive shell	1	89-10	n/a	93418

ILL	DESCRIPTION	QTY	YEAR	REFERENCE #	PART #	
WASHERS/BEARINGS/RACES/SHIMS (CONTINUED)						
D170	Race, thrust	drive hub to drive shell	1	89-10	n/a	93419
D172	Bearing, thrust	sun gear to drive shell	1	89-10	n/a	93421
D173	Race, thrust	sun gear to drive shell	1	89-10	n/a	93422
E175	Race, thrust	planetary to transfer drive gear	1	89-10	n/a	93424
E176	Bearing, thrust	planetary to transfer drive gear	1	89-10	n/a	93425
E177	Race, thrust	planetary to transfer drive gear	1	89-10	n/a	93426
E179	Bearing, cup/cone	transfer drive gear	1	89-10	n/a	93429
E180	Washer, spacer	transfer drive gear	1	89-10	n/a	93430
E181	Washer, spacer	transfer drive gear	1	89-10	n/a	93431
E182	Washer, spacer	transfer drive gear	1	89-10	n/a	93432
E187	Bearing, cup/cone	pinion shaft	1	89-10	n/a	93435
E189	Bearing, cup/cone	driven transfer gear	1	89-10	n/a	93436
E190	Washer, spacer	driven transfer gear	1	89-10	n/a	93438
F193	Washer, thrust	right axle	1	89-10	n/a	93440
F194	Washer, sleeve	right axle	1	89-10	n/a	93442
F196	Bearing, cup/cone	right differential	1	89-10	n/a	93445
F197	Bearing, cup/cone	left differential	1	89-10	n/a	93445
F199	Washer, sleeve	left axle	1	89-10	n/a	93442
SNAP RINGS						
A210	Snap ring	intermediate clutch	1	89-10	AE	93603-R
B211	Snap ring	reverse clutch retainer	1	89-10	AE	93605-R
B212	Snap ring	reverse clutch pressure plate	1	89-10	AE	93608-R
B215	Snap ring	forward clutch retainer	1	89-10	AE	93611-R
C216	Snap ring	forward clutch pressure plate	1	89-10	AE	93614-R
C218	Snap ring	3/4 clutch retainer	1	89-10	AE	93618-R
C219	Snap ring	3/4 clutch retainer	1	89-10	AE	93619-R
C220	Snap ring	3/4 clutch retainer	1	89-10	AE	93620-R
C221	Snap ring	3/4 clutch pressure plate	1	89-10	AE	93623-R
D222	Snap ring	low/reverse housing	1	89-10	AE	93625-R
F225	Snap ring	right axle	1	89-10	AE	93632-R
F228	Snap ring	left axle	1	89-10	AE	93632-R
PUMP PARTS AND PUMPS						
A240	Pump assembly	095/096/01M	1	89-10	AE	93910-R
HARD PARTS						
A255	Plate, cushion waved .055"	intermediate clutch (B-2)	1	89-10	095-323-471	93120
A256	Retainer, intermediate spring	front	3	89-10	AE	93912-R
A257	Spring, intermediate clutch	096-01M	3	89-10	AE	93913-R
A258	Retainer, intermediate spring	rear	3	89-10	AE	93912-R
A260	Spacer, intermediate clutch	096-01M	1	89-10	AE	93914-R
B261	Housing, reverse clutch	096-01M	1	89-10	AE	93915-R
B263	Guide, reverse clutch springs	096-01M	1	89-10	AE	93916-R
B264	Spring, retainer reverse clutch	096-01M	1	89-10	AE	93917-R
B265	Plate, cushion waved .059"	reverse clutch (K-2)	1	89-10	n/a	93121
B267	Housing, forward clutch	096-01M	1	89-10	AE	93918-R
B268	Plate, cushion (forward clutch)	096-01M	2	89-10	AE	93919-R
B271	Retainer, w/springs	forward clutch	1	89-10	Ae	93921-R
B273	Spring, diaphragm	forward clutch (K-1)	1	89-94	AE	93701-R
C275	Hub, forward clutch	096-01M	1	89-10	AE	93923-R
C277	Spacer, forward hub	096-01M	2	89-10	AE	93924-R
C278	Housing, 3/4 clutch	096-01M	1	89-10	AE	93925-R
C280	Spring, diaphragm	3/4 clutch (K-3)	1	89-10	095-323-295-A	93702-R
C281	Guide, spring (3/4 clutch)	096-01M	1	89-10	AE	93927-R
C282	Retainer, w/springs	3/4 clutch	1	89-10	AE	93928-R

AG4•095•096•01M

AG4•095•096•01M

ILL	DESCRIPTION	QTY	YEAR	REFERENCE #	PART #
HARD PARTS (CONTINUED)					
C283	Retainer, w/o springs	3/4 clutch	1	89-10 AE	93929-R
D285	Hub, 3/4 clutch	096-01M	1	89-10 AE	93930-R
D286	Hub, 3/4 drive	096-01M	1	89-10 AE	93931-R
D287	Shell, drive w/sun gear 27T	096-01M	1	89-10 AE	93933-R
D289	Housing, low/reverse clutch	outer low/reverse sprag race	1	89-10 AE	93935-R
D290	Spring, diaphragm	low/reverse clutch (B-1)	1	89-10 095-323-295-A	93703-R
D291	Plate .075" dished	low/reverse clutch (B-1)	1	89-10 n/a	93122
D292	Gear, sun rear 21T	096-01M	1	89-10 AE	93938-R
D293	Planetary, rear	096-01M	1	89-10 AE	93941-R
E295	Gear, rear ring (drive transfer)	096-01M	1	89-10 AE	93943-R
E299	Shaft, pinion	096-01M	1	89-10 AE	93945-R
E300	Support, pinion bearing	096-01M	1	89-10 AE	93948-R
E302	Gear, park	096-01M	1	89-10 AE	93950-R
E303	Support, driven transfer gear	096-01M	1	89-10 AE	93952-R
E306	Gear, driven transfer	096-01M	1	89-10 AE	93955-R
E307	Nut, driven transfer gear	096-01M	1	89-10 AE	93957-R
F311	Shaft, right axle	096-01M	1	89-10 AE	93960-R
F312	Spring, axle load	096-01M	1	89-10 AE	93961-R
F313	Ring, axle shaft clutch (brass)	096-01M	1	89-10 AE	93965-R
F314	Support, right differential bearing	096-01M	1	89-10 AE	93967-R
F316	Differential assembly w/o ring gear	096-01M	1	89-10 AE	93969-R
F317	Gear, ring	096-01M	1	89-10 AE	93970-R
F320	Support, left differential bearing	096-01M	1	89-10 AE	93972-R
F321	Ring, axle shaft clutch (brass)	096-01M	1	89-10 AE	93965-R
G322	Spring, axle load	096-01M	1	89-10 AE	93961-R
G330	Housing, case	096-01M	1	89-10 AE	93975-R
G331	Pan, bottom	096-01M	1	89-10 AE	93978-R
G333	Pan, end cover	096-01M	1	89-10 AE	93979-R
G334	Pan, differential cover	096-01M	1	89-10 AE	93980-R
G344	Pin, park pawl	096-01M	1	98-10 AE	93989-R
G345	Spring, park pawl	096-01M	1	89-10 AE	93990-R
G346	Pawl, park	096-01M	1	89-10 AE	93991-R
G351	Cooler, oil	096-01M	1	89-10 AE	93993-R
G355	Valve body w/solenoids	096-01M	1	89-10 AE	93995-R
ELECTRICAL COMPONENTS					
G378	Harness, internal - heavy duty	096/01M	1	95-10 350-0070	16A-155
n/i	Solenoid	EPC	1	89-10 095-927-333	5A-245
n/i	Solenoid	TCC	1	95-10 095-927-333	5A-245
n/i	Solenoid	Shift	5/6	89-10 095-927-331	5A-246
SPRAGS					
D395	Sprag, low/reverse	095/096/01M	1	89-10 095-323-383	93512
BONDED PISTONS					
A400	Piston, bonded rubber	intermediate clutch (B2)	1	89-10 095-321-531-C	93503
B402	Piston, bonded rubber	reverse clutch (K-2)	1	89-10 095-323-121-E	93504
B404	Piston, bonded rubber	forward clutch (K1)	1	89-94 098-323-217-B	93505
B404	Piston, bonded rubber	forward clutch (K1)	1	95-10 095-323-217-G	93506
B404	Piston, bonded rubber (balance)	forward clutch (K1)	1	95-10 095-323-257	93510
C406	Piston, bonded rubber	3/4 clutch (K3)	1	89-94 095-323-927-A	93507
C406	Piston, bonded rubber	3/4 clutch (K3)	1	95-10 095-323-927-G	93508
C406	Piston, bonded rubber (balance)	3/4 clutch (K3)	1	95-10 095-323-977-C	93511
D408	Piston, bonded rubber	low/reverse clutch (B-1)	1	89-10 095-323-479	93509
n/i	Kit, bonded piston	095/096/01M	1	90-94 AE	K93501
n/i	Kit, bonded piston	095/096/01M	1	95-10 AE	K93502



*Experience isn't just how long
you've been in business. It's what you know.
And these guys know transmissions.*

Having the parts you need is important. Knowing what you need is the difference. Our parts are researched and tested by our quality staff, so you will have the confidence that, when you buy a Toledo Driveline™ part, you get the quality and performance you demand.

But that's not our only strength. Backing up our complete line of parts with over 5 decades of know how and what you need.

So, look to Toledo Driveline™ quality and selection for transmission parts you can trust. And count on the expert knowledge to back them up.

Toledo
DRIVELINE

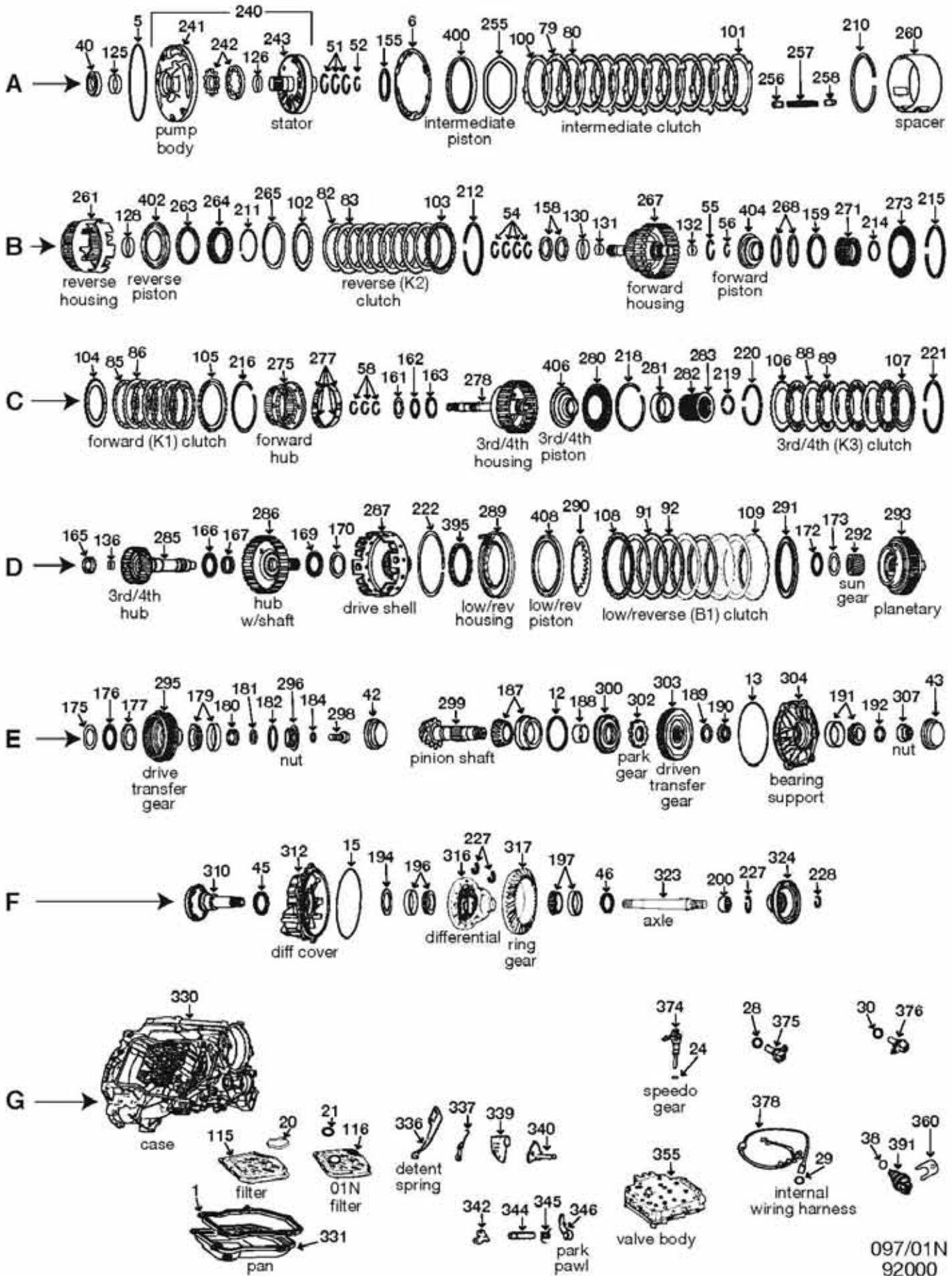

097/01N
92000

ILL	DESCRIPTION	QTY	YEAR	REFERENCE #	PART #
TECHNICAL MANUALS					
K53	Tech manual 096/097 dis/assembly diagnostic & troubleshooting	1	92-98	83-PASSATM	010-461
REBUILDER KITS					
K5	Master kit w/steels w/pistons	1	90-94	AE	K9200
K5	Master kit w/o steels w/pistons	1	95-98	AE	K9200A-LS
K6	Master kit w/o steels, Audi 097 w/pistons	1	90-94	AE	K9200-LS
K6	Master kit w/o steels w/pistons	1	95-98	AE	K9200A-LS
K7	O/H Gasket set w/seals-rings w/o pistons	1	90-98	AE	K92900
n/i	Kit, bonded piston 097/01N	1	90-94	AE	K93501
n/i	Kit, bonded piston 097/01N	1	95-95	AE	K93502
GASKETS AND RUBBER COMPONENTS					
G1	Gasket, oil pan 097	1	90-94	097-321-371	13414R
G1	Gasket, oil pan 01N	1	95-98	01N-321-371	13417R
A5	O'ring pump body	1	90-98	095-321-386	13882
A6	Gasket, w/o lock-up pump to case	1	90-94	095-321-385-A	13883
A6	Gasket, w/lock-up pump to case	1	95-98	01M-321-385	13884
G29	O'ring case connector	1	90-98	095-325-381-A	13886
n/i	O'ring filler tube	1	90-98	003-321-419-A	13887
n/i	O'ring shift shaft	1	90-98	095-323-969	13889
n/i	Gasket solenoid to valve body	7	90-98	n/a	13890
METAL CLAD SEALS					
A40	Seal, metal clad front	1	90-98	095-321-243-D	93200
E43	Seal, metal clad pinion shaft	1	90-98	097-409-529-D	93207
F45	Seal, metal clad left axle	1	90-98	097-409-400-D	93202
F46	Seal, metal clad right axle	1	90-98	097-409-399-A	93203
SEALING RINGS					
K10	Kit, sealing ring 097/01N	1	90-98	AE	K93300
CLUTCH PLATES					
A79	Friction .063" 6.096" od 32T intermediate clutch (B-2)	4/6	90-98	095-323-465-D	93105
A80	Steel .079" 5.361" id 3T intermediate clutch (B-2)	5/7	90-98	097-323-463-A	93106
B82	Steel .079" 4.095" id 32T reverse clutch (K-2)	4/5	90-98	109701	93104
B83	Friction .063" 4.800" od 24T reverse clutch (K-2)	4/5	90-98	095-323-241-A	93101
C85	Friction .063" 4.800" od 24T forward clutch (K-1)	4/5	90-98	095-323-241-A	93101
C86	Steel .079" 4.095" id 32T forward clutch (K-1)	4/5	90-94	109701	93104
C86	Steel .057" 4.095" id 32T forward clutch (K-1)	4/5	95-98	109701-145	93104A
C88	Steel .079" 2.835" id 26T 3/4 clutch (K-3)	3/5	90-94	109707	93108
C88	Steel .059" 2.835" id 28T 3/4 clutch (K-3)	3/4	95-98	109717-145	93108A
C89	Friction .063" 3.771" od 22T 3/4 clutch (K-3)	4/6	90-94	095-323-941-A	93107
C89	Friction .063" 4.057" od 22T 3/4 clutch (K-3)	3/4	95-98	095-323-941-C	93107A
D91	Steel .079" 5.078" id 12T low/reverse clutch (B-1)	6	90-94	095-323-227	93110
D91	Steel .057" 5.078" id 12T low/reverse clutch (B-1)	6	95-98	095-323-227-A	93110A
D92	Friction .063" 5.743" od 50T (smooth) low/reverse clutch (B-1)	4/6	90-94	095-323-231-A	93103
D92	Friction .063" 5.743" od 50T (grooved) low/reverse clutch (B-1)	4/6	95-98	095-323-231-C	93103A
PRESSURE PLATES					
A100	Pressure plate (apply) intermediate clutch (B-2)	1	90-98	AE	93713-R
A101	Pressure plate .089" 3T intermediate clutch (B-2)	sel	90-98	097-323-463-A	93106A
A101	Pressure plate .095" 3T intermediate clutch (B-2)	sel	90-98	097-323-463-B	93106B
A101	Pressure plate .108" 3T intermediate clutch (B-2)	sel	90-98	097-323-463-G	93106C
A101	Pressure plate .118" 3T intermediate clutch (B-2)	sel	90-98	097-023-463-C	93106D
A101	Pressure plate .128" 3T intermediate clutch (B-2)	sel	90-98	097-323-463-D	93106E
A101	Pressure plate .138" 3T intermediate clutch (B-2)	sel	90-98	097-323-463-E	93106F
A101	Pressure plate .148" 3T intermediate clutch (B-2)	sel	90-98	097-323-463-F	93106G
B102	Pressure plate (apply) reverse clutch (K2)	1	90-98	AE	93722-R
B103	Pressure plate .200" flat reverse clutch (K2)	sel	90-98	AE	93714-R

ILL	DESCRIPTION		QTY	YEAR	REFERENCE #	PART #
PRESSURE PLATES (CONTINUED)						
B103	Pressure plate .250" flat	reverse clutch (K2)	sel	90-98	AE	93714A-R
C104	Pressure plate (beveled) (apply)	forward clutch (K-1)	1	90-98	AE	93716-R
C105	Pressure plate .185" flat	forward clutch (K-1)	1	90-98	AE	93715-R
C106	Pressure plate .210" flat (apply)	3/4 clutch (K3)	1	90-98	AE	93717-R
C107	Pressure plate (stepped)	3/4 clutch (K3)	sel	90-98	AE	93718-R
C107	Pressure plate .215" (stepped)	3/4 clutch (K3)	sel	90-98	AE	93719-R
C107	Pressure plate .235" (stepped)	3/4 clutch (K3)	sel	90-98	AE	93720-R
D108	Pressure plate .285" (beveled) (apply)	low/reverse clutch (B1)	sel	90-98	095-323-297-A	93721-R
D108	Pressure plate .405" (beveled) (apply)	low/reverse clutch (B1)	sel	90-98	095-323-297-B	93721A-R
D109	Pressure plate .525" flat	low/reverse clutch (B1)	1	90-98	AE	93721B-R
FILTERS						
K9	Kit, filter	097	1	90-94	AE	FK92800
K9	Kit, filter	01N	1	95-98	AE	FK92800A
G115	Filter, oil	097	1	90-94	095-325-429-C	93800
G116	Filter, oil	01N	1	95-98	01M-325-429	93800A
BUSHINGS						
K12	Kit, bushing	097/01N	1	90-98	AE	K93901
A125	Bushing	pump body	1	90-98	n/a	93005
WASHERS/BEARINGS/RACES/SHIMS						
A155	Washer, thrust	pump to reverse housing	1	90-98	095-321-285	93401
B158	Washer, thrust	reverse housing to forward housing	sel	90-98	095-323-345	93403
B159	Washer, thrust	input shaft	1	90-98	49596203	93404
PUMP PARTS AND PUMPS						
A240	Pump assembly	097/01N	1	90-98	AE	92910-R
HARD PARTS						
A255	Plate, cushion waved .055"	intermediate clutch (B-2)	1	90-98	095-323-471	93120
A265	Plate, cushion waved .059"	reverse clutch (K-2)	1	90-98	n/a	93121
B273	Spring, diaphragm	forward clutch (K-1)	1	90-98	AE	93701-R
C280	Spring, diaphragm	3/4 clutch (K-3)	1	90-98	095-323-295-A	93702-R
D290	Spring, diaphragm	low/reverse clutch (B-1)	1	90-98	095-323-295-A	93703-R
D291	Plate .075" dished	low/reverse clutch (B-1)	1	90-98	n/a	93122
ELECTRICAL COMPONENTS						
n/i	Solenoid	EPC	1	90-98	095-927-333	5A-245
n/i	Solenoid	TCC	1	95-98	095-927-333	5A-245
n/i	Solenoid	shift	5/6	90-98	095-927-331	5A-246
SPRAGS						
D395	Sprag, low/reverse	097/01N	1	90-98	095-323-383	93512
BONDED PISTONS						
A400	Piston, bonded rubber	intermediate clutch (B2)	1	92-98	095-321-531-C	93503
B402	Piston, bonded rubber	reverse clutch (K-2)	1	92-98	095-323-121-E	93504
B404	Piston, bonded rubber	forward clutch (K1)	1	92-94	098-323-217-B	93505
B404	Piston, bonded rubber	forward clutch (K1)	1	95-98	095-323-217-G	93506
B404	Piston, bonded rubber (balance)	forward clutch (K1)	1	95-98	095-323-257	93510
C406	Piston, bonded rubber	3/4 clutch (K3)	1	92-94	095-323-927-A	93507
C406	Piston, bonded rubber	3/4 clutch (K3)	1	95-98	095-323-927-G	93508
C406	Piston, bonded rubber (balance)	3/4 clutch (K3)	1	95-98	095-323-977-C	93511
D408	Piston, bonded rubber	low/reverse clutch (B-1)	1	92-98	095-323-479	93509
n/i	Kit, bonded piston	097/01N	1	92-94	AE	K93501
n/i	Kit, bonded piston	097/01N	1	95-98	AE	K93502
NOTES						



GFX Inc.

“The Monster” is just one of the many parts that GFX has manufactured within the last few years.

We specialize in offering the industry quality hard parts at very competitive prices. We also carry many popular items such as Pump Gears, Solenoids, Borg-Warner Morse chains, Dynax Friction Plates and much more.

305-499-9789-office 305-499-9789-Fax

A & Reds, authorized GFX Distributor

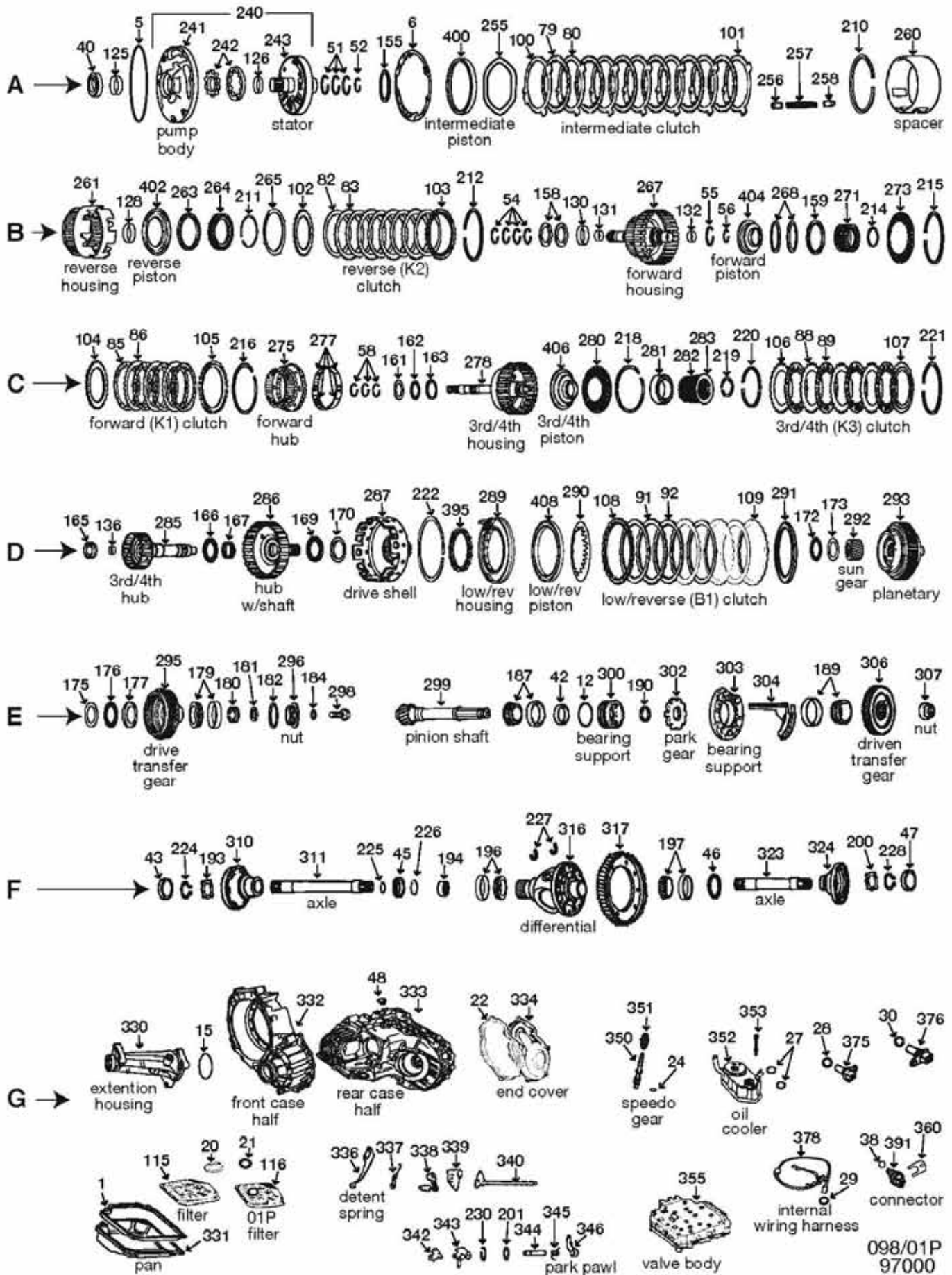

098/01P
97000

ILL	DESCRIPTION	QTY	YEAR	REFERENCE #	PART #
TECHNICAL MANUALS					
K53	Tech manual 096/097 dis/assembly diagnosis & troubleshooting	1	92-03	83-PASSATM	010-461
REBUILDER KITS					
K5	Master kit, w/steels w/pistons	1	92-94	AE	K9700
K5	Master kit, w/steels w/pistons	1	95-03	AE	K9700A
K6	Master kit w/o steels w/pistons	1	92-94	AE	K9700-LS
K6	Master kit, w/o steels w/pistons	1	95-03	AE	K9700A-LS
K7	O/H Gasket set w/seals-rings w/o pistons	1	92-03	AE	K97900
n/i	Kit, bonded piston 098	1	92-94	AE	K93501
n/i	Kit, bonded piston 01P	1	95-03	AE	K93502
GASKETS AND RUBBER COMPONENTS					
G1	Gasket, oil pan (molded rubber) 098/01P	1	92-03	098-321-370	13415R
A5	O'ring pump body	1	92-03	095-321-386	13882
A6	Gasket, w/o lock-up pump to case	1	92-94	095-321-385-A	13883
A6	Gasket, w/lock-up pump to case	1	95-03	01M-321-385	13884
G22	Gasket, end housing (molded rubber) 098	1	92-94	098-321-488	13419R
G22	Gasket, end housing (molded rubber) 01P	1	95-03	01P-321-493	13420R
G38	O'ring case connector	1	92-03	095-325-381-A	13886
n/i	Gasket solenoid to valve body	7	92-03	n/a	13890
n/i	O'ring filler tube	1	92-03	003-321-419-A	13887
n/i	O'ring input shaft	1	92-03	01M-323-255	13888
METAL CLAD SEALS					
A40	Seal, metal clad front	1	92-03	095-321-243-D	93200
E42	Seal, metal clad pinion pinion shaft	1	92-03	098-323-862-A	93208
F43	Seal, axle spine cap right axle	1	92-94	002-517-289-A	93211
F45	Seal, metal clad right axle	1	92-03	097-409-399-B	40205
F46	Seal, metal clad left axle	1	92-03	097-409-399-B	40205
F47	Seal, axle spine cap left axle	1	95-03	020-409-289-B	93210
G48	Seal, metal clad shift shaft	1	92-03	095-321-182-B	93209
SEALING RINGS					
K10	Kit, sealing ring 098/01P	1	92-03	AE	K93300
CLUTCH PLATES					
A79	Friction .063" 6.096" od 32T intermediate clutch (B-2)	4/6	92-03	095-323-465-D	93105
A80	Steel .079" 5.361" id 3T intermediate clutch (B-2)	5/7	92-03	097-323-463-A	93106
B82	Steel .079" 4.095" id 32T reverse clutch (K-2)	4/5	92-03	109701	93104
B83	Friction .063" 4.800" od 24T reverse clutch (K-2)	4/5	92-03	095-323-241-A	93101
C85	Friction .063" 4.800" od 24T forward clutch (K-1)	4/5	92-03	095-323-241-A	93101
C86	Steel .079" 4.095" id 32T forward clutch (K-1)	4/5	92-94	109701	93104
C86	Steel .057" 4.095" id 32T forward clutch (K-1)	4/5	95-03	109701-145	93104A
C88	Steel .079" 2.835" id 26T 3/4 clutch (K-3)	3/5	92-94	109707	93108
C88	Steel .059" 2.835" id 28T 3/4 clutch (K-3)	3/4	95-03	109717-145	93108A
C89	Friction .063" 3.771" od 22T 3/4 clutch (K-3)	4/6	92-94	095-323-941-A	93107
C89	Friction .063" 4.057" od 22T 3/4 clutch (K-3)	3/4	95-03	095-323-941-C	93107A
D91	Steel .079" 5.078" id 12T low/reverse clutch (B-1)	6	92-94	095-323-227	93110
D91	Steel .057" 5.078" id 12T low/reverse clutch (B-1)	6	95-03	095-323-227-A	93110A
D92	Friction .063" 5.743" od 50T (smooth) low/reverse clutch (B-1)	4/6	92-94	095-323-231-A	93103
D92	Friction .063" 5.743" od 50T (groved) low/reverse clutch (B-1)	4/6	95-03	095-323-231-C	93103A
PRESSURE PLATES					
A100	Pressure plate (apply) intermediate clutch (B-2)	sel	92-03	AE	93713-R
A101	Pressure plate .089" 3T intermediate clutch (B-2)	sel	92-03	097-323-463-A	93106A
A101	Pressure plate .095" 3T intermediate clutch (B-2)	sel	92-03	097-323-463-B	93106B
A101	Pressure plate .108" 3T intermediate clutch (B-2)	sel	92-03	097-323-463-G	93106C
A101	Pressure plate .118" 3T intermediate clutch (B-2)	sel	92-03	097-023-463-C	93106D
A101	Pressure plate .128" 3T intermediate clutch (B-2)	sel	92-03	097-323-463-D	93106E

ILL	DESCRIPTION	QTY	YEAR	REFERENCE #	PART #	
PRESSURE PLATES (CONTINUED)						
A101	Pressure plate .138" 3T	intermediate clutch (B-2)	sel	92-03	097-323-463-E	93106F
A101	Pressure plate .148" 3T	intermediate clutch (B-2)	sel	92-03	097-323-463-F	93106G
B102	Pressure plate (apply)	reverse clutch (K2)	1	92-03	AE	93722-R
B103	Pressure plate .200" flat	reverse clutch (K2)	sel	92-94	AE	93714-R
B103	Pressure plate .250" flat	reverse clutch (K2)	sel	95-03	AE	93714A-R
C104	Pressure plate (beveled) (apply)	forward clutch (K-1)	1	92-03	AE	93716-R
C105	Pressure plate .185" flat	forward clutch (K-1)	1	92-03	AE	93715-R
C106	Pressure plate .210" flat (apply)	3/4 clutch (K3)	1	92-03	AE	93717-R
C107	Pressure plate (stepped)	3/4 clutch (K3)	sel	92-03	AE	93718-R
C107	Pressure plate .215" (stepped)	3/4 clutch (K3)	sel	92-03	AE	93719-R
C107	Pressure plate .235" (stepped)	3/4 clutch (K3)	sel	92-03	AE	93720-R
D108	Pressure plate .285" (beveled) (apply)	low/reverse clutch (B1)	sel	92-03	095-323-297-A	93721-R
D108	Pressure plate .405" (beveled) (apply)	low/reverse clutch (B1)	sel	92-03	095-323-297-B	93721A-R
D109	Pressure plate .525" flat	low/reverse clutch (B1)	1	92-03	AE	93721B-R
FILTERS						
K10	Kit, filter	098/01P	1	92-95	AE	FK97800
K10	Kit, filter	098/01P	1	96-03	AE	FK97800A
G115	Filter, oil	098/01P	1	92-95	095-325-429-C	93800
G116	Filter, oil	098/01P	1	96-03	01M-325-429	93800A
BUSHINGS						
K13	Kit, bushing	098-01P	1	92-03	AE	K93901
A125	Bushing	098-01P (pump body)	1	92-03	n/a	93005
WASHERS/BEARINGS/RACES/SHIMS						
A155	Washer, thrust	pump to reverse housing	1	92-03	095-321-285	93401
B158	Washer, thrust	reverse housing to forward housing	sel	92-03	095-323-345	93403
B159	Washer, thrust	input shaft	1	92-03	49596203	93404
PUMP PARTS AND PUMPS						
A240	Pump assembly	098/01P	1	92-03	AE	97910-R
HARD PARTS						
A255	Plate, cushion waved .055"	intermediate clutch (B-2)	1	92-03	095-323-471	93120
B265	Plate, cushion waved .059"	reverse clutch (K-2)	1	92-03	n/a	93121
B273	Spring, diaphragm	forward clutch (K-1)	1	92-03	AE	93701-R
C280	Spring, diaphragm	3/4 clutch (K-3)	1	92-03	095-323-295-A	93702-R
D290	Spring, diaphragm	low/reverse clutch (B-1)	1	92-03	095-323-295-A	93703-R
D291	Pressure plate (apply)	low/reverse clutch (B-1)	1	92-03	n/a	93722-R
ELECTRICAL COMPONENTS						
n/i	Solenoid	EPC	1	92-03	095-927-333	5A-245
n/i	Solenoid	TCC	1	95-03	095-927-333	5A-245
n/i	Solenoid	Shift	5/6	92-03	095-927-331	5A-246
G378	Harness, internal - heavy duty	098/01P	1	92-03	350-0070	16A-155
SPRAGS						
D395	Sprag, low/reverse	098/01P	1	92-03	095-323-383	93512
BONDED PISTONS						
A400	Piston, bonded rubber	intermediate clutch (B2)	1	92-03	095-321-531-C	93503
B402	Piston, bonded rubber	reverse clutch (K-2)	1	92-03	095-323-121-E	93504
B404	Piston, bonded rubber	forward clutch (K1)	1	92-94	098-323-217-B	93505
B404	Piston, bonded rubber	forward clutch (K1)	1	95-03	095-323-217-G	93506
B404	Piston, bonded rubber (balance)	forward clutch (K1)	1	95-03	095-323-257	93510
C406	Piston, bonded rubber	3/4 clutch (K3)	1	92-94	095-323-927-A	93507
C406	Piston, bonded rubber	3/4 clutch (K3)	1	95-03	095-323-927-G	93508
C406	Piston, bonded rubber (balance)	3/4 clutch (K3)	1	95-03	095-323-977-C	93511
D408	Piston, bonded rubber	low/reverse clutch (B-1)	1	92-03	095-323-479	93509
n/i	Kit, bonded piston	098/01P	2	92-94	AE	K93501

ILL	DESCRIPTION	QTY	YEAR	REFERENCE #	PART #
BONDED PISTONS (CONTINUED)					
n/i	Kit, bonded piston 098/01P	1	95-03	AE	K93502
NOTES					

098•01P

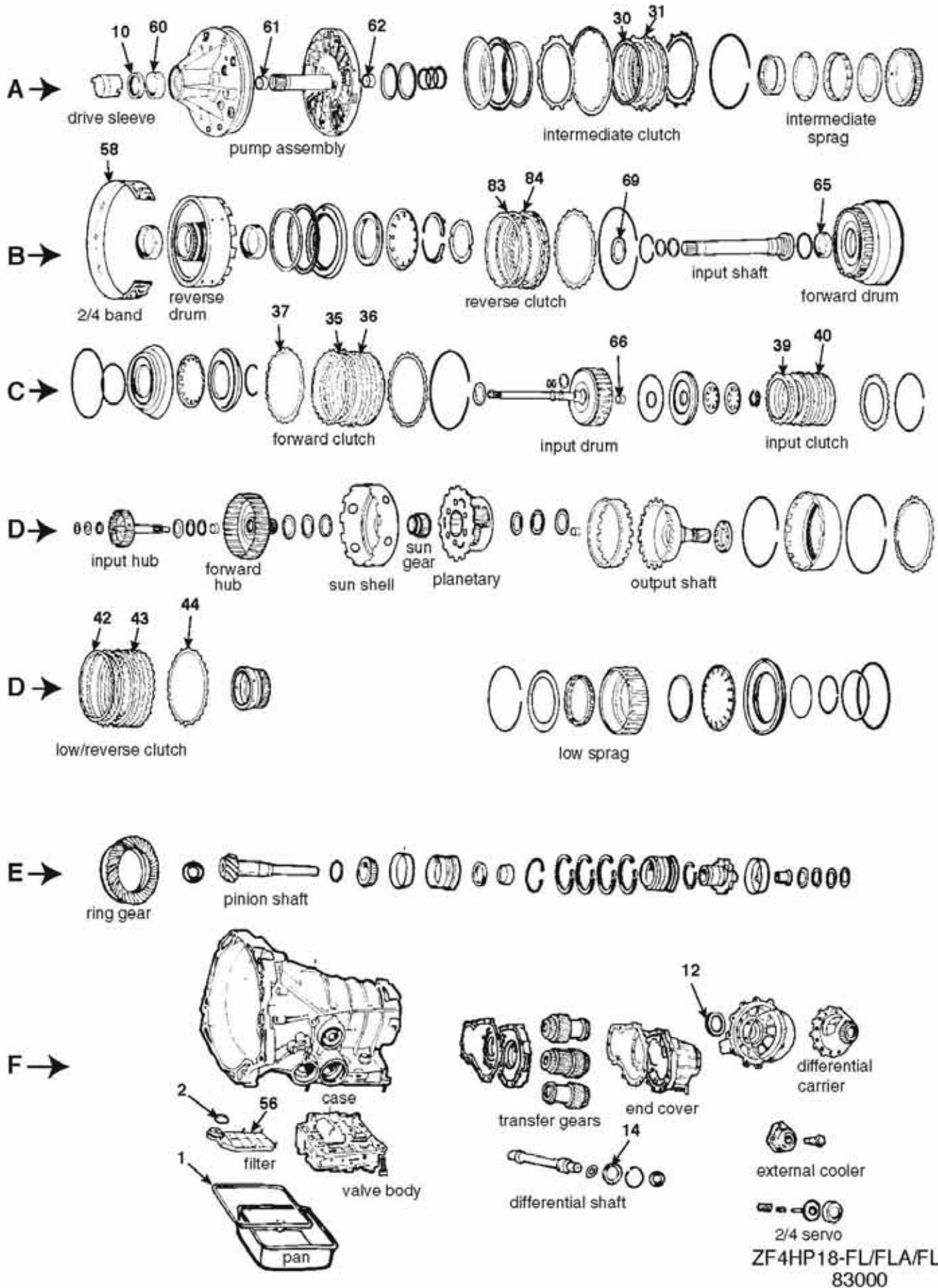

ZF4HP18-FL/FLA/FLE
83000

ILL	DESCRIPTION	QTY	YEAR	REFERENCE #	PART #
TECHNICAL MANUALS					
n/i	Tech manual ZF4HP18FL dis/assembly diagnosis/troubleshooting	1	88-99	83-ZF4HP18TM	010-404
REBUILDER KITS					
K5	Master kit w/steels ZF4HP18-FL	1	88-99	AE	K8300
K6	Master kit w/o steels ZF4HP18-FL	1	88-99	AE	K8300-LS
K7	O/H gasket set w/seals-rings ZF4HP18-FL	1	88-99	AE	K83900
GASKETS AND RUBBER COMPONENTS					
F1	Gasket, oil pan molded rubber	1	88-99	01F-321-371	13412R
F2	Seal, lathe cut filter	1	88-99	n/a	13419
n/i	Gasket filter housing	1	88-99	n/a	13415
METAL CLAD SEALS					
A10	Seal, metal clad pump	1	88-99	83505225	83151
F12	Seal, metal clad 62x45x8mm right axle (outer)	1	88-99	83805052	83152
n/i	Seal, metal clad 42x32x7mm right axle (inner)	1	88-99	n/a	83153
F14	Seal, metal clad 62x35x10mm left axle (outer)	1	88-99	83805053	83154
n/i	Seal, metal clad 55x40x7mm left axle (inner)	1	88-99	n/a	83155
n/i	Seal, metal clad 70x53x7mm pinion	2	88-99	83505264	82159
n/i	Seal, metal clad 12x22x7mm manual lever shaft	1	88-99	0634-300-040	46202
n/i	Seal, metal clad speedometer gear	1	88-99	FU03-27-238	65202
SEALING RINGS					
K10	Kit, sealing ring ZF4HP18-FL	1	88-99	AE	K83300
CLUTCH PLATES					
A30	Friction .063" 5.625" od 48T (C) intermediate overrun clutch	3	88-99	1050-210-053	56106A
A31	Steel .071" 4.728" id 12T (C) intermediate overrun clutch	3	88-99	24231-205-935	56101
B33	Friction .079" 5.792" od 30T (B) reverse clutch	3	88-99	1050-202-004	83103
B34	Steel .071" 5.204" id 24T (B) reverse clutch	3	88-99	1050-302-011	83100
C35	Friction .063" 5.778" od 30T (A) forward clutch	5	88-99	1050-202-002	83101
C36	Steel .071" 5.204" id 24T (A) forward clutch	5	88-99	1050-302-011	83100
C37	Steel, waved .040" 5.204" id 24T (A) forward clutch	1	88-99	1050-302-012	83115
C39	Friction .063" 4.250" od 36T (E) input clutch	5	88-99	1050-230-033	83107
C40	Steel .071" 3.079" id 30T (E) input clutch	5	88-99	1050-230-059	83104
D42	Friction .063" 5.778" od 30T (D) low/reverse clutch	6	88-99	1050-217-002	83101
D43	Steel .071" 5.204" id 24T (D) low/reverse clutch	6	88-99	1050-302-011	83100
D44	Steel, waved .040" 5.204" id 24T (D) low/reverse clutch	1	88-99	1050-302-012	83115
FILTERS					
K9	Kit, Filter Premier/Monaco (ZF4HP18FL)	1	88-99	AE	FK83800
F56	Filter Premier/Monaco (ZF4HP18-FL)	1	88-99	83504685	83800
F56	Filter Audi (ZF4HP18FLE)	1	88-99	01F-325-433	83800C
F56	Filter Porsche (ZF4HP18FLA/E)	1	91-99	943-607-011-02	83800A
BANDS					
B58	Band, flex ZF4HP18FL (intermediate brake)	1	88-99	0501-207-503	83700
B58	Band, flex ZF4HP18FLA/FLE (intermediate brake)	1	91-99	0501-210-101	83700A
BUSHINGS					
K13	Kit, bushing 5 pieces	1	88-99	AE	K83901
K13	Kit, bushing 2 pieces (input and stator shaft)	1	88-99	AE	K83902
A60	Bushing pump	1	88-92	n/a	83001
A61	Bushing stator support (front)	1	88-92	n/a	83007
A62	Bushing stator support (rear)	1	88-92	n/a	56003
B65	Bushing turbine shaft (rear)	1	88-92	n/a	83006
C66	Bushing input drum	1	88-92	n/a	83002
WASHERS/BEARINGS/RACES/SHIMS					
B69	Thrust washer forward clutch drum	1	88-99	0730-150-726	83401

A Measurable Difference in Transmission Filter Performance

FILTRAN



FILTRAN
PREMIUM Brand Filters



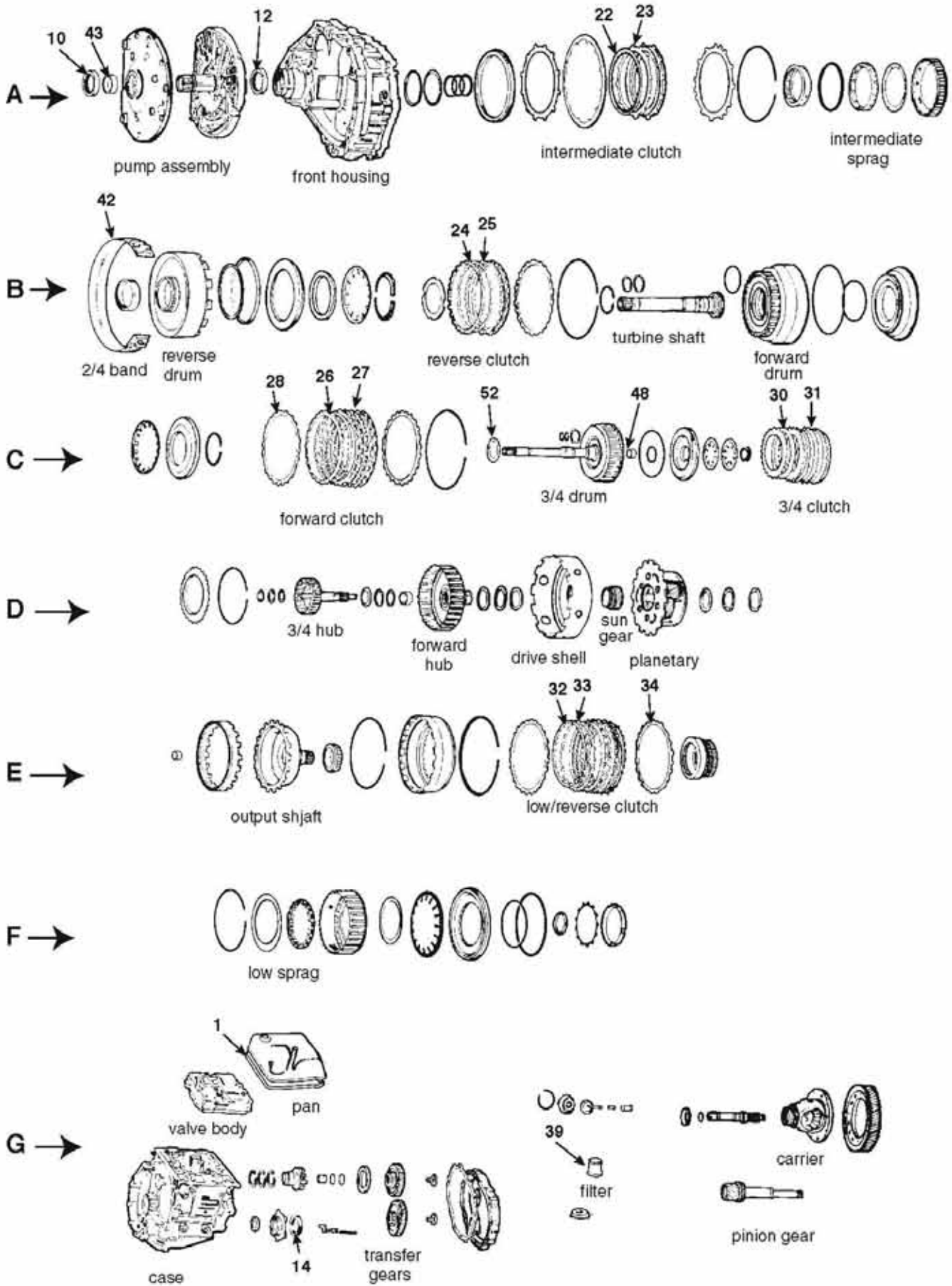

ILL	DESCRIPTION	QTY	YEAR	REFERENCE #	PART #	
TECHNICAL MANUALS						
K53	Tech manual ZF4HP18FL dis/assembly	diagnosis/troubleshooting	1	86-98	83-ZF4HP18TM	010-404
K53	Tech manual supplement ZF4HP18Q	changes to 4HP18FL	1	86-98	83-ZF4HP18QTM	010-464
REBUILDER KITS						
K5	Master kit w/steels	ZF4HP18Q	1	86-98	AE	K8600
K6	Master kit w/o steels	ZF4HP18Q	1	86-98	AE	K8600-LS
K7	O/H gasket set w/seals-rings	ZF4HP18Q	1	86-98	AE	K86900
GASKETS AND RUBBER COMPONENTS						
G1	Gasket, oil pan	ZF4HP18Q	1	86-98	01F-321-371	13412R
n/i	O'Ring, oil filter	large 51.4x2.9mm	1	86-98	n/a	23080
n/i	O'Ring, oil filter	small 49.8x2.0mm	1	86-98	n/a	23081
METAL CLAD SEALS						
A10	Seal, metal clad	front	1	86-98	83505225	83151
A12	Seal, metal clad	left axle	1	90-98	8721078	86154
A12	Seal, metal clad	Alfa Romeo 164 (left and right axle)	2	86-98	0750-111-220	86155
G14	Seal, metal clad	right axle	1	86-98	8724878	86153
n/i	Seal, metal clad	speedo gear housing	1	86-98	FU03-27-238	65202
n/i	Seal, metal clad 12x22x7mm	shift shaft	1	86-98	0634-300-040	46202
SEALING RINGS						
K10	Kit, sealing ring	ZF4HP18Q	1	86-98	AE	K83300
CLUTCH PLATES						
A22	Friction .063" 5.625" od 48T	(C) intermediate clutch	3	86-98	1043-217-002	56106A
A23	Steel .071" 4.728" id 12T	(C) intermediate clutch	3	86-98	1043-317-062	56101
B24	Friction .079" 5.792" od 30T	(B) reverse clutch	3	90-98	1056-272-024	83103
B24	Friction (not in kit)	Alpha Romeo (B) reverse clutch	3/4	91-95	1056-210-031	83103A
B25	Steel .071" 5.204" id 24T	(B) reverse clutch	3	86-98	1050-302-011	83100
C26	Friction .063" 5.778" od 30T	(A) forward clutch	5	86-98	1050-202-035	83101
C27	Steel .071" 5.204" id 24T	(A) forward clutch	5	86-98	1050-302-011	83100
C28	Steel, waved .040" 5.204" id 24T	(A) forward clutch	1	86-98	1050-302-012	83115
C30	Friction .063" 4.250" od 36T	(E) 3rd/4th clutch	5	86-98	1050-230-032	83107
C31	Steel .071" 3.079" id 30T	(E) 3rd/4th clutch	5	86-98	1050-230-059	83104
E32	Friction .063" 5.778" od 30T	(D) low/reverse clutch	6	86-98	1050-217-002	83101
E33	Steel .071" 5.204" id 24T	(D) low/reverse clutch	6	86-98	1050-302-011	83100
E34	Steel, waved .040" 5.204" id 24T	(D) low/reverse clutch	1	86-98	1050-302-012	83115
FILTERS						
G39	Filter, oil	ZF4HP18Q	1	86-98	1050-311-497	86800
BANDS						
B42	Band, flex	ZF4HP18FL	1	86-98	0501-207-503	83700
BUSHINGS						
K13	Kit, bushing	2 pcs - input and stator shaft	1	86-98	AE	K83902
K13	Kit, bushing	5 pieces	1	86-98	AE	K86901
A43	Bushing	front pump body	1	86-98	n/a	86001
C48	Bushing	3rd/4th housing	1	86-98	n/a	83002
n/i	Bushing	pump stator (front)	1	86-98	n/a	83007
n/i	Bushing	pump stator (rear)	1	86-98	n/a	56003
n/i	Bushing	turbine shaft (rear)	1	86-98	n/a	83006
WASHERS/BEARINGS/RACES/SHIMS						
C52	Thrust washer	3rd/4th housing	1	86-98	0730-150-726	83401
PUMP PARTS AND PUMPS						
n/a	Pump assembly	ZF4HP18Q	1	86-98	AE	86200-R
NOTES						

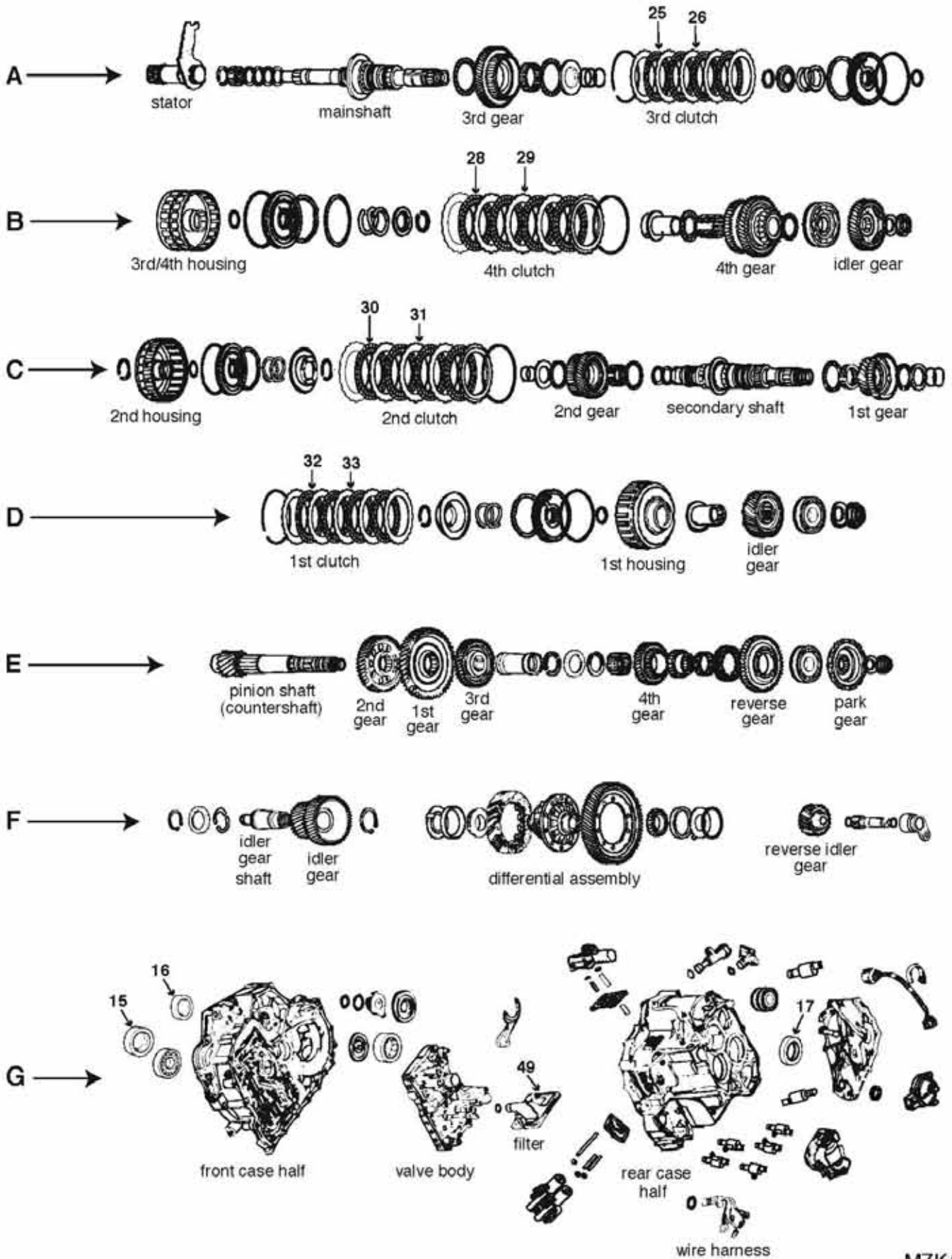

MZKA
60185-

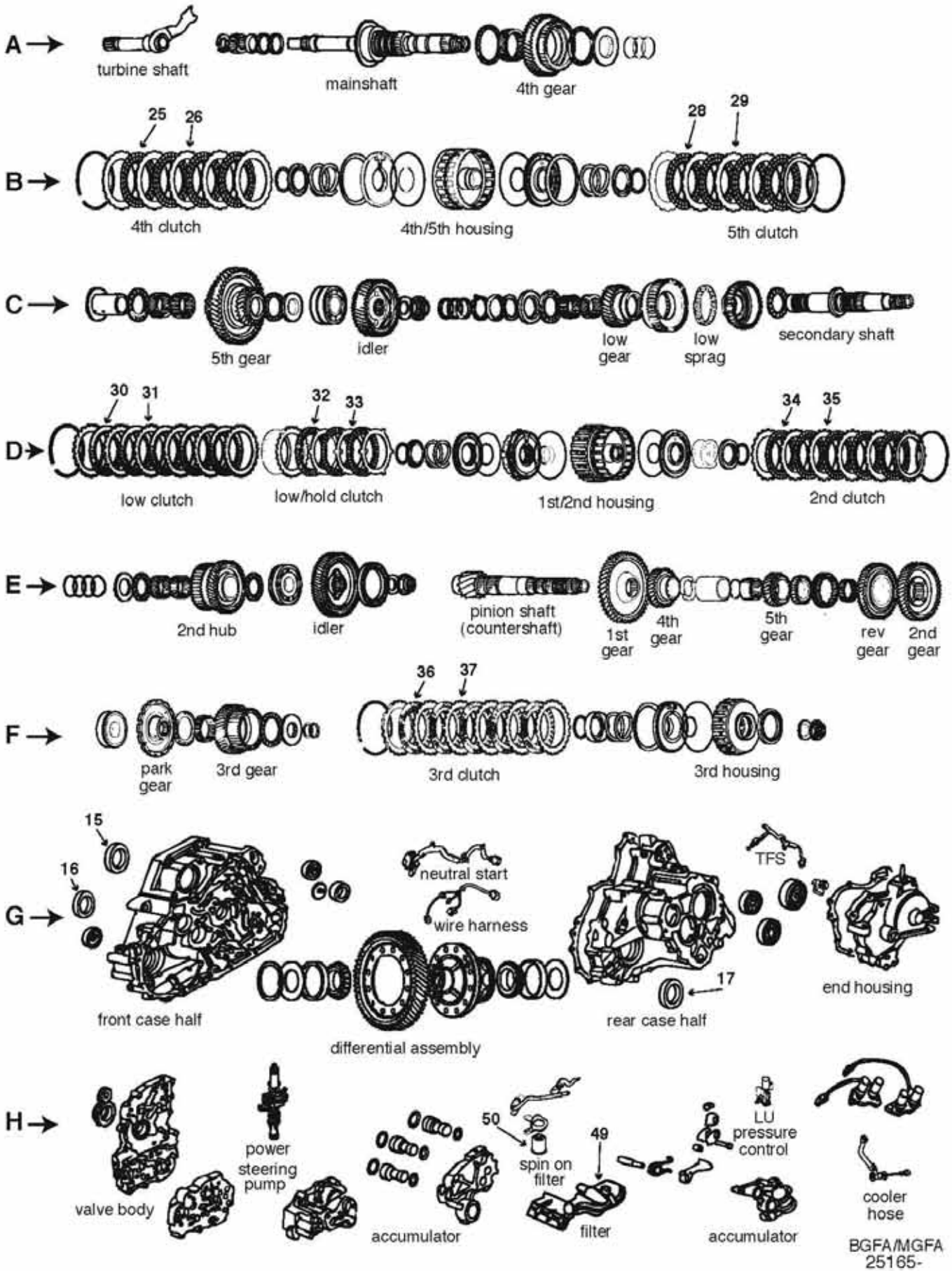

BGFA/MGFA
25165-

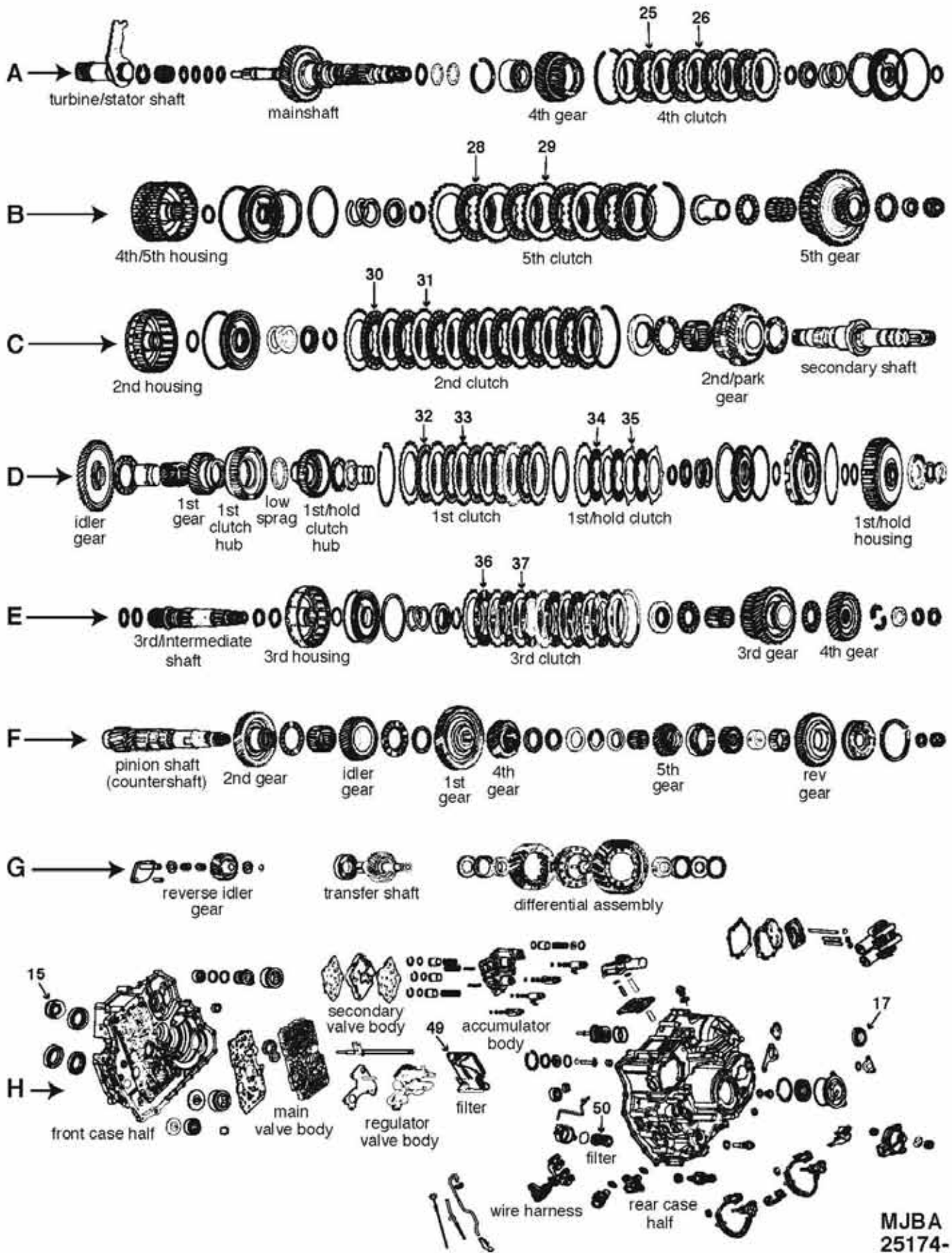

MJBA
25174-

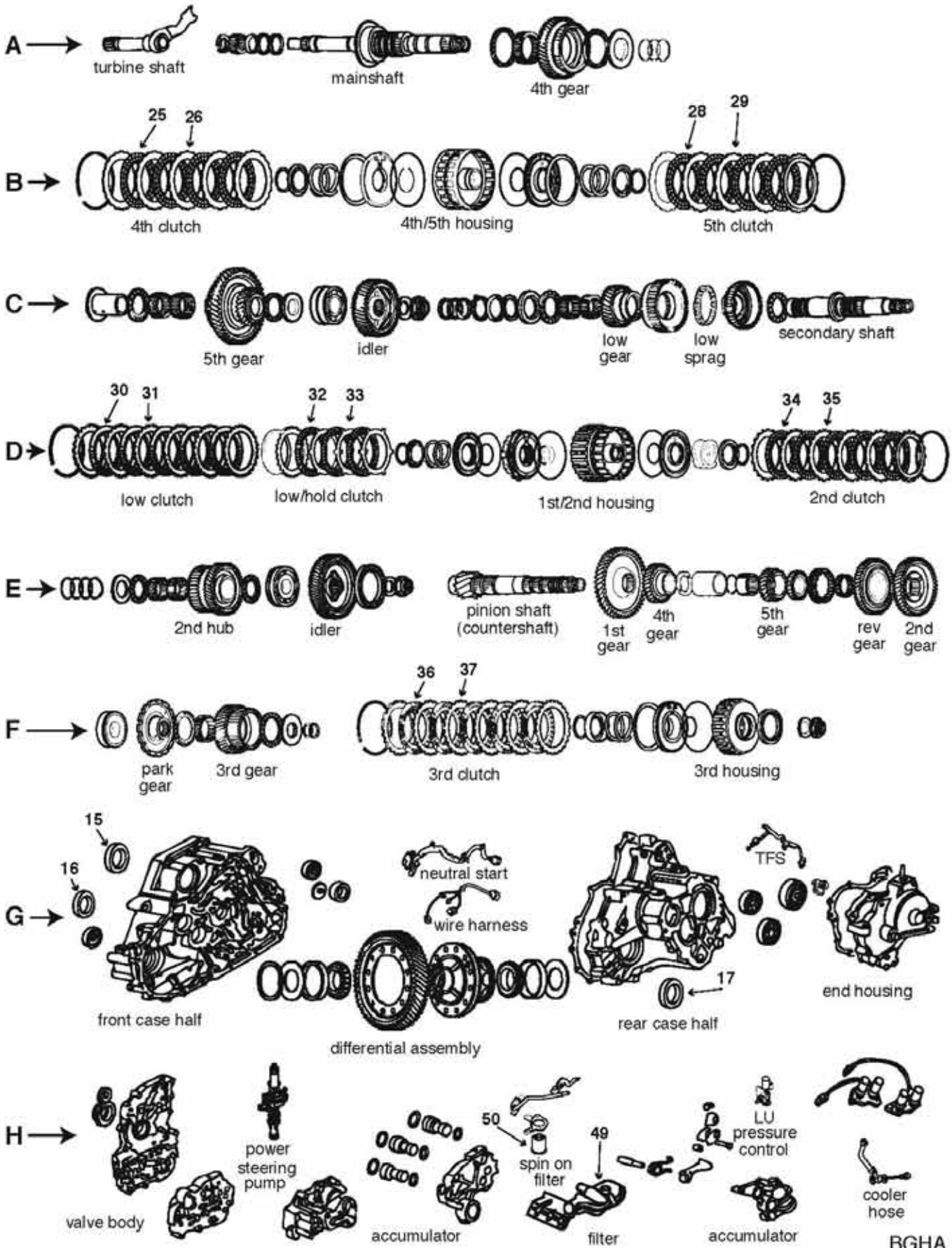

BGHA
25165-

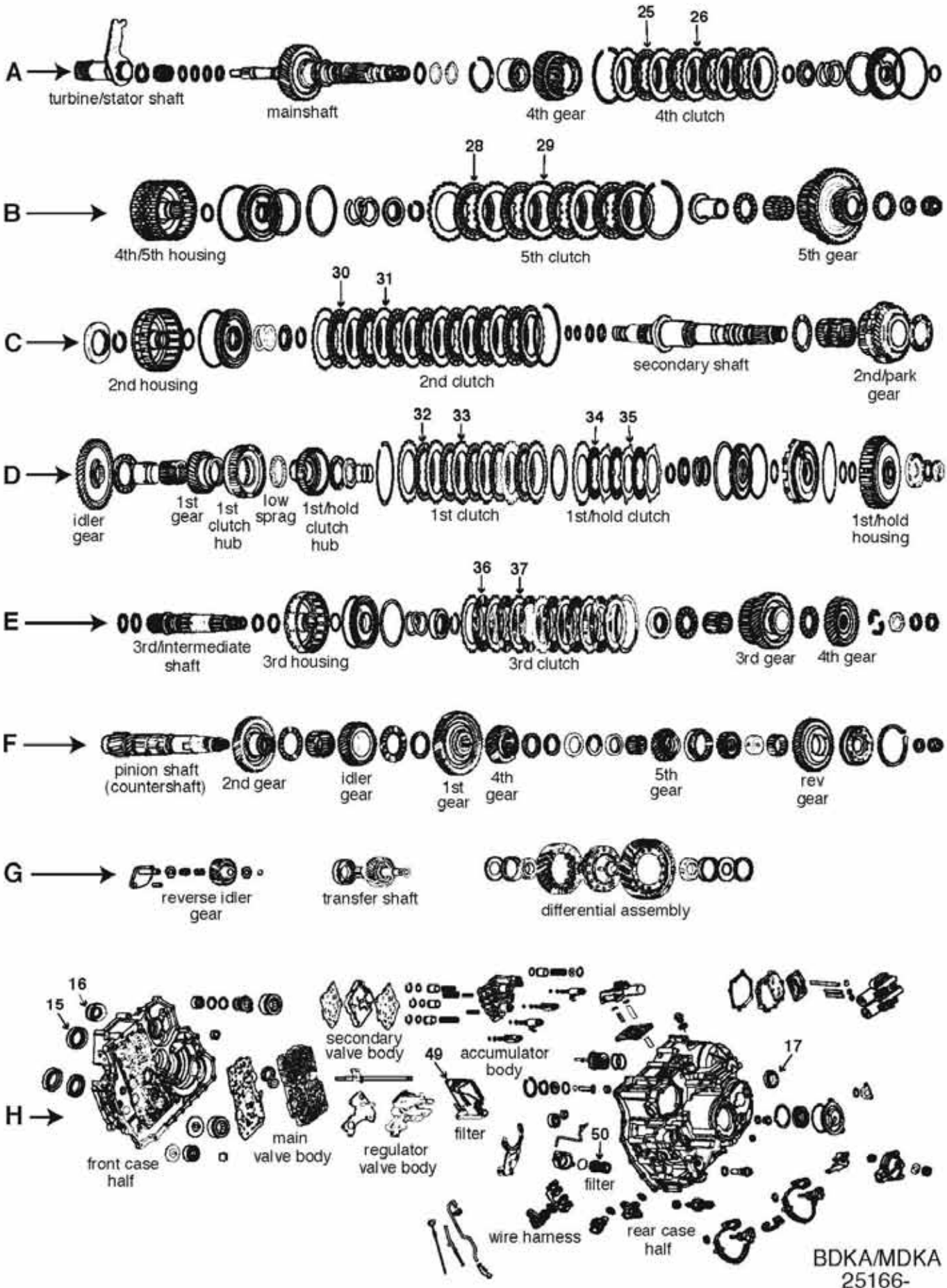

BDKA/MDKA
25166-

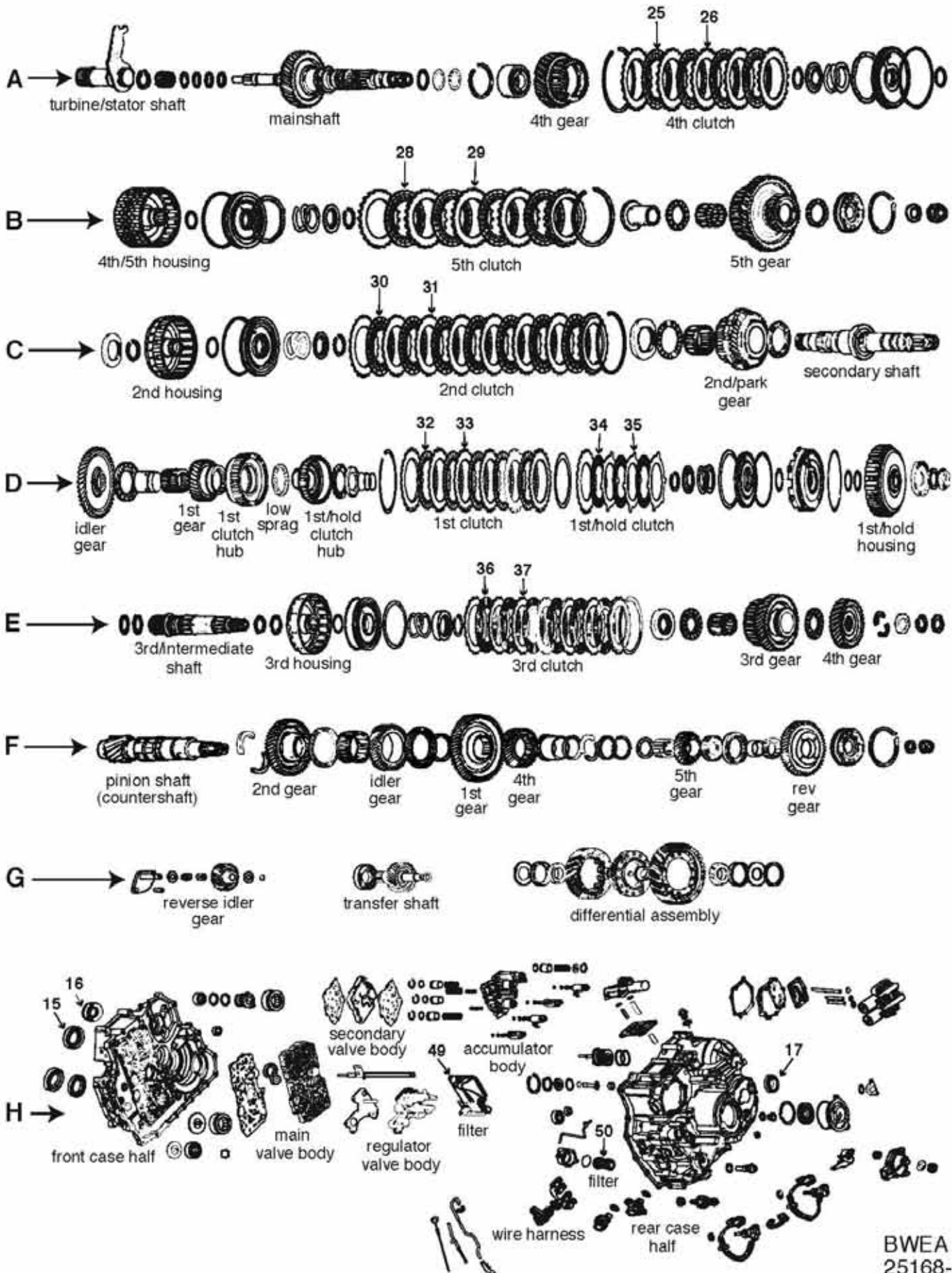

BWEA 25168-

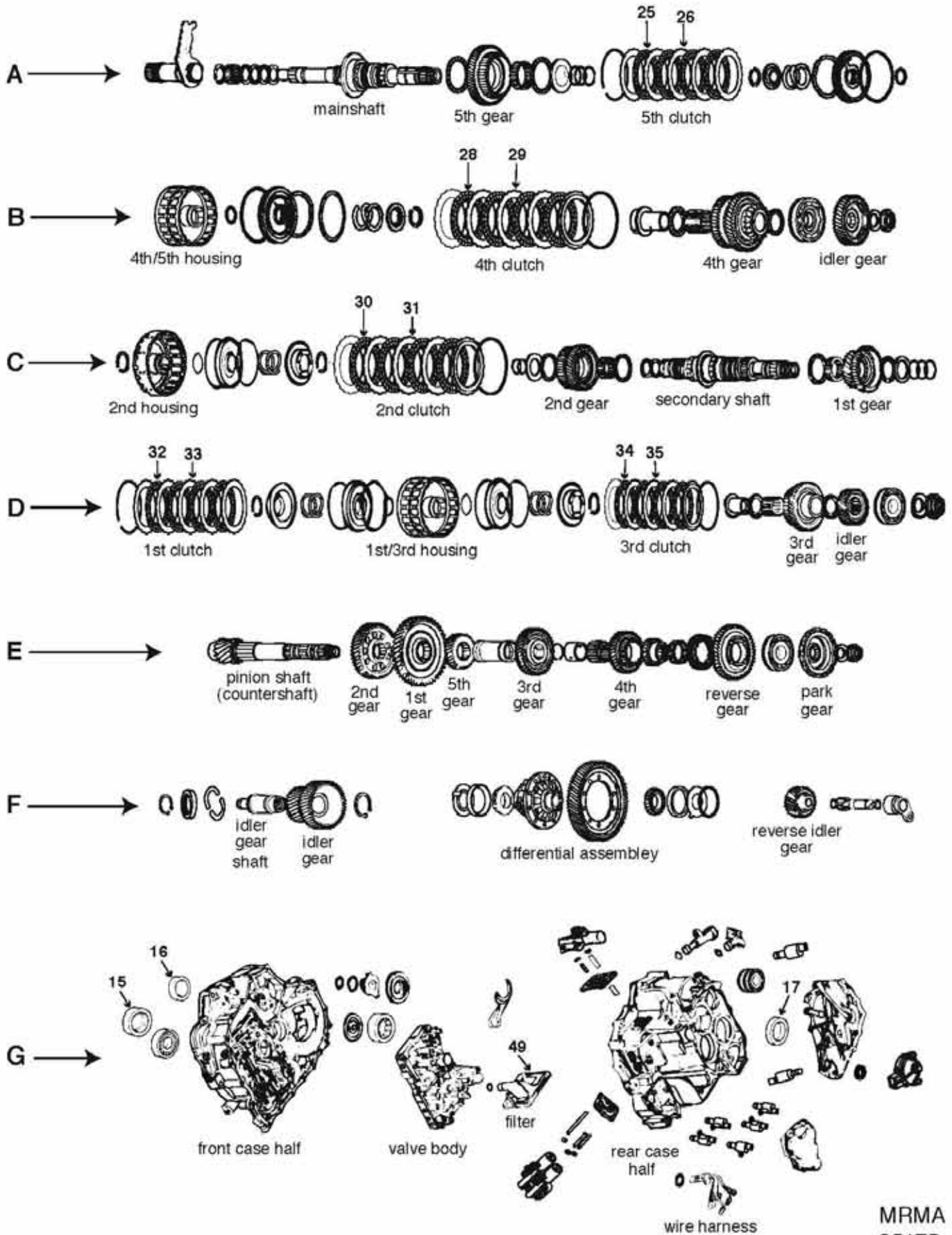

MRMA
25175-

ILL	DESCRIPTION		QTY	YEAR	REFERENCE #	PART #
REBUILDER KITS						
K5	Master kit w/steels	MRMA	1	02-06	161901	25175-11104
K6	Master kit w/o steels	MRMA	1	02-06	161904LS	25175-12104
K7	O/H gasket set w/o seals-rings	MRMA	1	02-06	2430	25175-13104
METAL CLAD SEALS						
G15	Seal, metal clad 44x68x8mm	front	1	02-06	91206-p0Z-005	50201A
G17	Seal, metal clad 40x56x9mm	left axle	1	02-06	91205-P0X-005	50210
G16	Seal, metal clad 35x54x8mm	right axle	1	02-06	91207-P7Z-003	50228
CLUTCH PLATES						
A25	Friction .077" 4.846" od 44T	5th clutch	3	02-06	22564-PRP-003	50131
A26	Steel .079" 44T (waved)	5th clutch	3	02-06	22653-PRP-003	25175-37904
B28	Friction .077" 4.846" od 44T	4th clutch	3	02-06	22564-PRP-003	50131
B29	Steel .079" 44T (waved)	4th clutch	3	02-06	22653-PRP-003	25175-37904
C30	Friction .076" 4.728" od 44T	2nd clutch	4	02-06	22544-PRP-003	50105
C31	Steel .079" 44T (waved)	2nd clutch	3	02-06	22643-PRP-003	25175-37804
C31	Steel .079" 3.664" id 24T	2nd clutch	4/4	02-06	22643-PRP-003	50110
D32	Friction .076" 4.728" od 44T	1st (low) clutch	4	02-06	22544-PRP-003	50105
D33	Steel .079" 5.020" id 20T (waved)	1st (low) clutch	4	02-06	22543-PRP-003	25175-37604
D34	Friction .076" 4.728" od 44T	3rd clutch	4	02-06	22544-PRP-003	50105
D35	Steel .079" 5.020" id 20T (waved)	3rd clutch	4	02-06	22543-PRP-003	25175-37604
D35	Steel .079" 20T	3rd/low clutch	1	02-06	22543-PRP-901	25175-37704
FILTERS						
G49	Filter, oil screen	MRMA	1	02-06	25420-PRP-003	25175-45004
NOTES						

MRMA

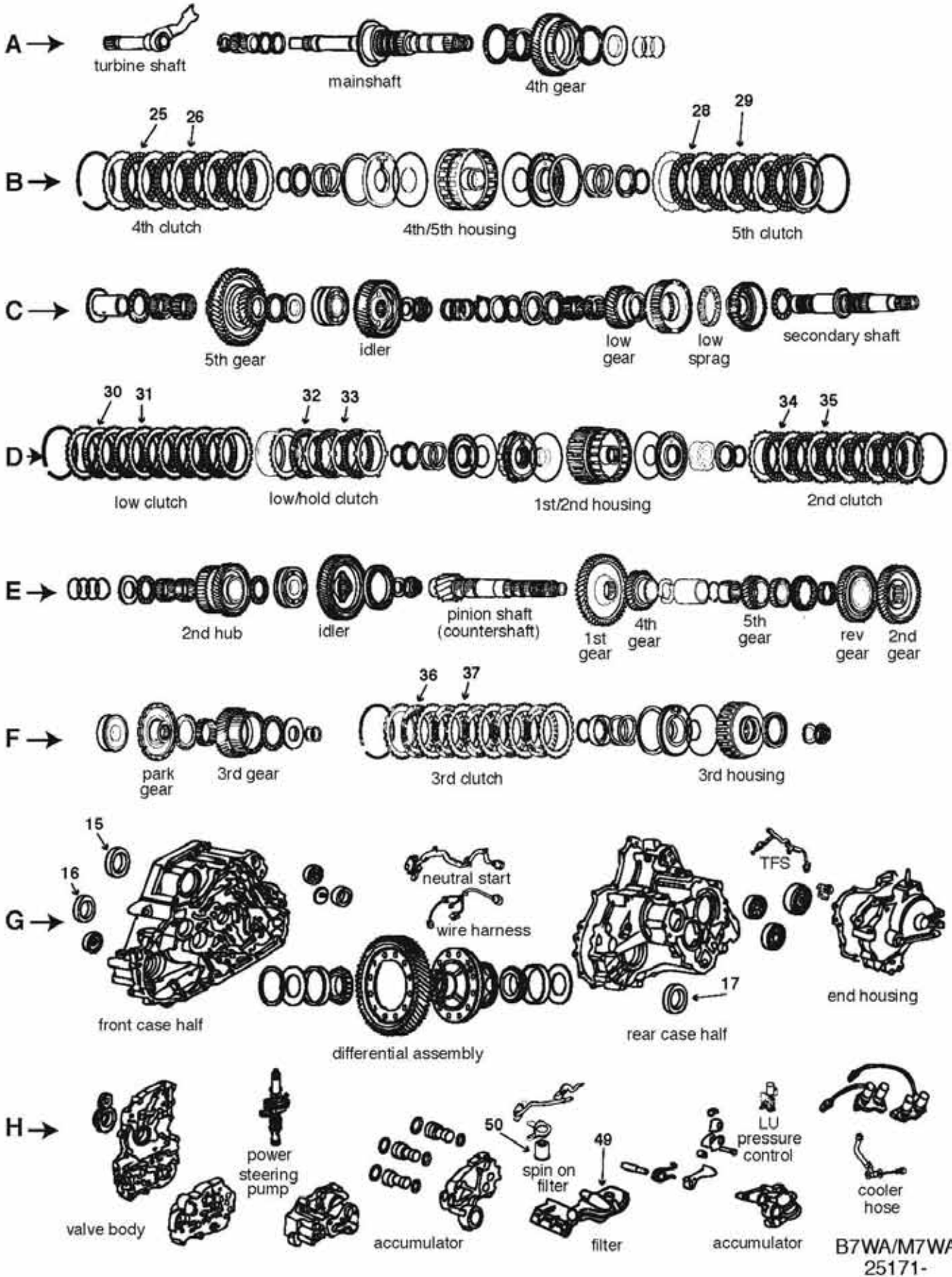

B7WA/M7WA
25171-

ILL	DESCRIPTION		QTY	YEAR	REFERENCE #	PART #
REBUILDER KITS						
K5	Master kit w/steels	B7WA	1	00-05	146901	25171-11104
K6	Master kit w/o steels	B7WA	1	00-05	146901LS	25171-12104
K7	O/H gasket set w/seals-rings	M7WA/B7WA/BDGA	1	00-05	FDB-2401	25171-13104
METAL CLAD SEALS						
G15	Seal, metal clad 44x68x8mm	front	1	00-05	91206-P0Z-005	50201A
G16	Seal, metal clad 40x56x9mm	left axle	1	00-05	91205-P0X-005	50210
G17	Seal, metal clad 35x54x8mm	right axle	1	00-05	91207-P7Z-003	50228
CLUTCH PLATES						
B25	Friction .077" 5.043" od 44T	4th clutch	4	00-05	134702-195	50135
B26	Steel .078" 3.664" id 20T (narrow teeth)	4th clutch	4	00-05	134703-200	50138
B28	Friction .077" 5.043" od 44T	5th clutch	4	00-05	134702-195	50135
B29	Steel .091" 3.664" id 20T	5th clutch	4	00-05	134703-230	50136
D30	Friction .076" 5.190" od 49T	1st (low) clutch	5	00-05	116702	50141
D31	Steel .063" 4.070" id 24T	1st (low) clutch	5	00-05	146701-160	25171-37504
D32	Friction .076" 4.728" od 44T	low-hold clutch	3	00-05	078700G	50105
D33	Steel .071" 3.677" id 6T	low-hold clutch	3	00-05	146703-180	25171-37704
D34	Friction .077" 5.020" od 30T	2nd clutch	6	00-05	22544-PGH-A02	25167-35104
D35	Steel .063" 3.751" id 20T	2nd clutch	6	00-05	146705-160	25171-37604
F36	Friction .077" 4.727" od 40T	3rd clutch	5	00-05	22544-P7W-003	25167-35204
F37	Steel .091" 3.463" id 20T	3rd clutch	5	00-05	146707-230	25171-37804
FILTERS						
H49	Filter, oil screen (internal)	M7WA/B7WA	1	00-05	25420-P7W-003	50800R
H50	Filter, external spin on	M7WA/B7WA	1	00-05	25450-P7W-003	25171-45104
NOTES						

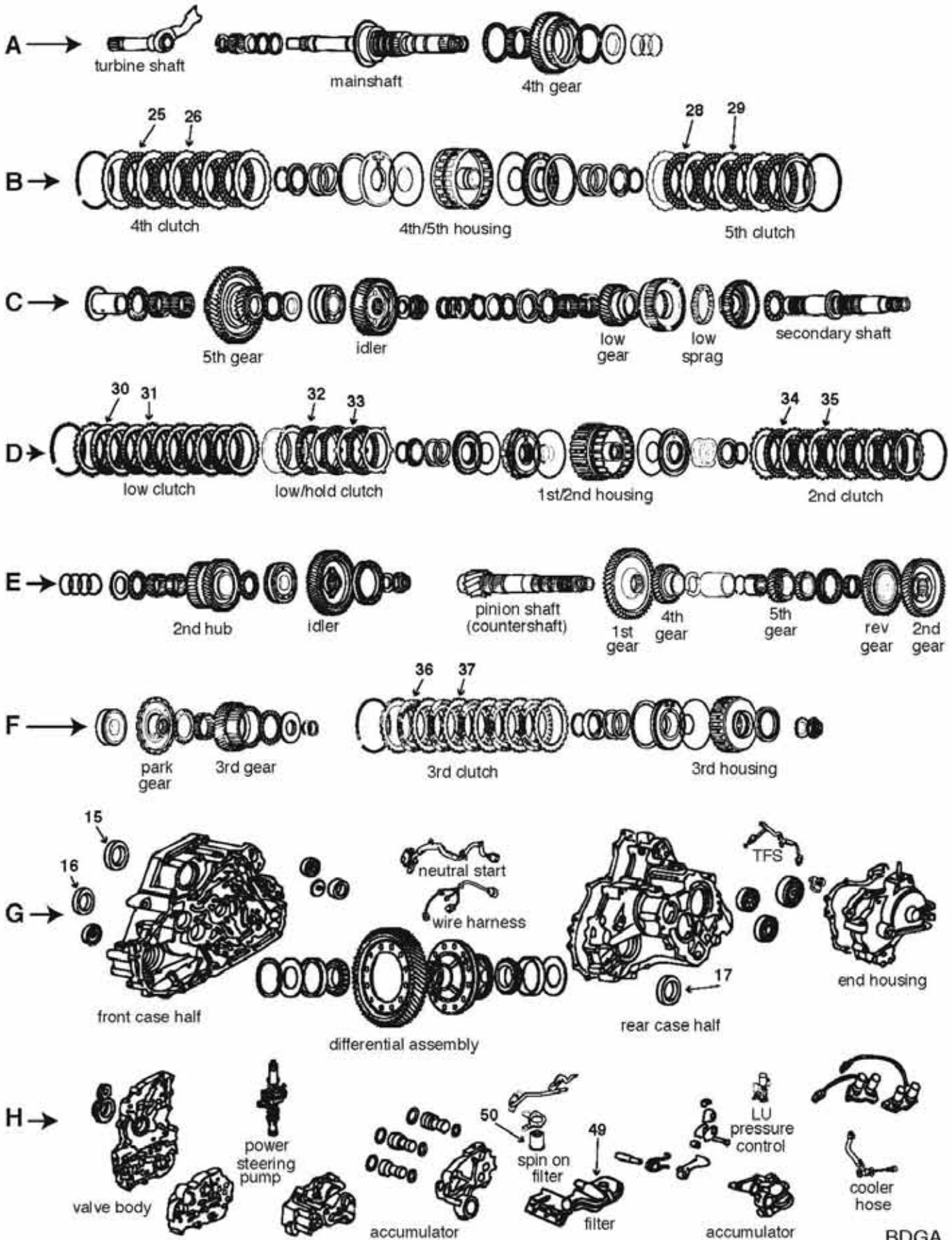

BDGA
25167-

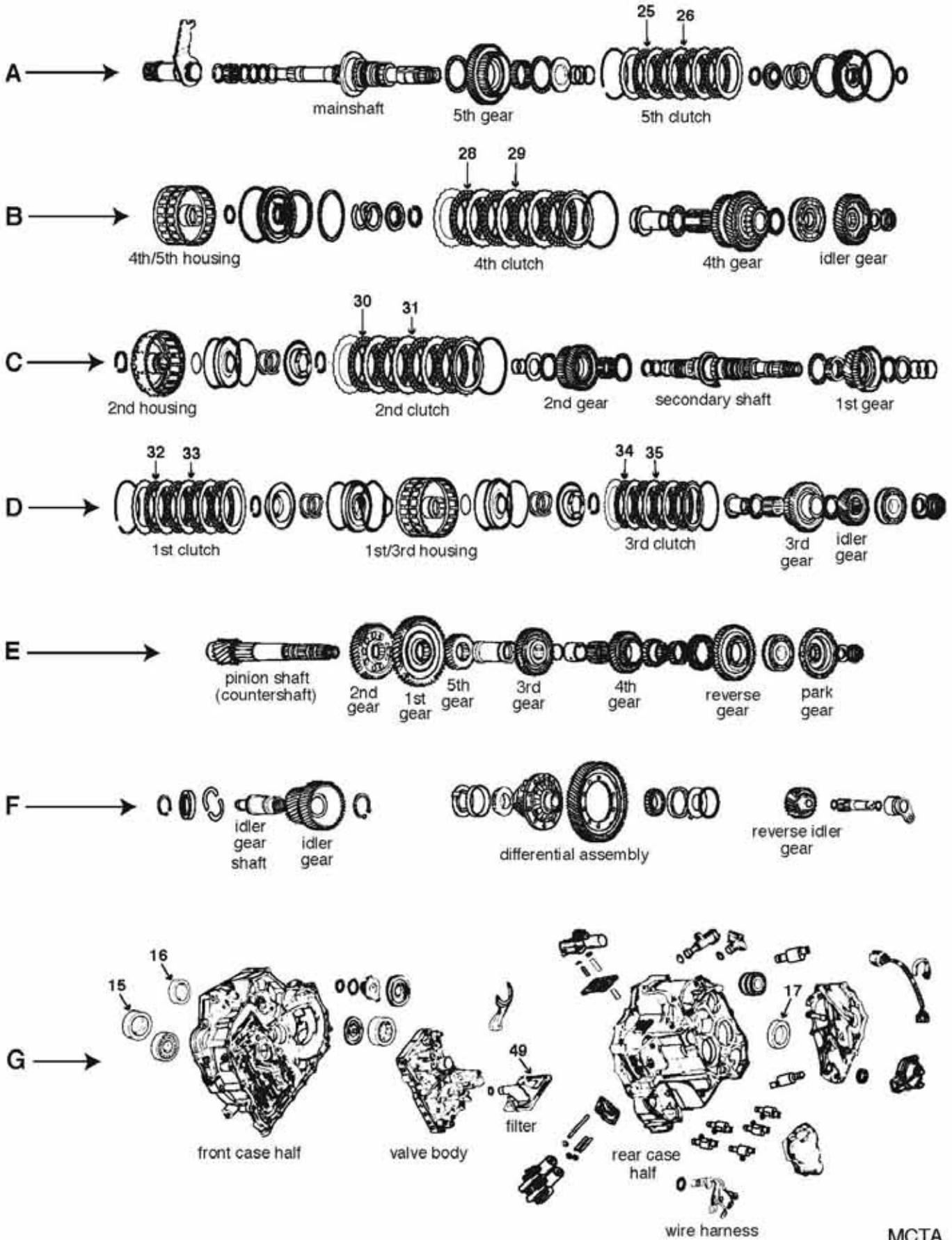

MCTA
25172-

ILL	DESCRIPTION		QTY	YEAR	REFERENCE #	PART #
REBUILDER KITS						
K5	Master kit w/steels	MCTA	1	04-04	177901	25172-11104
K5	Master kit w/steels	MCTA	1	05-11	AE	25172-11114
K6	Master kit w/o steels	MCTA	1	04-04	177901LS	25172-12104
K6	Master kit w/o steels	MCTA	1	05-11	AE	25172-12114
K7	O/H gasket set w/o seals-rings	MCTA	1	04-11	2430	25175-13104
METAL CLAD SEALS						
G15	Seal, metal clad 44x68x8mm	converter housing	1	04-11	91206-P0Z-005	50201A
G16	Seal, metal clad	right axle	1	04-11	91206-PHR-003	60211-30300
G17	Seal, metal clad 40x56x9mm	left axle	1	04-11	91205-POX-005	50210
CLUTCH PLATES						
A25	Friction .076" 4.728" od 44T	5th clutch	4	04-04	22544-PRP-003	50105
A25	Friction .077" 4.846" od 44T	5th clutch	4	05-11	22546-RFK-003	50131
A26	Steel .079" 3.664" id 24T	5th clutch	4	04-11	22643-RCL-003	50110
B28	Friction .076" 4.728" od 44T	4th clutch	4	04-04	22544-PRP-003	50105
B28	Friction .077" 4.846" od 44T	4th clutch	4	05-11	22546-RFK-003	50131
B29	Steel .079" 3.664" id 24T	4th clutch	4	04-11	22643-RCL-003	50110
C30	Friction .076" 4.728" od 44T	2nd clutch	5	04-04	22545-PRP-013	50105
C31	Steel .057" 3.677" id 24T	2nd clutch	5	04-11	22643-RCL-801	60195-37504
D32	Friction .076" 4.728" od 44T	1st clutch	5	04-11	22544-RCT-004	50105
D33	Steel .063" 3.698" id 30T	1st clutch	5	04-11	22543-RCT-004	25172-37504
D34	Friction .076" 4.728" od 44T	3rd clutch	5	04-11	22544-RCT-004	50105
D35	Steel .063" 3.698" id 30T	3rd clutch	5	04-11	22543-RCT-004	25172-37504
FILTERS						
G49	Filter, oil screen	MCTA	1	04-11	25420-PRP-003	25175-45004
NOTES						

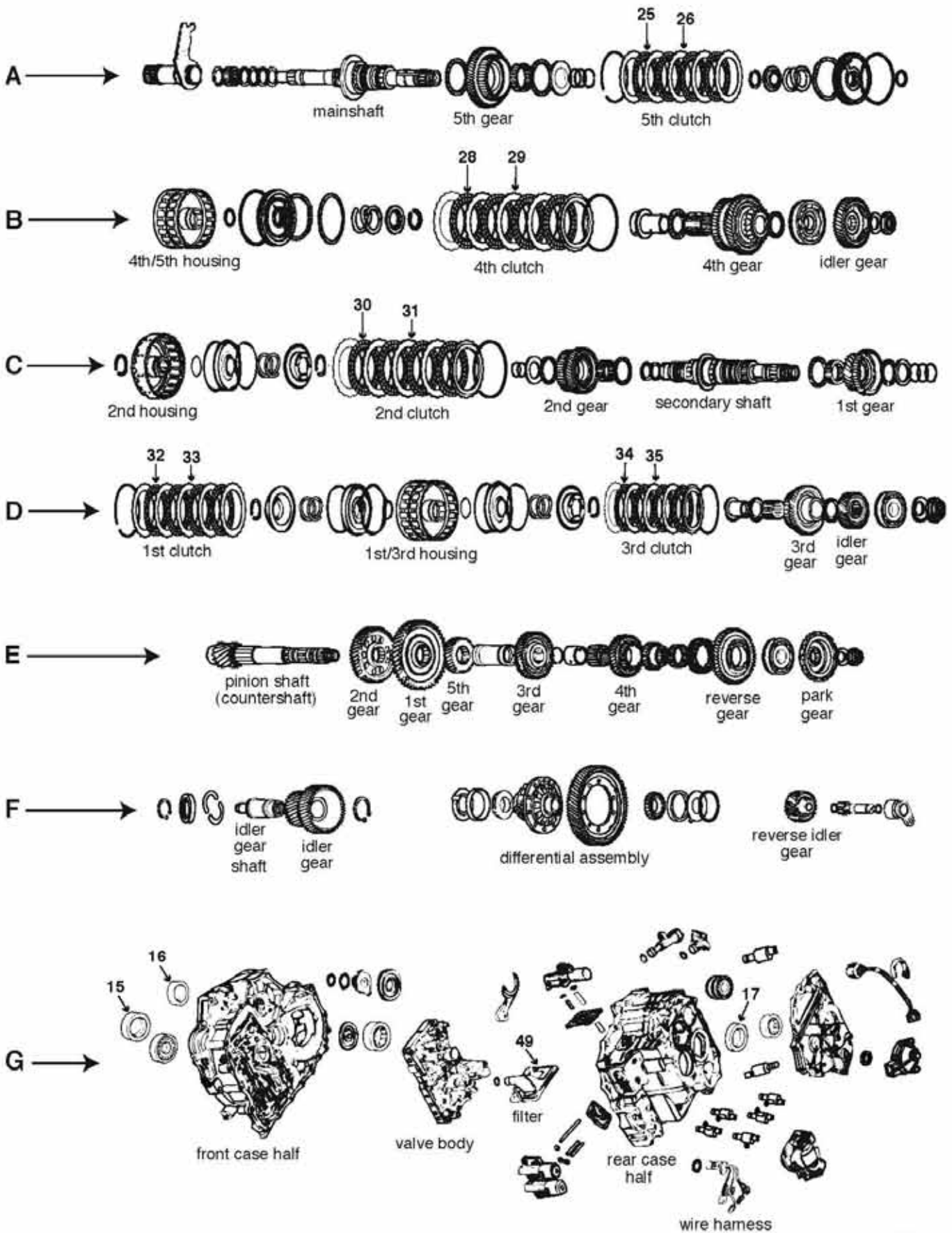

MCLA
60197-

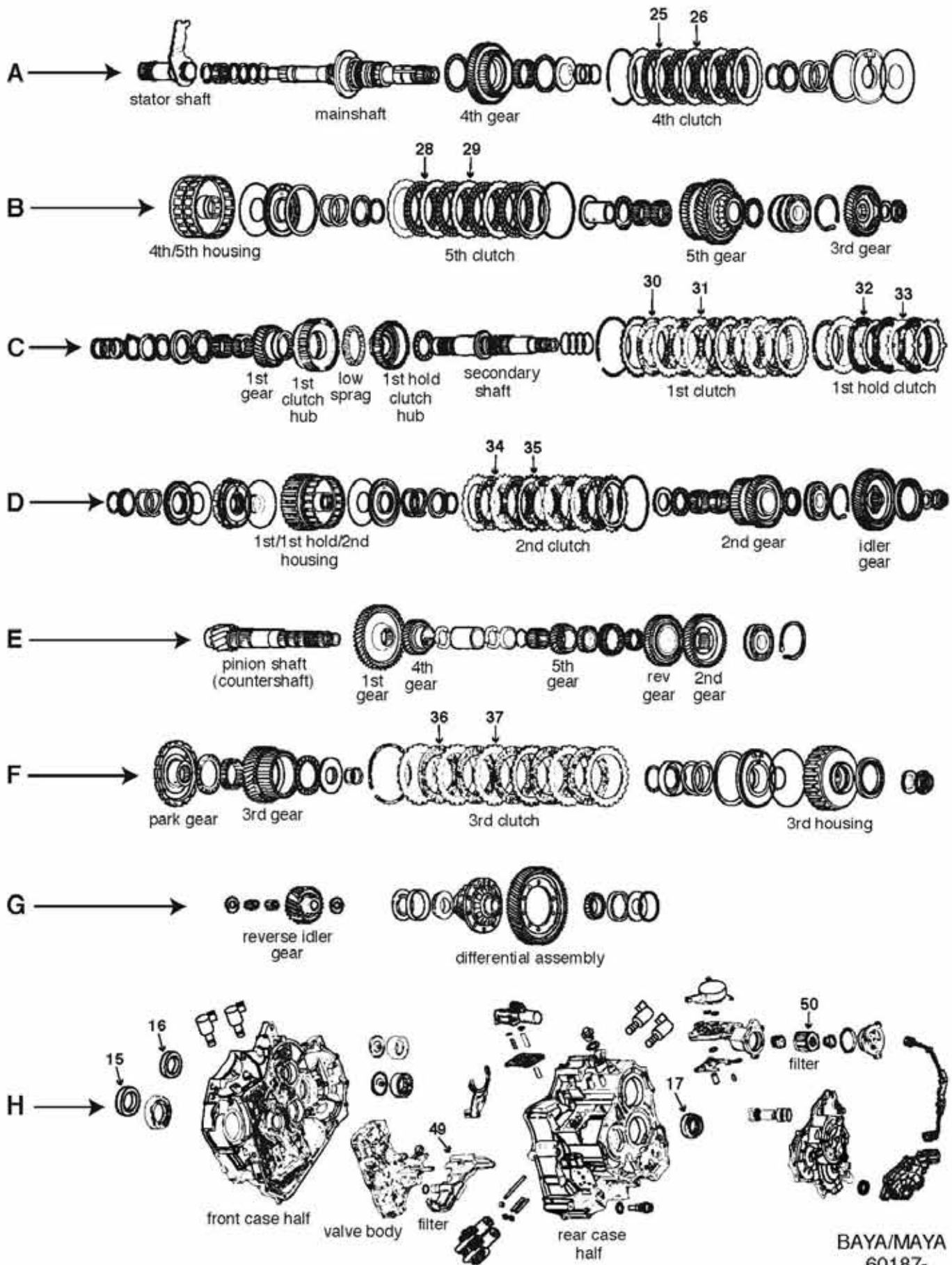

BAYA/MAYA
60187-

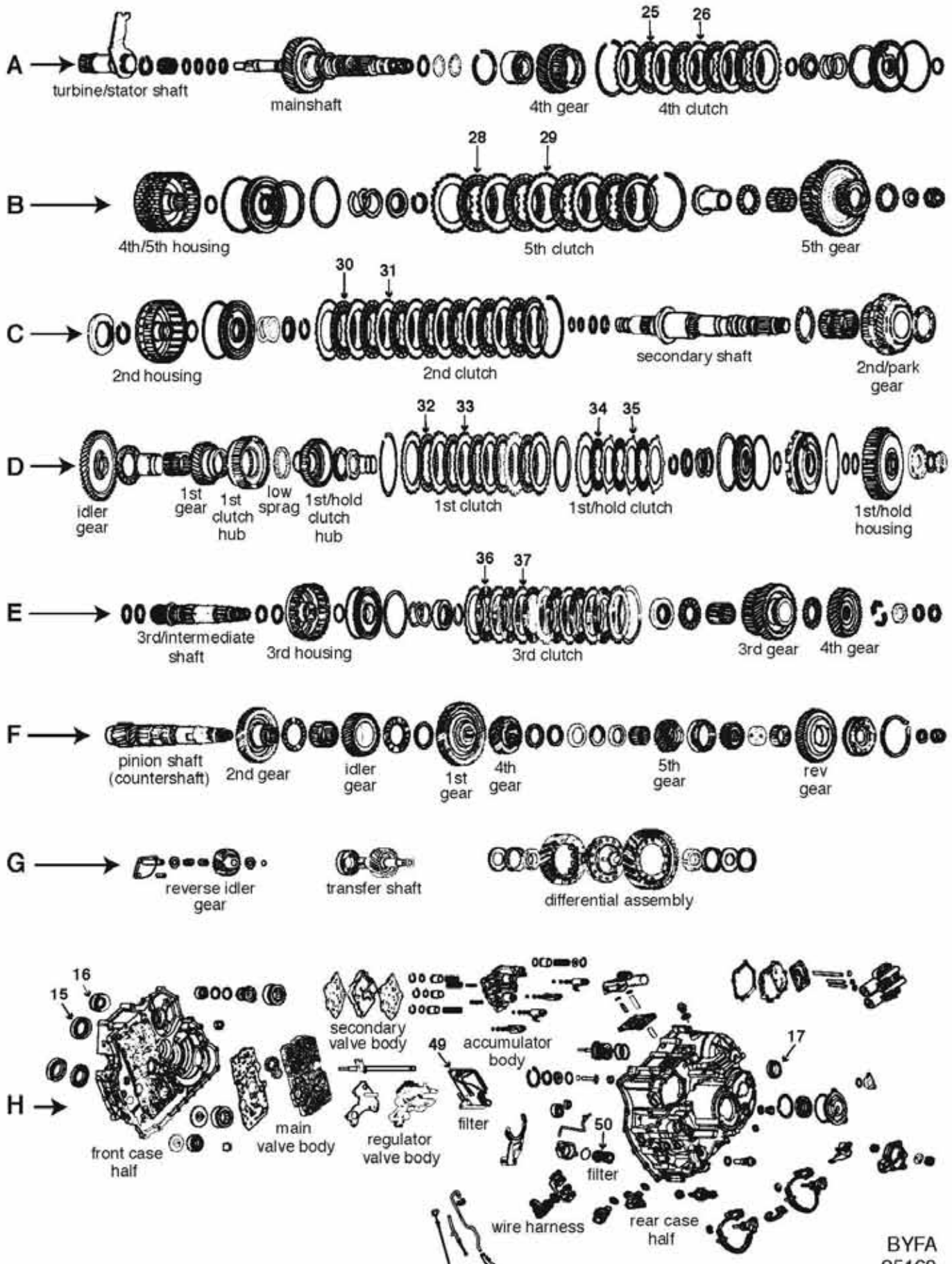

BYFA
25169-

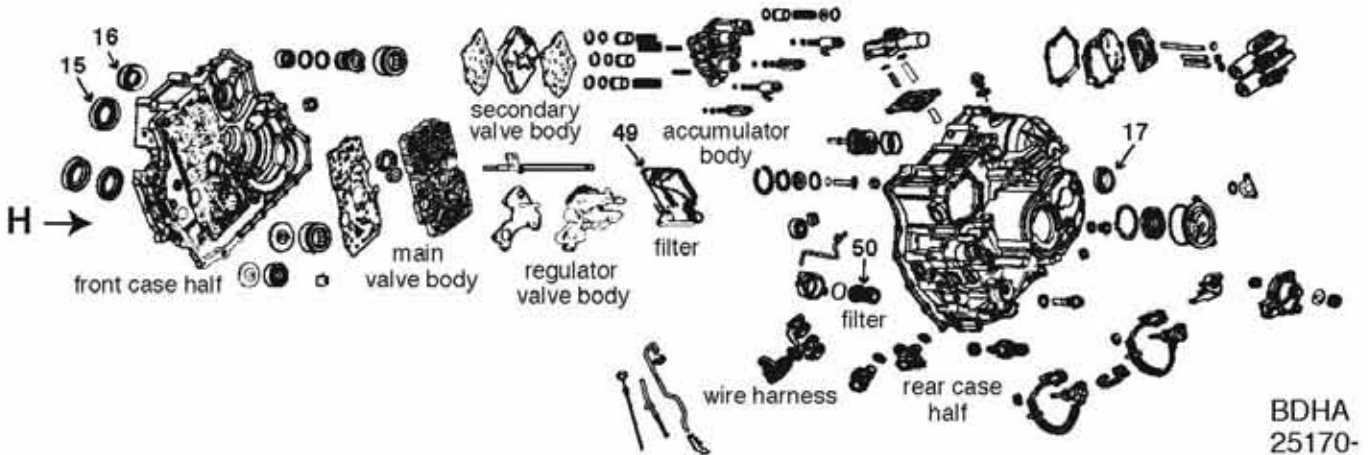
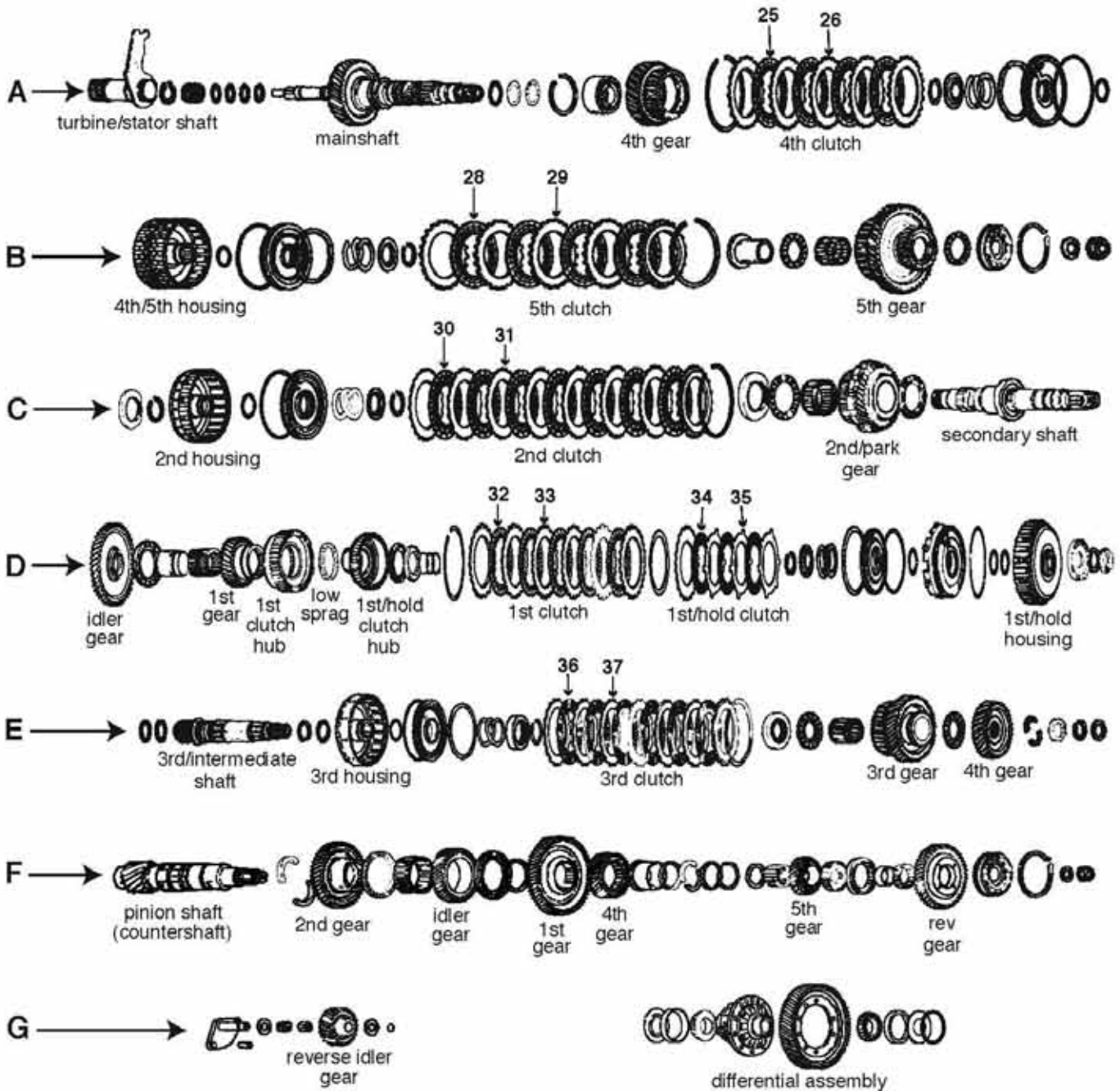

BDHA
25170-

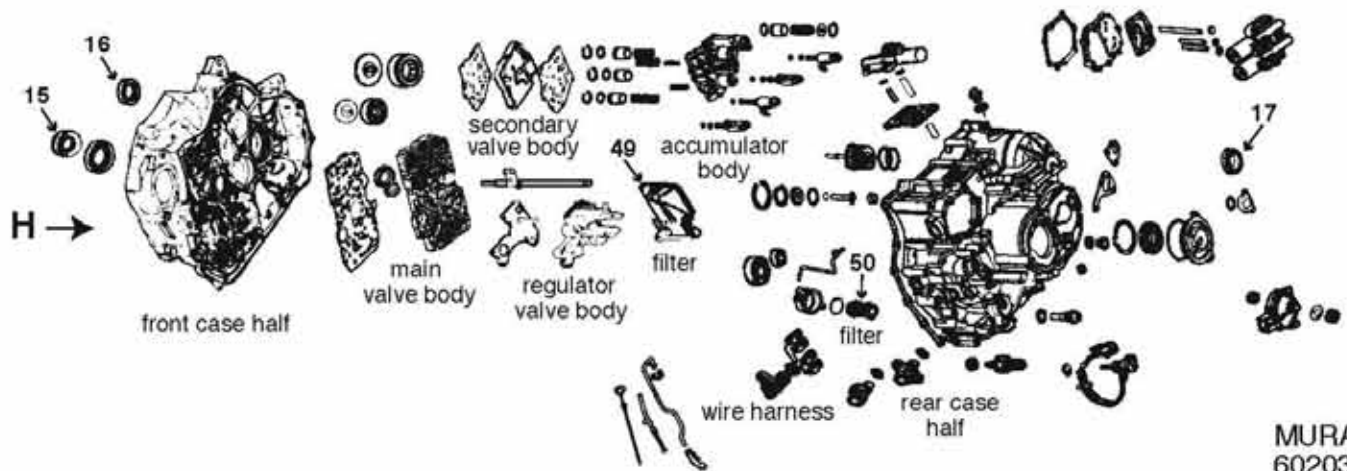
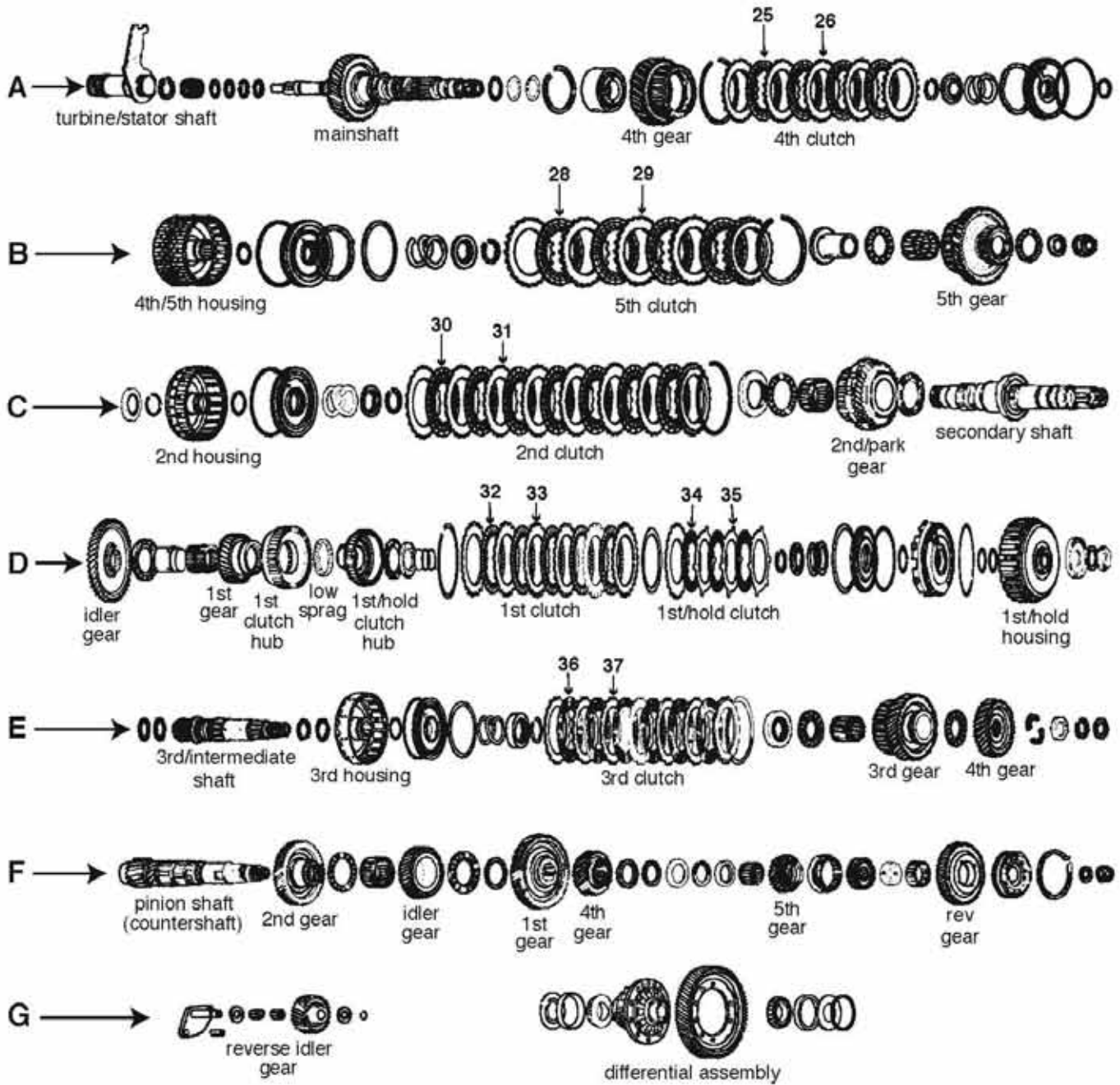

MURA
60203-

ILL	DESCRIPTION		QTY	YEAR	REFERENCE #	PART #
REBUILDER KITS						
K5	Master kit w/steels	MURA	1	05-07	K9800R	60203-11104
K6	Master Kit w/o steels	MURA	1	05-07	K9800R-W/O	60203-12104
K7	O/H gasket set w/seals-rings	MURA	1	05-07	FDB-2479	60203-13004
METAL CLAD SEALS						
H15	Seal, metal clad 44x68x8mm	converter housing	1	05-07	91206-P0Z-005	50201A
H16	Seal, metal clad	right axle	1	05-07	91206-PHR-003	60211-30300
H17	Seal, metal clad 40x56x9mm	left axle	2	05-07	91205-P0X-005	50210
CLUTCH PLATES						
A25	Friction .077" 5.232" od 44T	4th clutch	4	05-07	172708A-195	60203-35104
A26	Steel .079" 3.680" id 24T	4th clutch	4	05-07	172709-200	25166-37704
B28	Friction .077" 5.232" od 44T	5th clutch	4	05-07	172708A-195	60203-35104
B29	Steel .079" 3.680" id 24T	5th clutch	4	05-07	172709-200	25166-37704
C30	Friction .076" 4.700" od 28T	2nd clutch	7	05-07	172704-190	25166-35104
C31	Steel .071" 3.390" id 24T	2nd clutch	7	05-07	172705-180	25166-37504
D32	Friction .076" 5.190" od 49T	1st low clutch	5	05-07	116702	50141
D33	Steel .079" 3.677" id 24T (waved)	1st low clutch	5	05-07	146701-160	25175-37504
D34	Friction 0.091" 4.728" od 44T	low-hold clutch	3	05-07	078700.230	50127
D35	Steel .079" 44T (waved)	low-hold clutch	3	05-07	146703-180	25175-37804
E36	Friction .076" 5.300" od 42T	3rd clutch	5	05-07	172706-190	25166-35404
E37	Steel .079" 3.464" id 20T	3rd clutch	5	05-07	172707-200	25166-37604
FILTERS						
H49	Filter, oil screen	MURA	1	05-07	n/a	60203-45004
H50	Filter, cooler line (cartridge type)	MURA	1	05-07	25450-P4V-013	50711
NOTES						

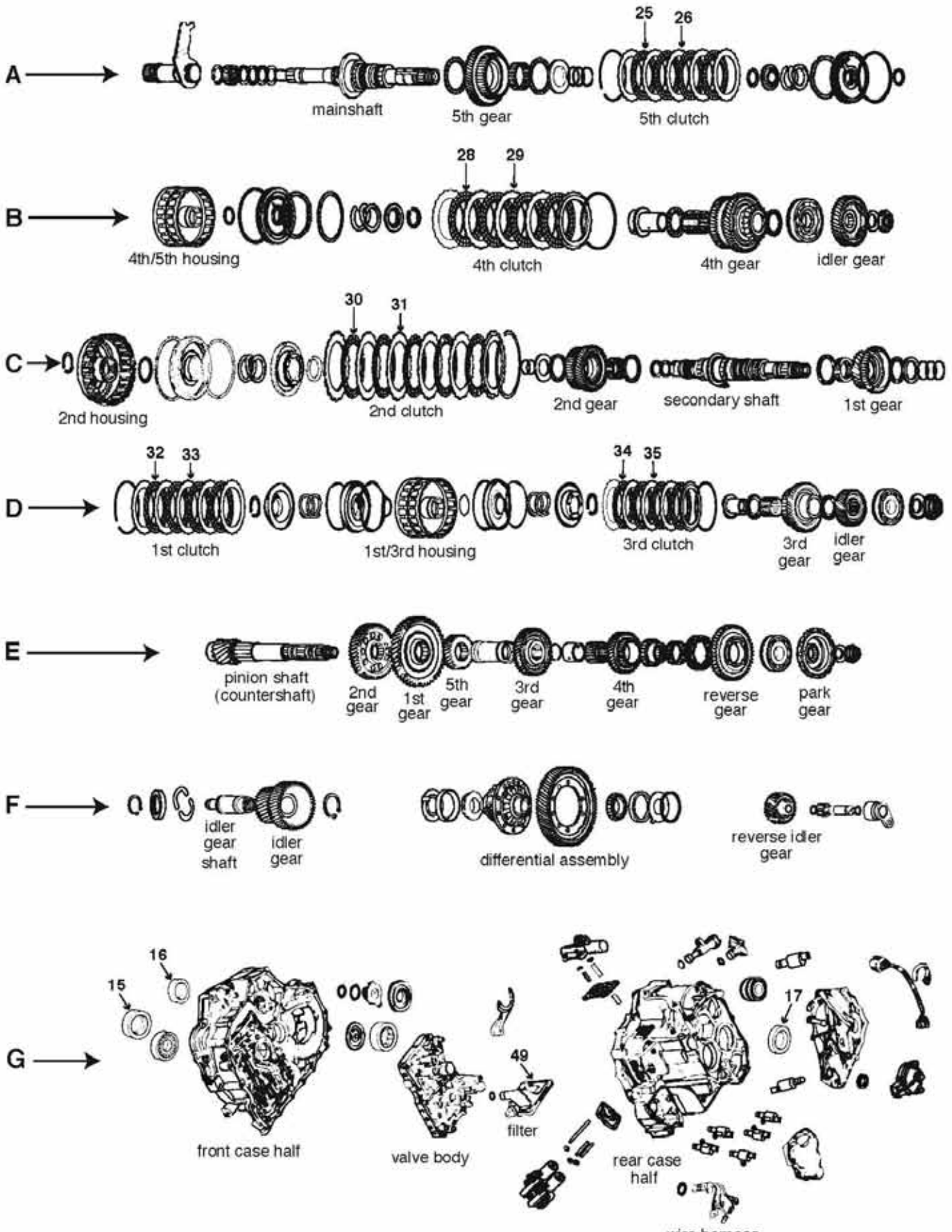

MKYA/BZHA/BZJA
60198-

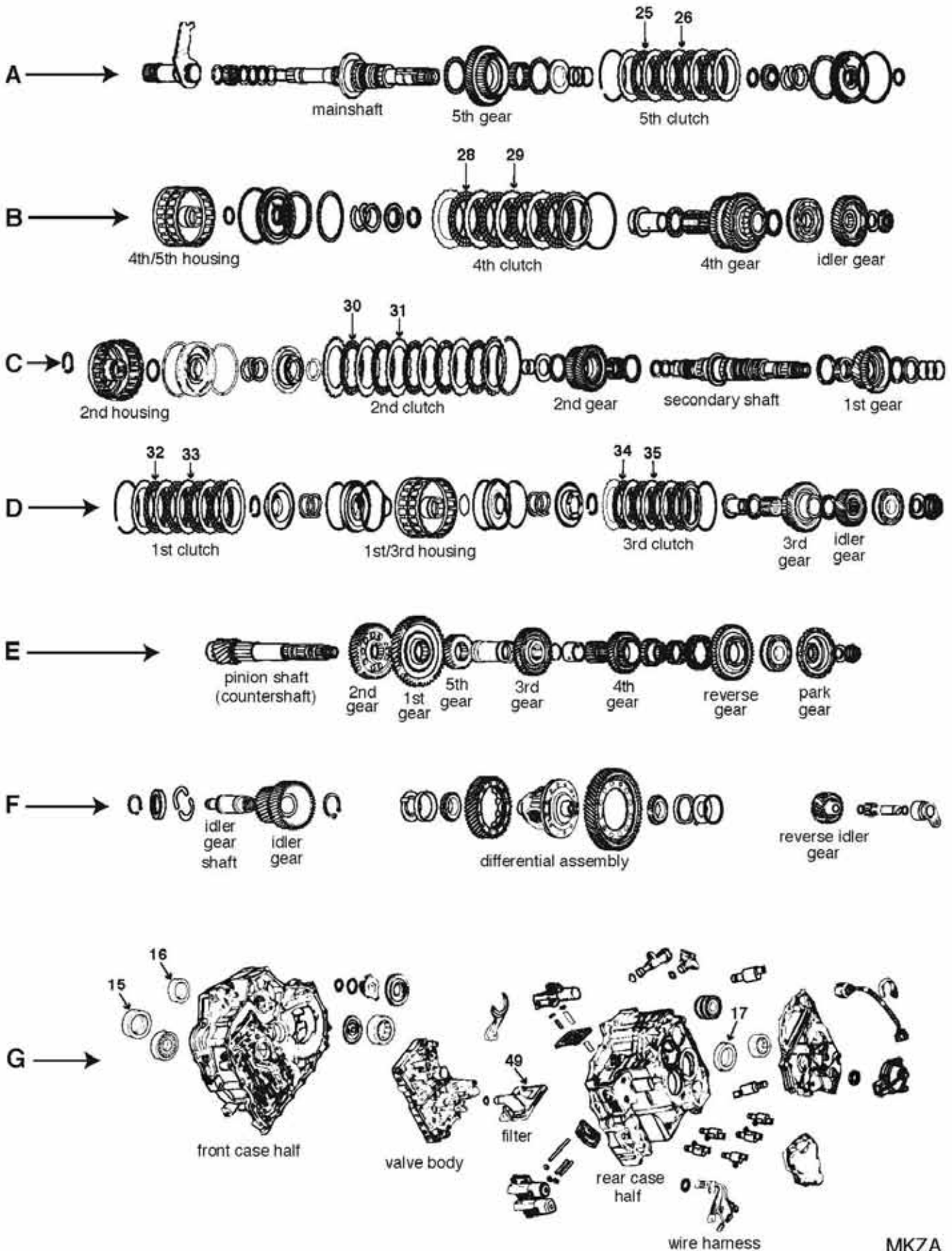

MKZA
60199-

ILL	DESCRIPTION		QTY	YEAR	REFERENCE #	PART #
REBUILDER KITS						
K5	Master kit w/steels	MKZA	1	05-06	K4800ZV	60197-11104
K6	Master kit w/o steels	MKZA	1	05-06	K4800ZV-W/O	60197-12104
K7	O/H gasket set w/o seals-rings	MKZA	1	05-06	FDB-2430	25175-13104
METAL CLAD SEALS						
G15	Seal, metal clad 44x68x8mm	converter housing	1	05-06	91206-P0Z-005	50201A
G16	Seal, metal clad	right axle	1	05-06	91206-PHR-003	60211-30300
G17	Seal, metal clad 40x56x9mm	left axle	1	05-06	91205-P0X-005	50210
CLUTCH PLATES						
A25	Friction .077" 4.846" od 44T	5th clutch	4	05-06	22546-RFK-003	50131
A26	Steel .079" 6T	5th clutch	4	05-06	169701A-200	60195-37604
B28	Friction .077" 4.846" od 44T	4th clutch	4	05-06	22546-RFK-003	50131
B29	Steel .079" 6T	4th clutch	4	05-06	169701A-200	60195-37604
C30	Friction .076" 4.728" od 44T	2nd clutch	5	05-06	22544-PRP-003	50105
C31	Steel .079" 3.664" id 24T	2nd clutch	4	05-06	078701	50110
C31	Steel .057" 3.677" id 24T	2nd clutch	1	05-06	078701-400	60195-37504
D32	Friction .076" 4.728" od 44T	1st clutch	5	05-06	22544-PRP-003	50105
D33	Steel .063" 3.664" id 24T	1st clutch	5	05-06	078701-160	50140
D34	Friction .077" 4.665".od 42T	3rd clutch	5	05-06	22545-RCR-003	60197-35104
D35	Steel .063" 3.664" id 24T	3rd clutch	5	05-06	078701-160	50140
FILTERS						
G49	Filter, oil screen	MKZA	1	05-06	25420-PRP-003	25175-45004
NOTES						

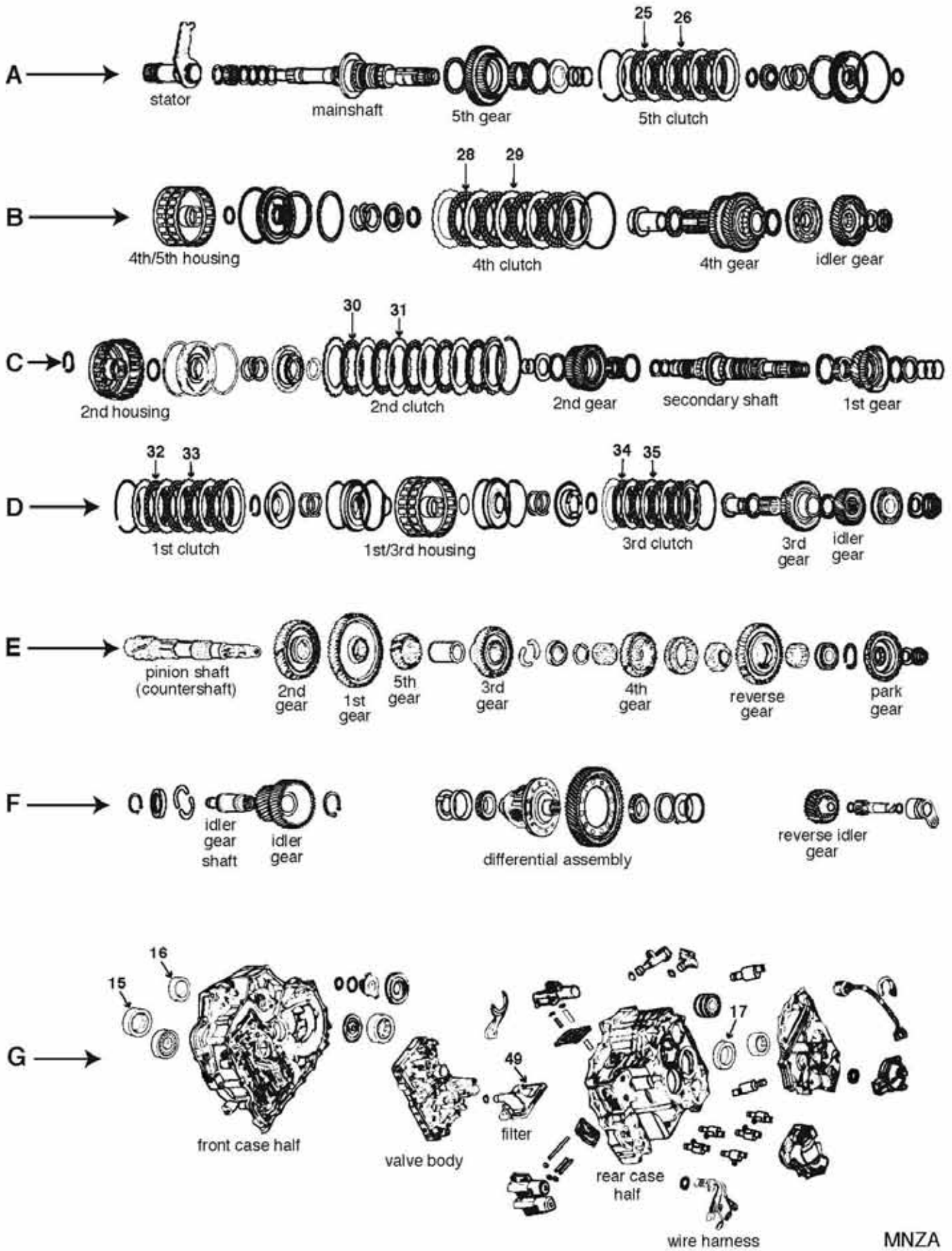

MNZA
60201-

ILL	DESCRIPTION	QTY	YEAR	REFERENCE #	PART #
REBUILDER KITS					
K5	Master kit w/steels MNZA	1	07-10	n/a	60201-11104
K6	Master kit w/o steels MNZA	1	07-10	n/a	60201-12104
K7	O/H gasket set w/seals-rings MNZA	1	07-10	n/a	60201-13104
FILTERS					
G49	Filter MNZA	1	07-10	n/a	60201-45004
NOTES					

MNZA

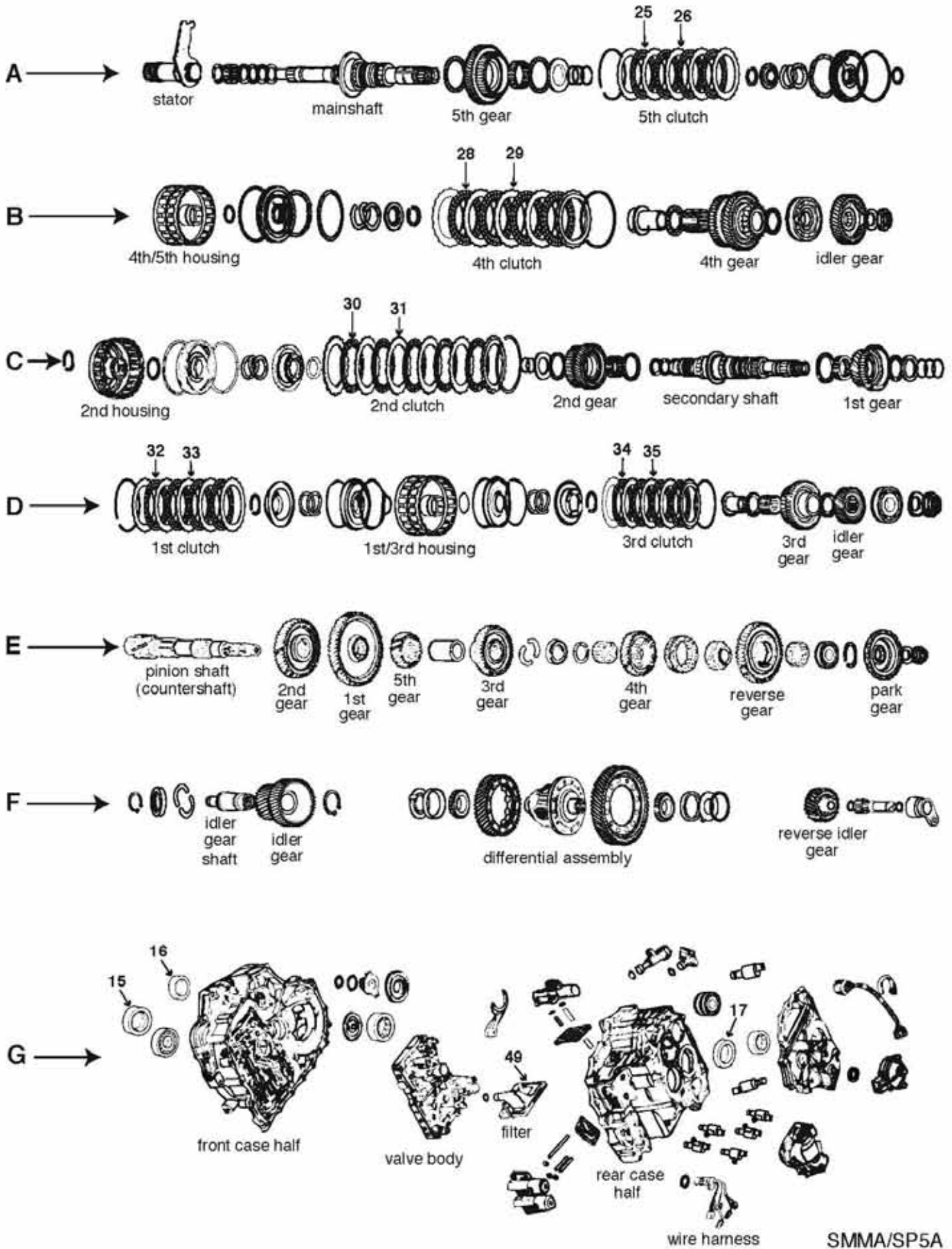

SMMA/SP5A
60211-

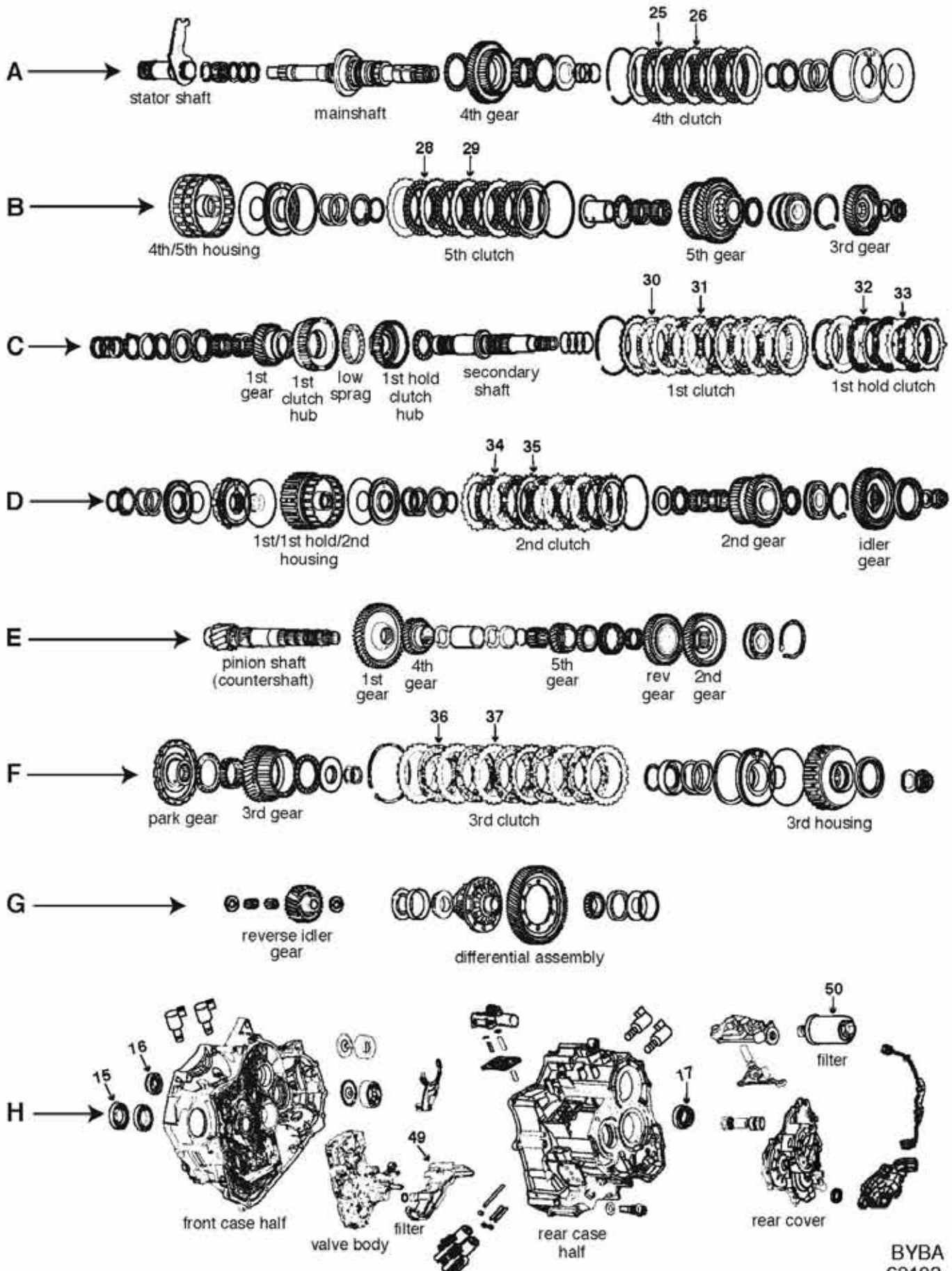

BYBA
60193-

ILL	DESCRIPTION			QTY	YEAR	REFERENCE #	PART #
REBUILDER KITS							
K5	Master kit w/steels BYBA			1	02-07	157901	25165-11104
K6	Master kit w/o steels BYBA			1	02-07	157901LS	25165-12104
K7	O/H gasket set w/seals-rings BYBA			1	02-07	FDB-2406	25165-13104
METAL CLAD SEALS							
H16	Seal, metal clad 44x68x8mm converter housing			1	02-04	91206-P0Z-005	50201A
H15	Seal, metal clad 35x54x8mm right axle			1	00-04	91207-P7Z-003	50228
H17	Seal, metal clad 40x56x9mm left axle			1	02-04	91205-P0X-005	50210
CLUTCH PLATES							
A25	Friction .077" 5.043" od 44T 4th clutch			4	02-04	134702-195	50135
A26	Steel .078" 3.664" id 20T (narrow teeth) 4th clutch			4	02-04	134703-200	50138
B28	Friction .077" 5.043" od 44T 5th clutch			4	02-04	134702-195	50135
B29	Steel .091" 3.664" id 20T 5th clutch			4	02-04	134703-230	50136
C30	Friction .076" 5.190" od 49T 1st low			5	02-04	116702	50141
C31	Steel .063" 4.070" id 24T 1st low			5	02-04	146701-160	25171-37504
C32	Friction .076" 4.728" od 44T low-hold			3	02-04	078700G	50105
C33	Steel .071" 3.677" id 6T low-hold			3	02-04	146703-180	25171-37704
D34	Friction .077" 5.020" od 30T 2nd clutch			6	02-04	146704-195	25167-35104
D35	Steel .079" 5.020" id 20T (waved) 2nd clutch			6	02-04	146705-160	25175-37604
F36	Friction .077" 4.890" od 42T 3rd clutch			5	02-04	22644-PGH-003	25165-35404
F37	Steel .091" 3.463" id 20T 3rd clutch			5	02-04	22653-PHG-003	25165-37504
FILTERS							
H49	Filter, oil screen (internal) BYBA			1	02-07	25450-P7W-003	50800R
H50	Filter, external spin on BYBA			1	02-04	25450-P7W-003	25171-45104
n/i	Filter, cooler line (cartridge type) BYBA			1	03-07	25450-P4V-013	60193-45104
SNAP RINGS							
n/i	Snap ring 3rd gear spring retainer			1	02-04	90603-PL4-000	25165-64104
HARD PARTS							
n/i	Retainer, spring 3rd gear			1	02-04	22654-P7W-003	25165-78904
n/i	Spring, clutch return 3rd gear			1	02-04	22652-P7W-003	25165-79104
ELECTRICAL COMPONENTS							
n/i	Switch, pressure (black connector) 33 PSI (threaded/stepped)			1	02-04	28600-P7Z-003	15A-161
n/i	Switch, pressure (beige connector) 27 PSI (threaded/stepped)			1	02-04	28600-P7W-003	15A-162
NOTES							

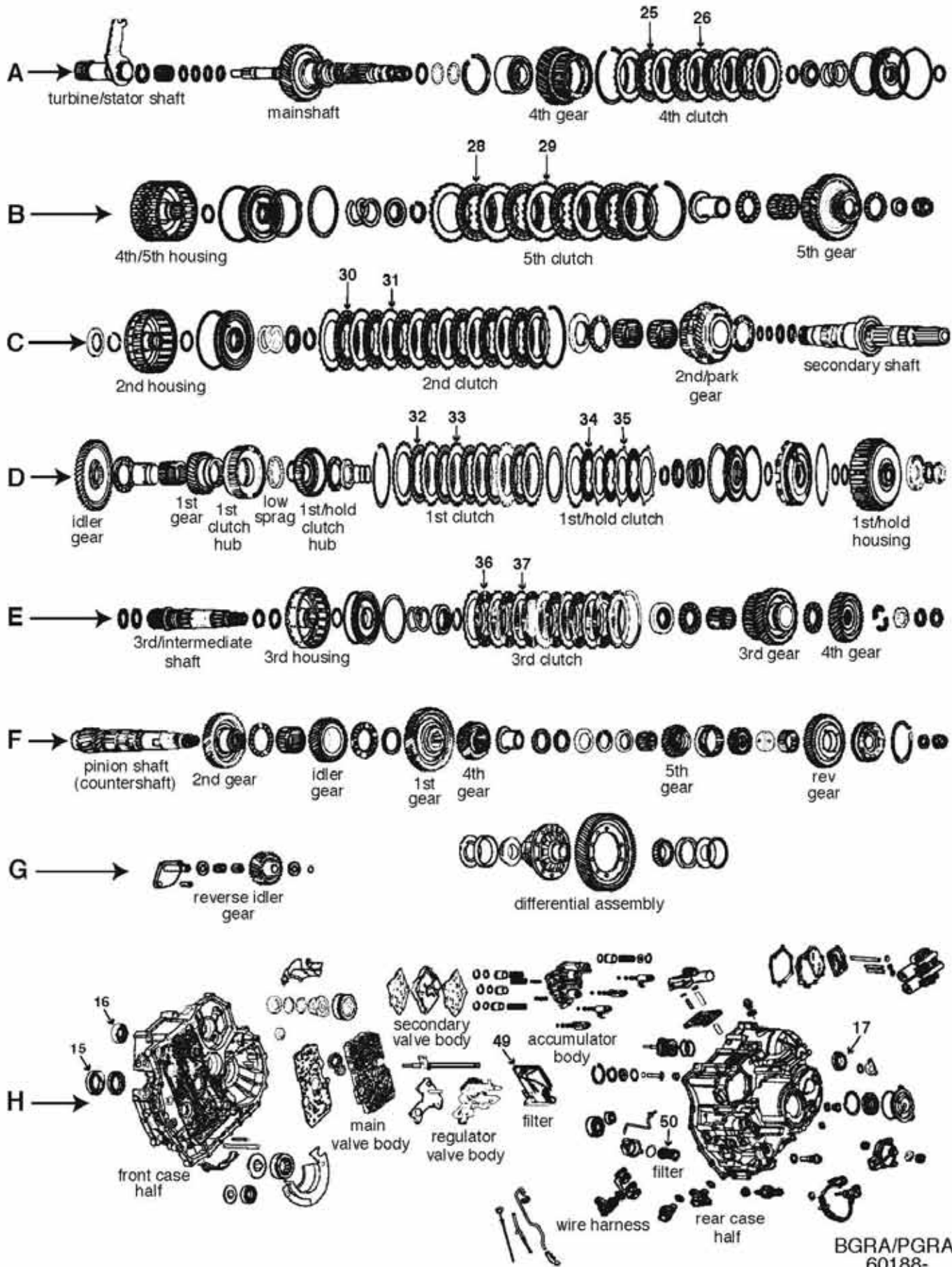

BGRA/PGRA
60188-

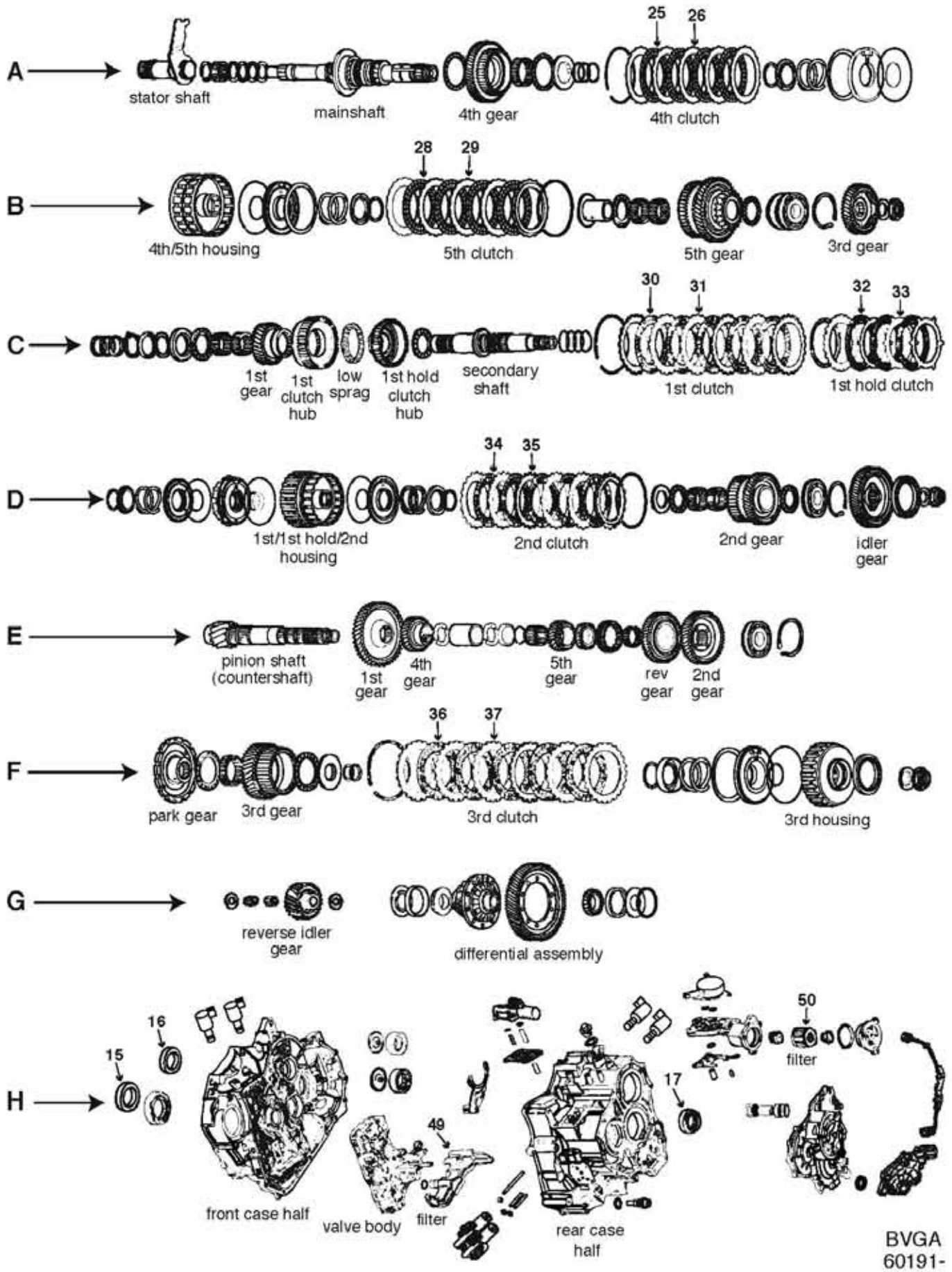

BVGA
60191-

ILL	DESCRIPTION		QTY	YEAR	REFERENCE #	PART #
REBUILDER KITS						
K5	Master kit w/steels	BVGA	1	03-07	K4800LL	60191-11104
K6	Master kit w/o steels	BVGA	1	03-07	K4800LL-W/O	60191-12104
K7	O/H gasket set w/seals-rings	BVGA	1	03-07	2406	25165-13104
METAL CLAD SEALS						
H15	Seal, metal clad 44x68x8mm	converter housing	1	03-07	91206-P0Z-005	50201A
H16	Seal, metal clad 35x54x8mm	right axle	1	03-07	91207-P7Z-003	50228
H17	Seal, metal clad 40x56x9mm	left axle	1	03-07	91205-P0Z-005	50210
CLUTCH PLATES						
A25	Friction .077" 5.043" od 44T	4th clutch	4	03-07	22644-P7T-003	50135
A26	Steel .091" 3.664" id 20T	4th clutch	4	03-07	22656-P7T-003	50136
B28	Friction .075" 4.570" od 44T	5th clutch	4	03-07	22644-P7T-003	50139
B29	Steel .078" 3.664" id 20T (narrow teeth)	5th clutch	4	03-07	22653-P7T-003	50138
C30	Friction .076" 5.190" od 49T	1st low clutch	5	03-07	22544-P7W-003	50141
C31	Steel .063" 4.070" id 24T	1st low clutch	5	03-07	22543-P7W-003	25171-37504
C32	Friction 0.091" 4.728" od 44T	low-hold clutch	3	03-07	22544-PX4-701	50127
C33	Steel .071" 3.677" id 6T	low-hold clutch	3	03-07	22673--P7W-003	25171-37704
D34	Friction .077" 5.020" od 30T	2nd clutch	6	03-07	22545-PGH-A01	25167-35104
D35	Steel .063" 3.751" id 20T	2nd clutch	6	03-07	22643-P7W-003	25171-37604
F36	Friction .077" 4.890" od 42T	3rd clutch	5	03-07	22644-PGH-003	25165-35404
F37	Steel .091" 3.463" id 20T	3rd clutch	5	03-07	22653-PGH-003	25165-37504
FILTERS						
H49	Filter, oil screen (internal)	BVGA	1	03-07	25420-P7W-003	50800R
H49	Filter, oil screen	BVGA	1	06-07	25420-PHG-003	60191-45004
H50	Filter, cooler line (cartridge type)	BVGA	1	03-07	25450-P4V-013	50711
ELECTRICAL COMPONENTS						
n/i	Switch, pressure (black connector)	33 PSI (threaded stepped)	1	03-07	28600-P7Z-003	15A-161
n/i	Switch, pressure (beige connector)	27 PSI (threaded stepped)	1	03-07	28600-P7W-003	15A-162
NOTES						

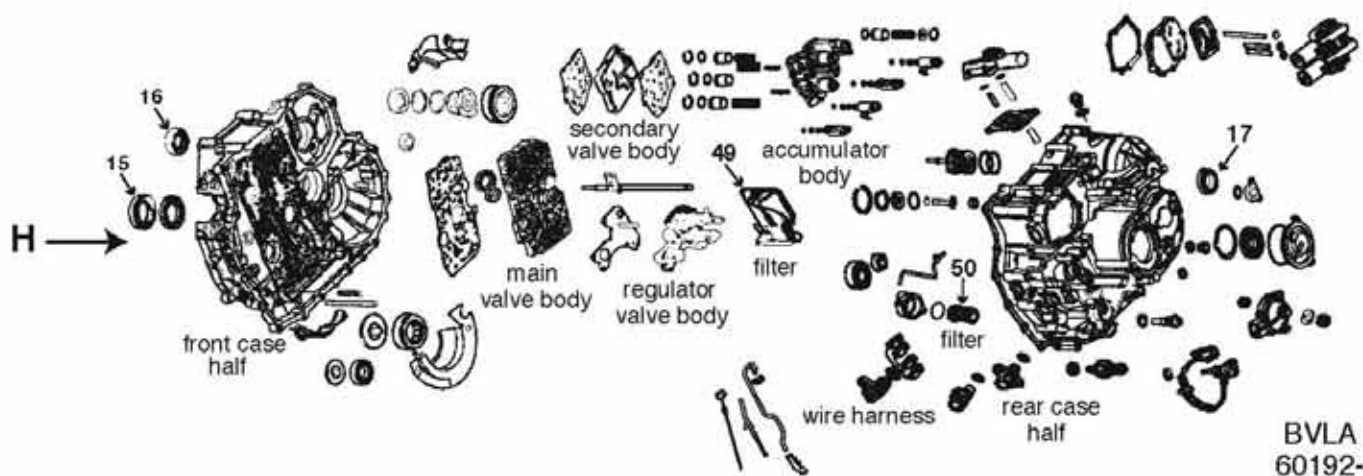
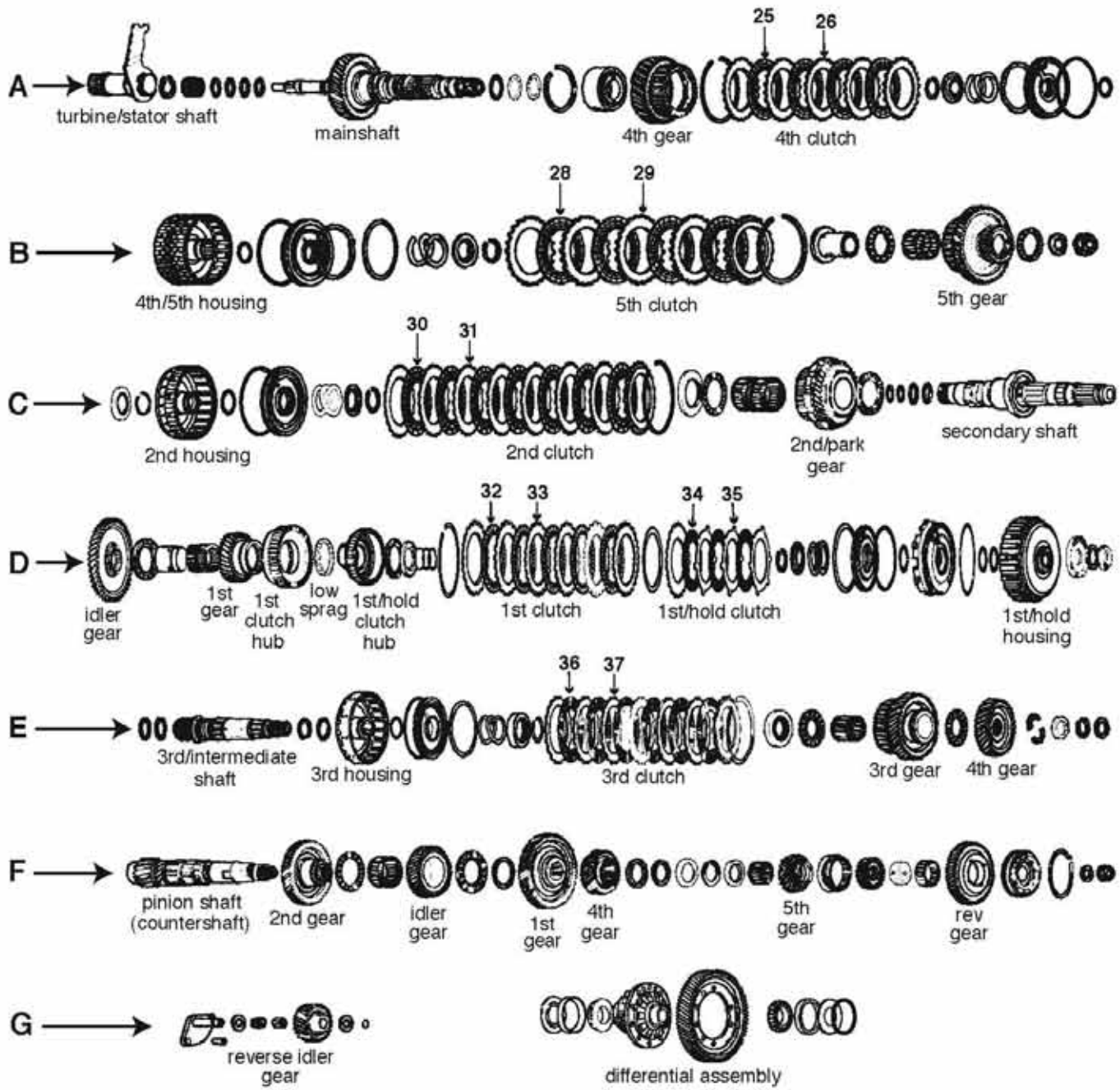

BVLA
60192-

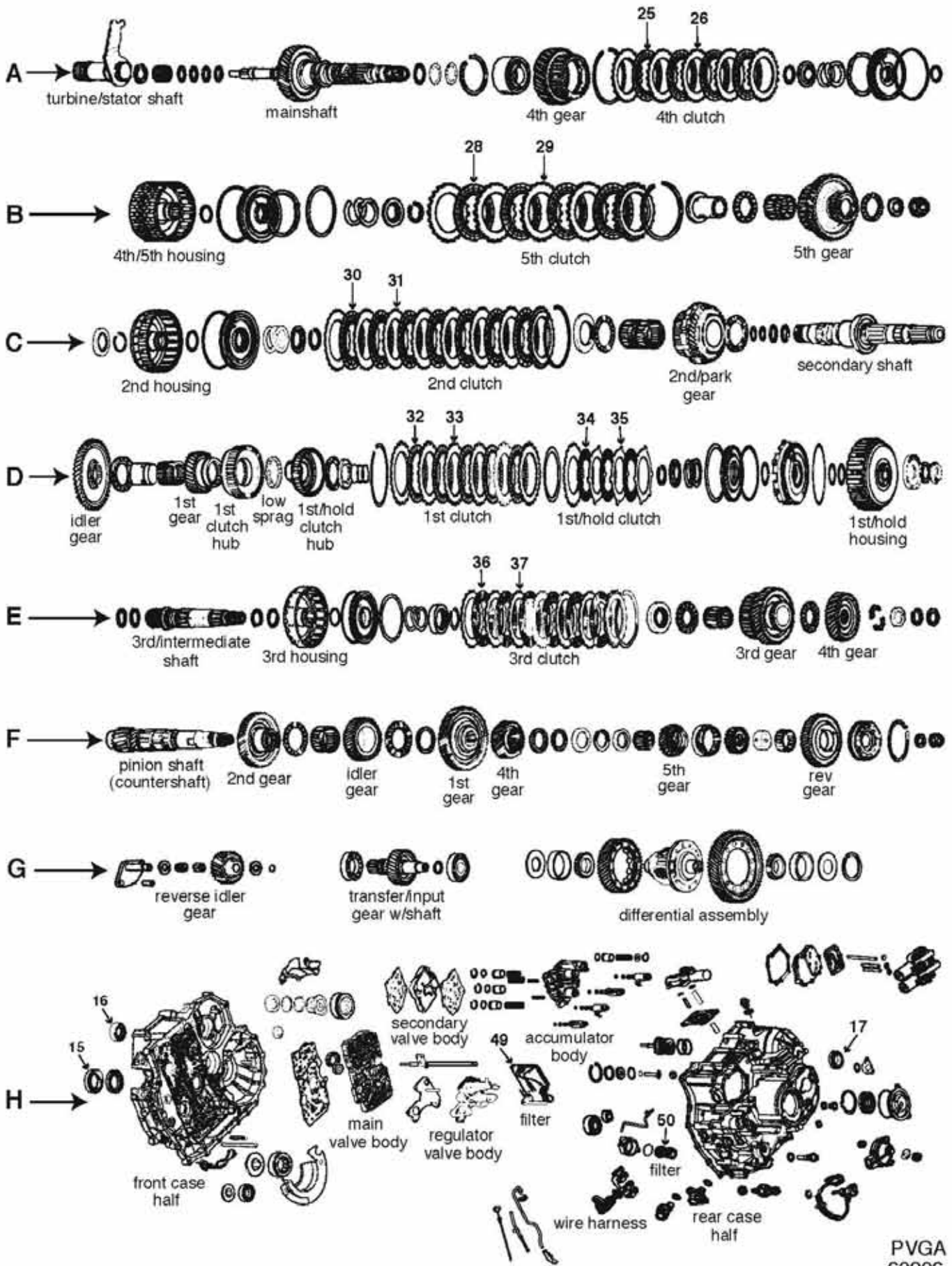

PVGA
60206-

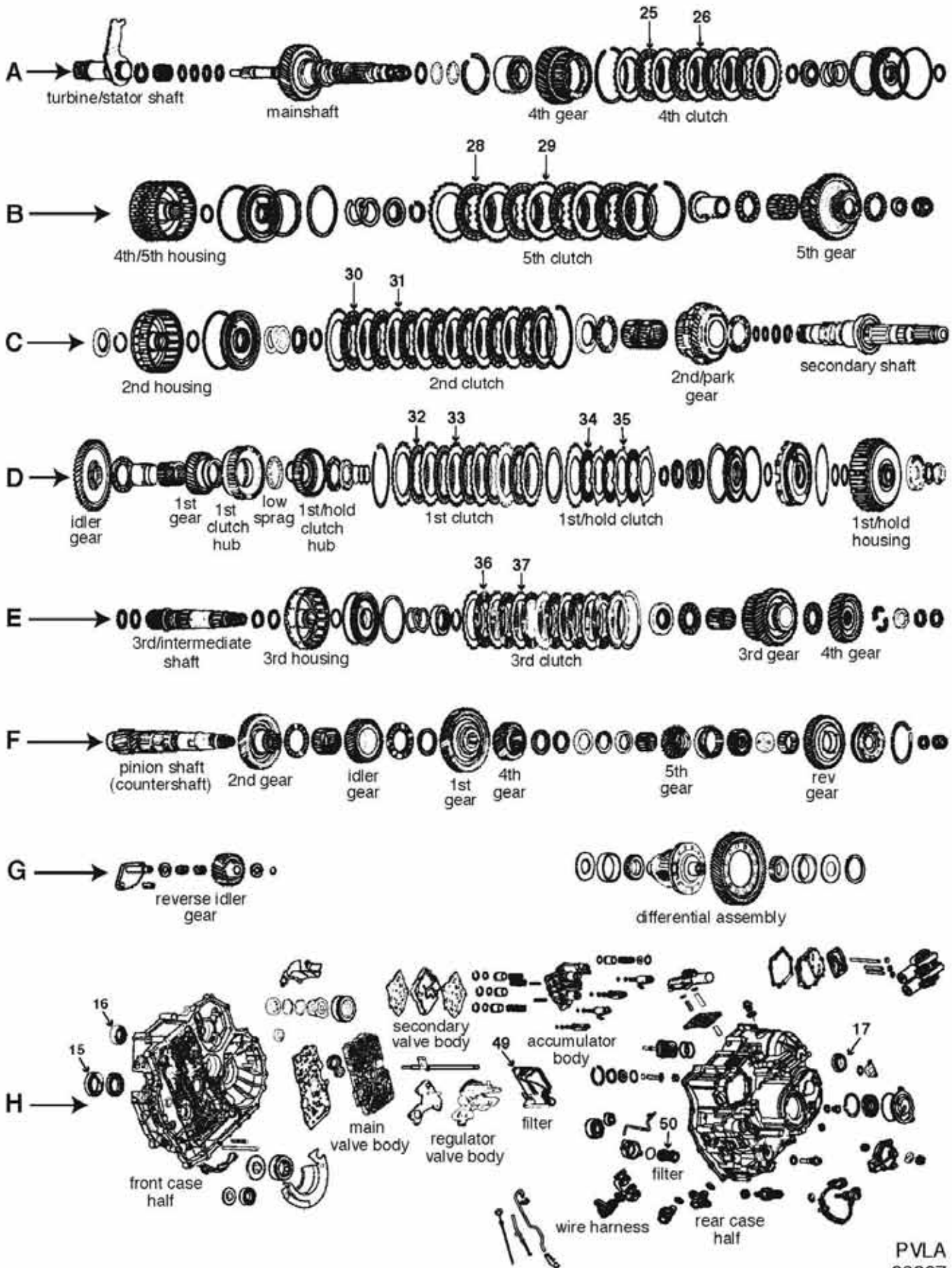

PVLA
60207-

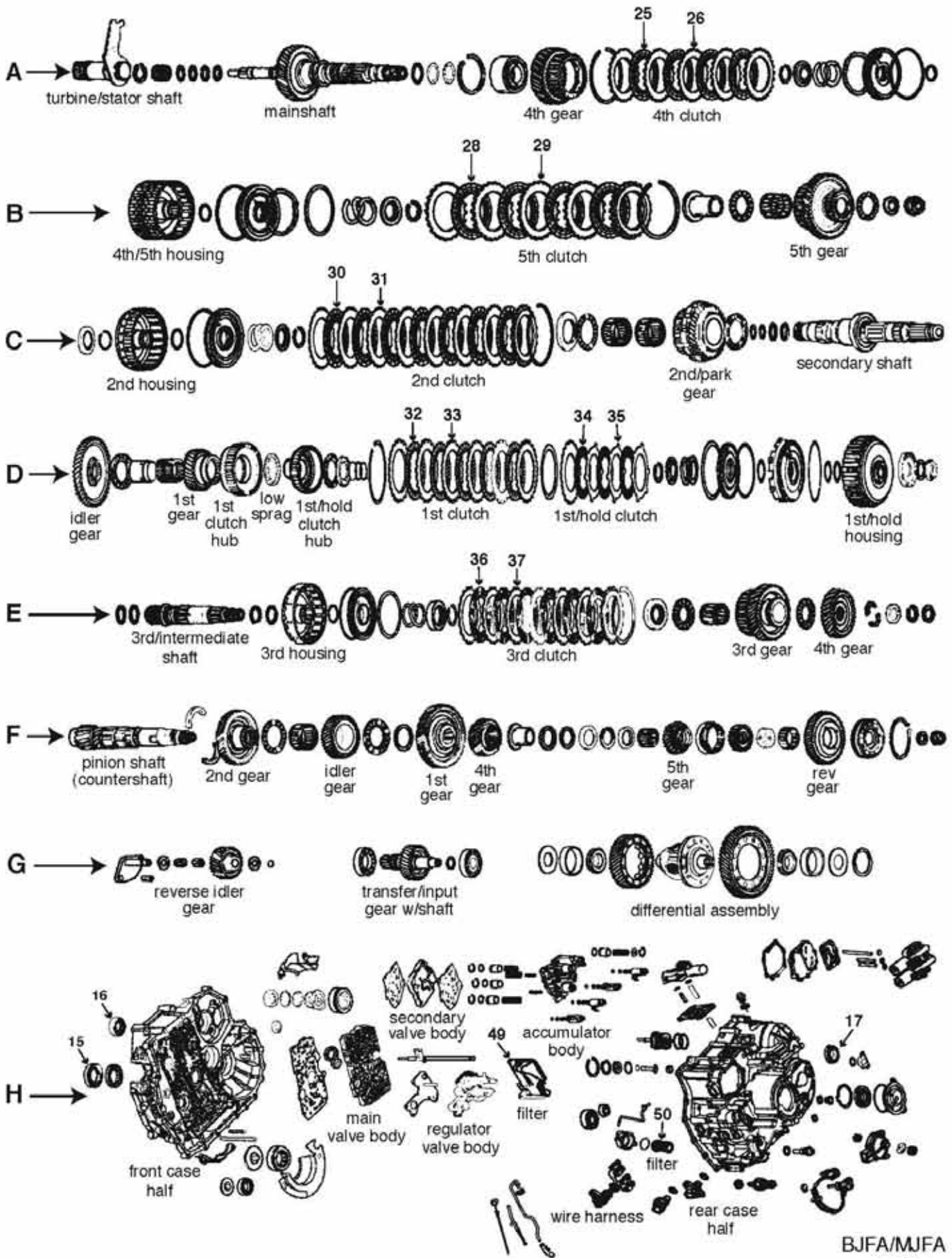

BJFA/MJFA
60189-

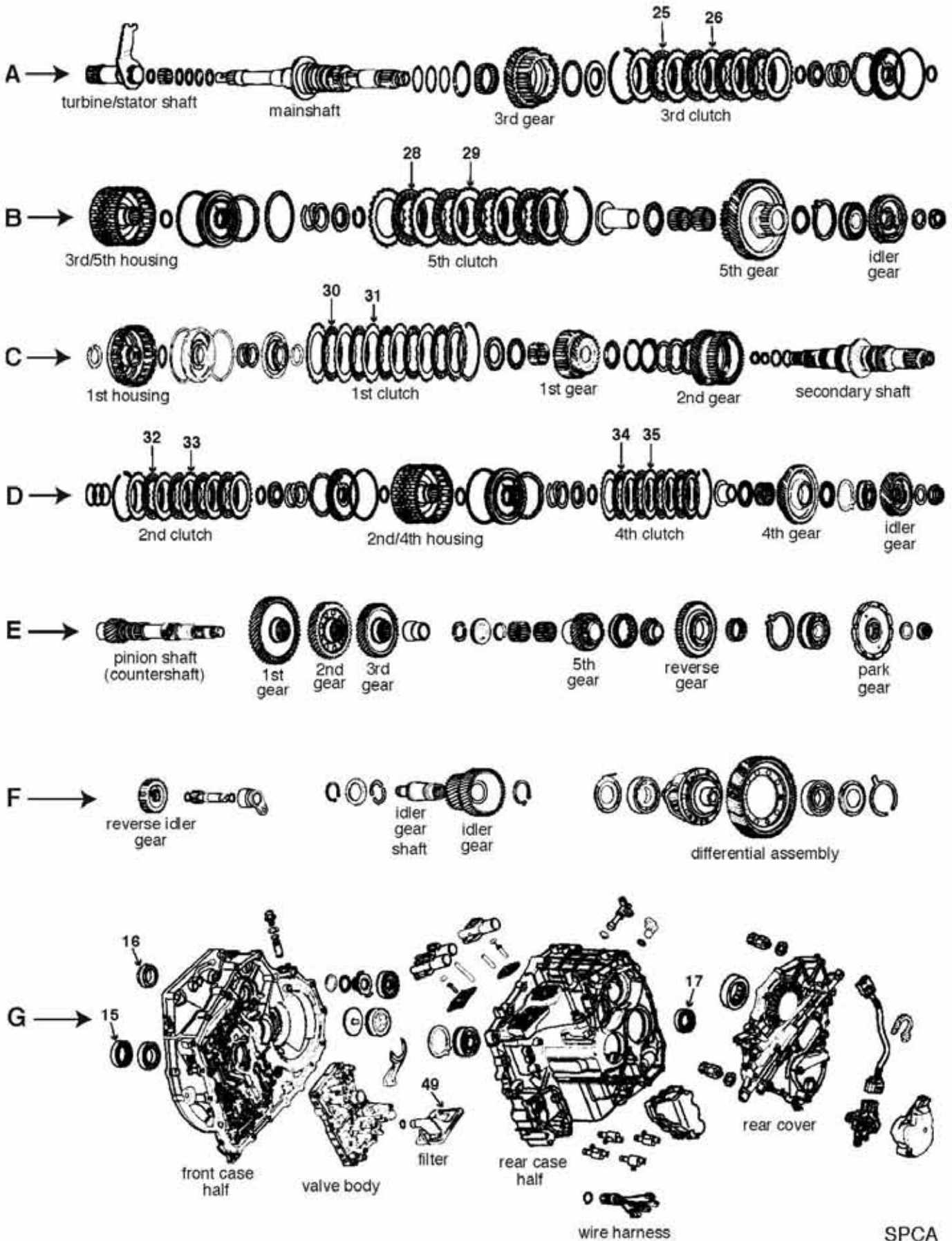

SPCA
60208-

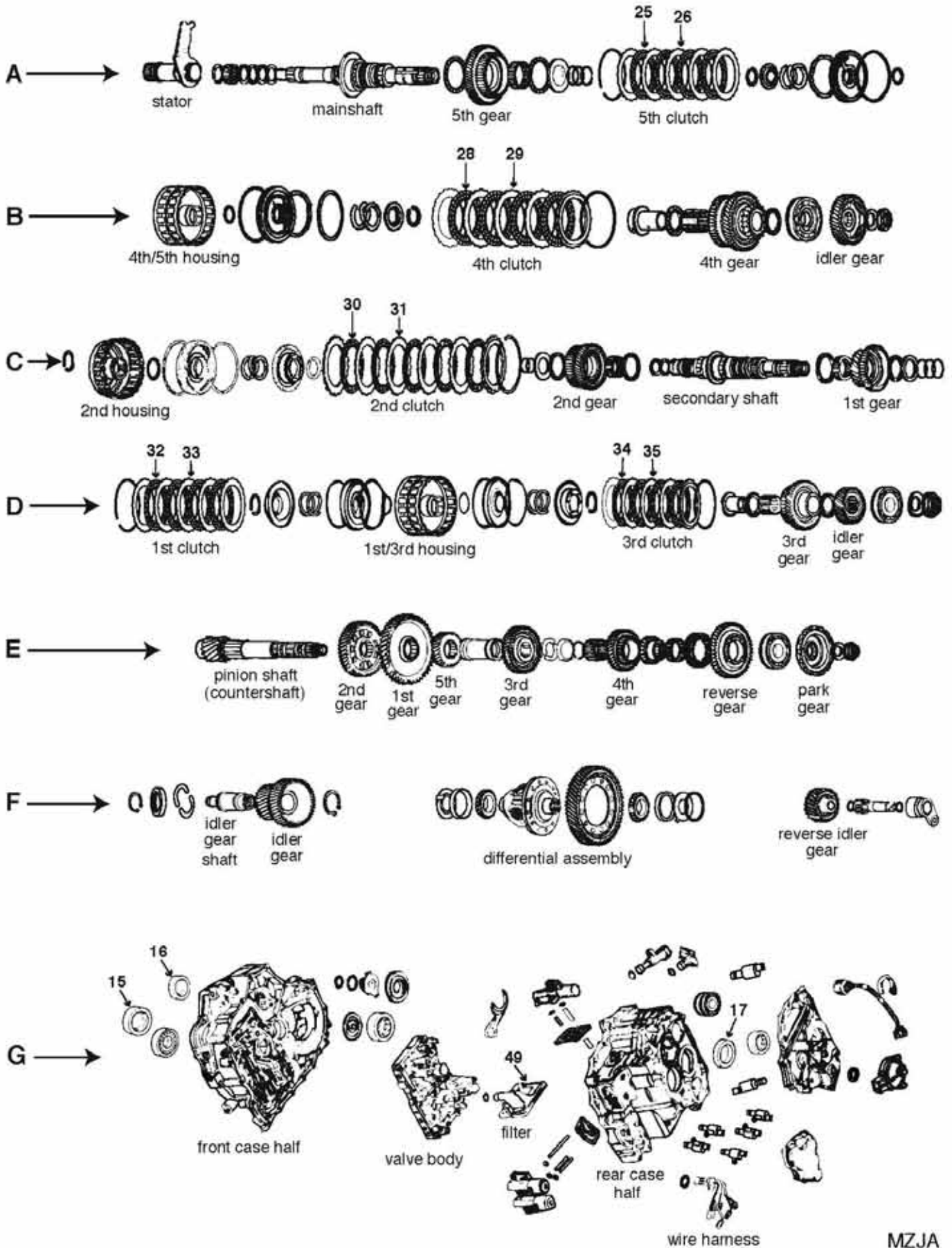

MZJA
60205-

ILL	DESCRIPTION		QTY	YEAR	REFERENCE #	PART #
REBUILDER KITS						
K5	Master kit w/steels	MZJA	1	07-10	AE	60205-11104
K6	Master kit w/o steels	MZJA	1	07-10	AE	60205-12104
K7	O/H gasket set w/o seals-rings	MZJA	1	07-10	FDB-2430	25175-13104
METAL CLAD SEALS						
G15	Seal, metal clad 44x68x8mm	converter housing	1	07-10	91206-P0Z-005	50201A
G16	Seal, metal clad	right axle	1	07-10	91206-PHR-003	60211-30300
G17	Seal, metal clad 35x56x8mm	left axle	1	07-10	91205-PL3-A01	50211
FILTERS						
G49	Filter	MZJA	1	07-10	n/a	60205-45004
NOTES						

MZJA

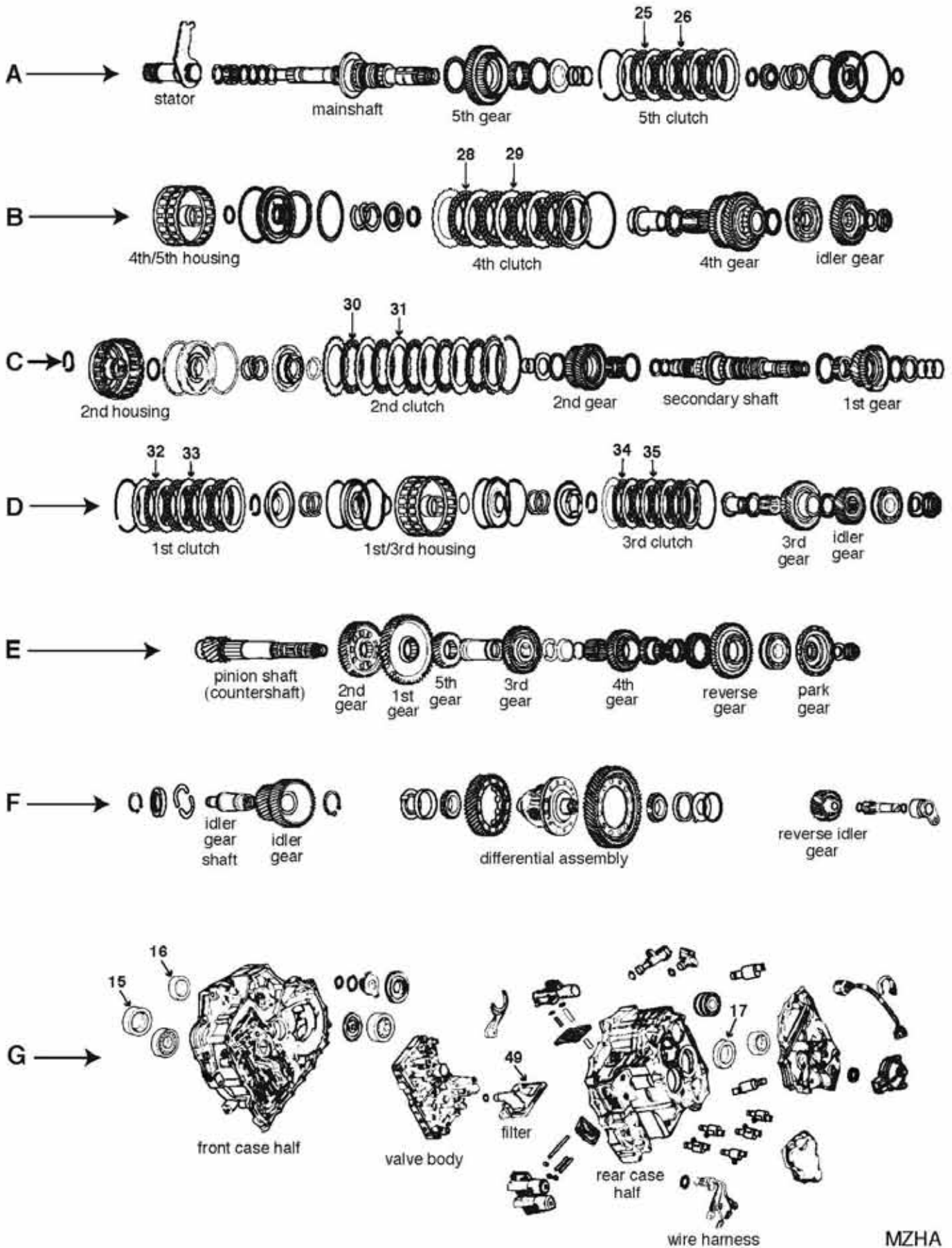

MZHA
60204-

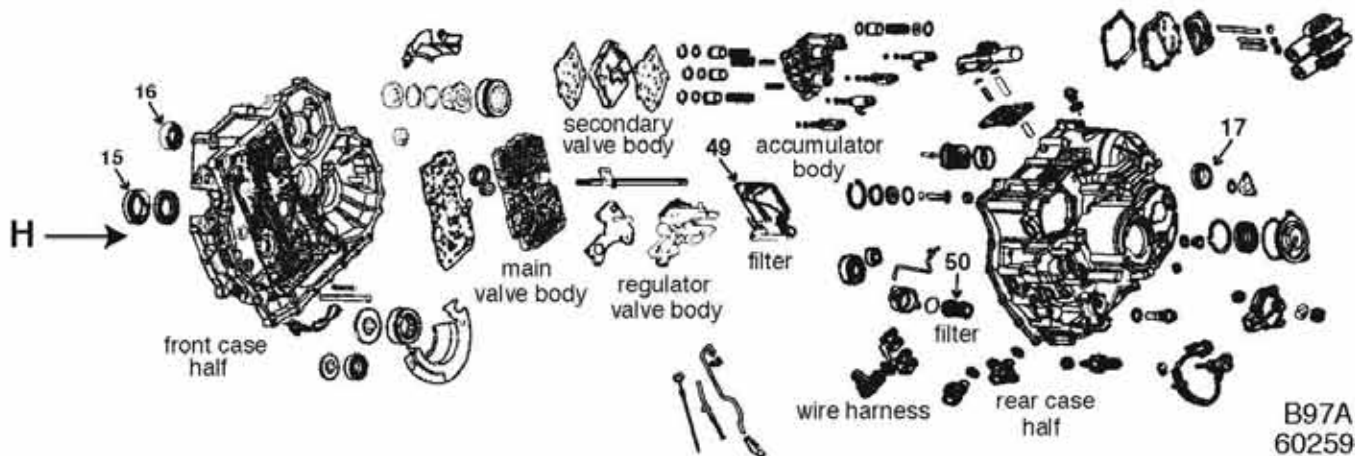
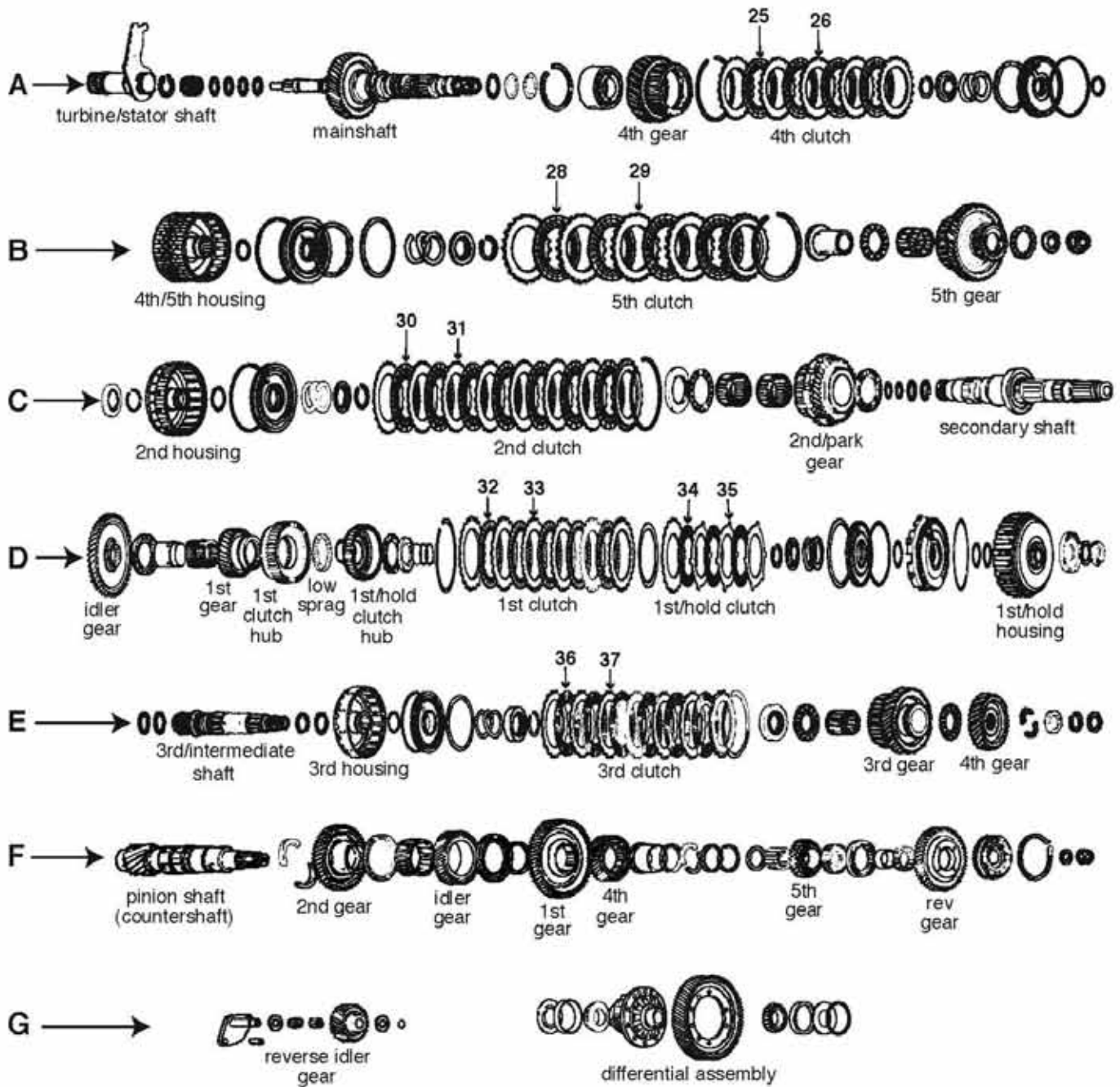

B97A
60259-

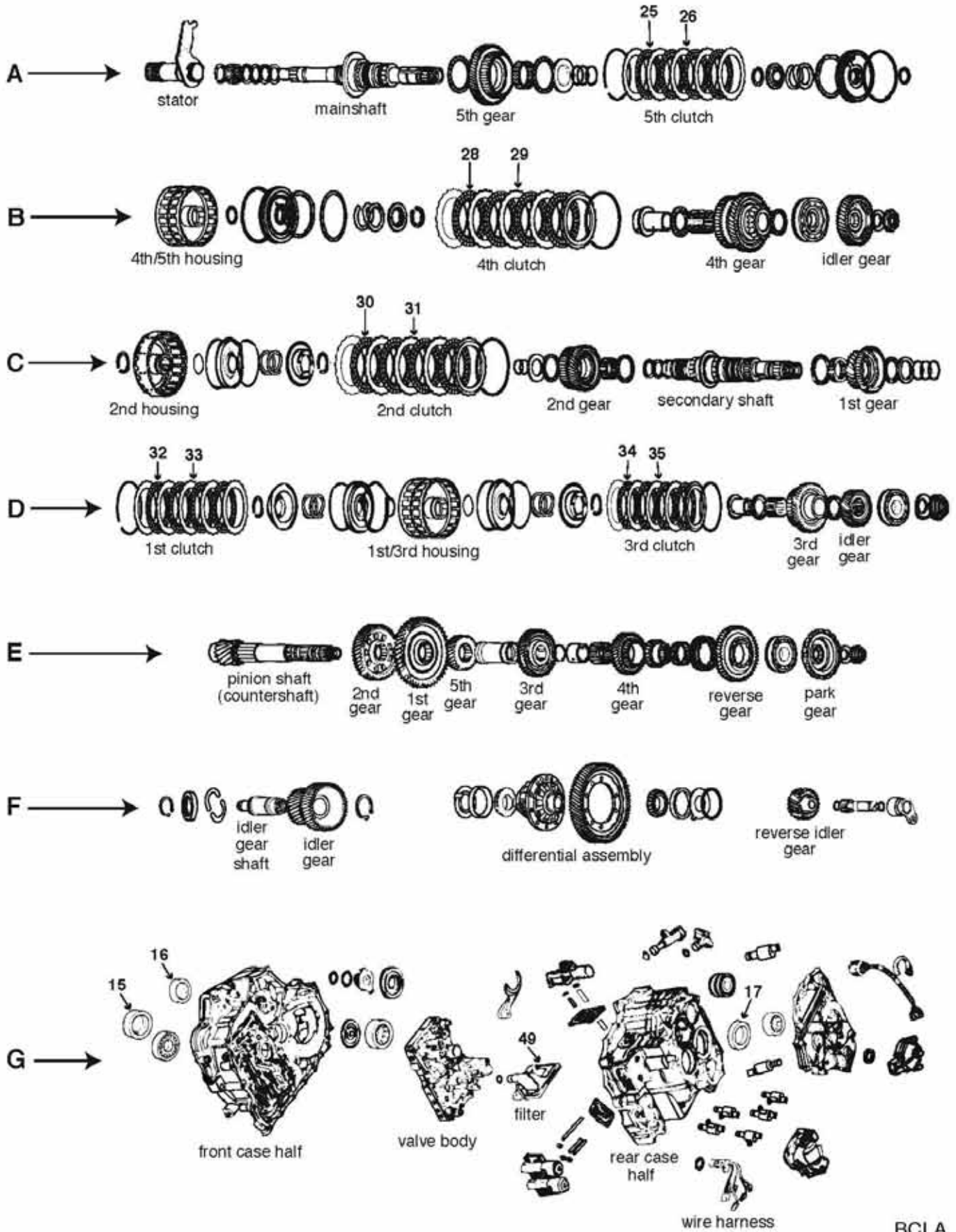

BCLA
60190-

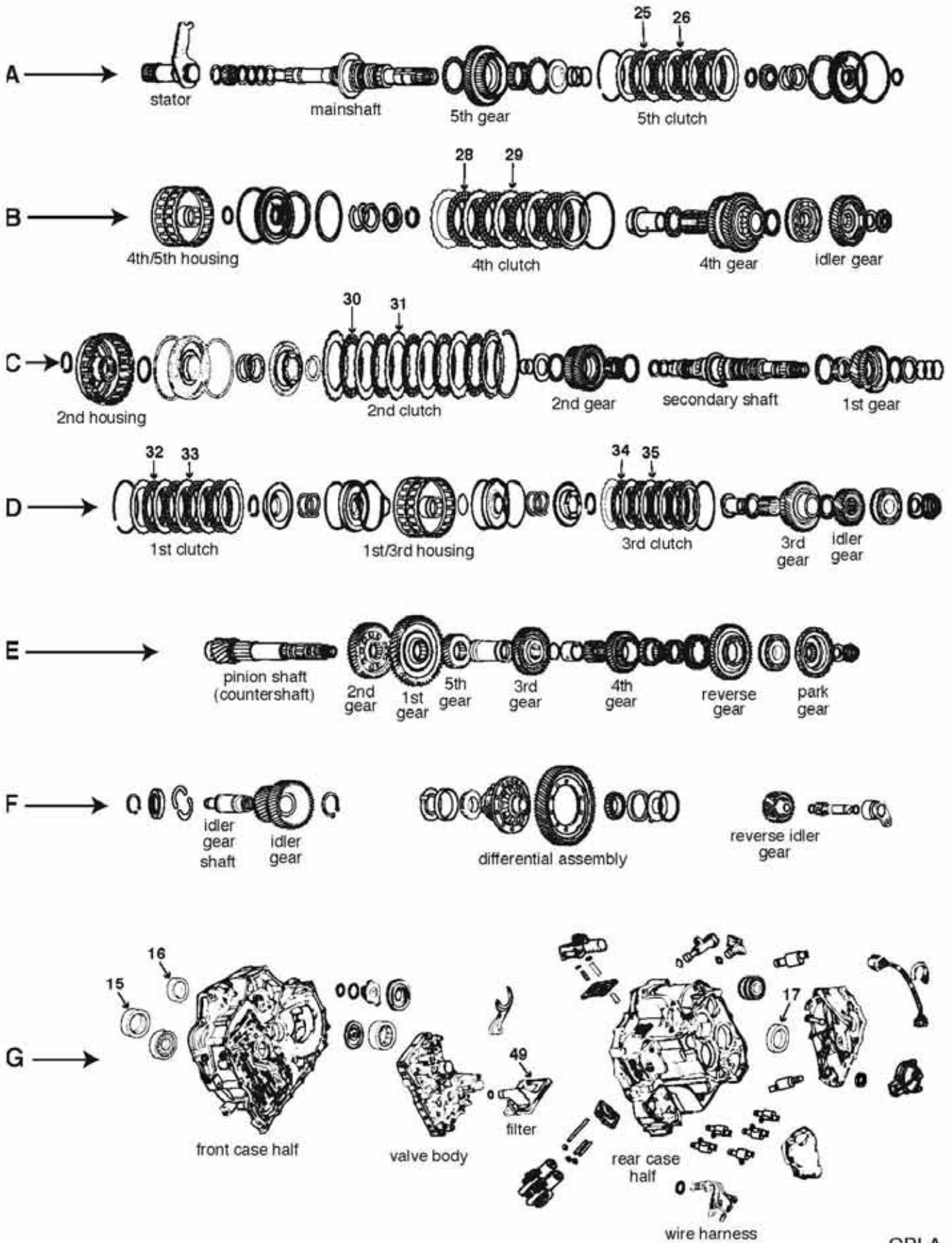

GPLA
60194-

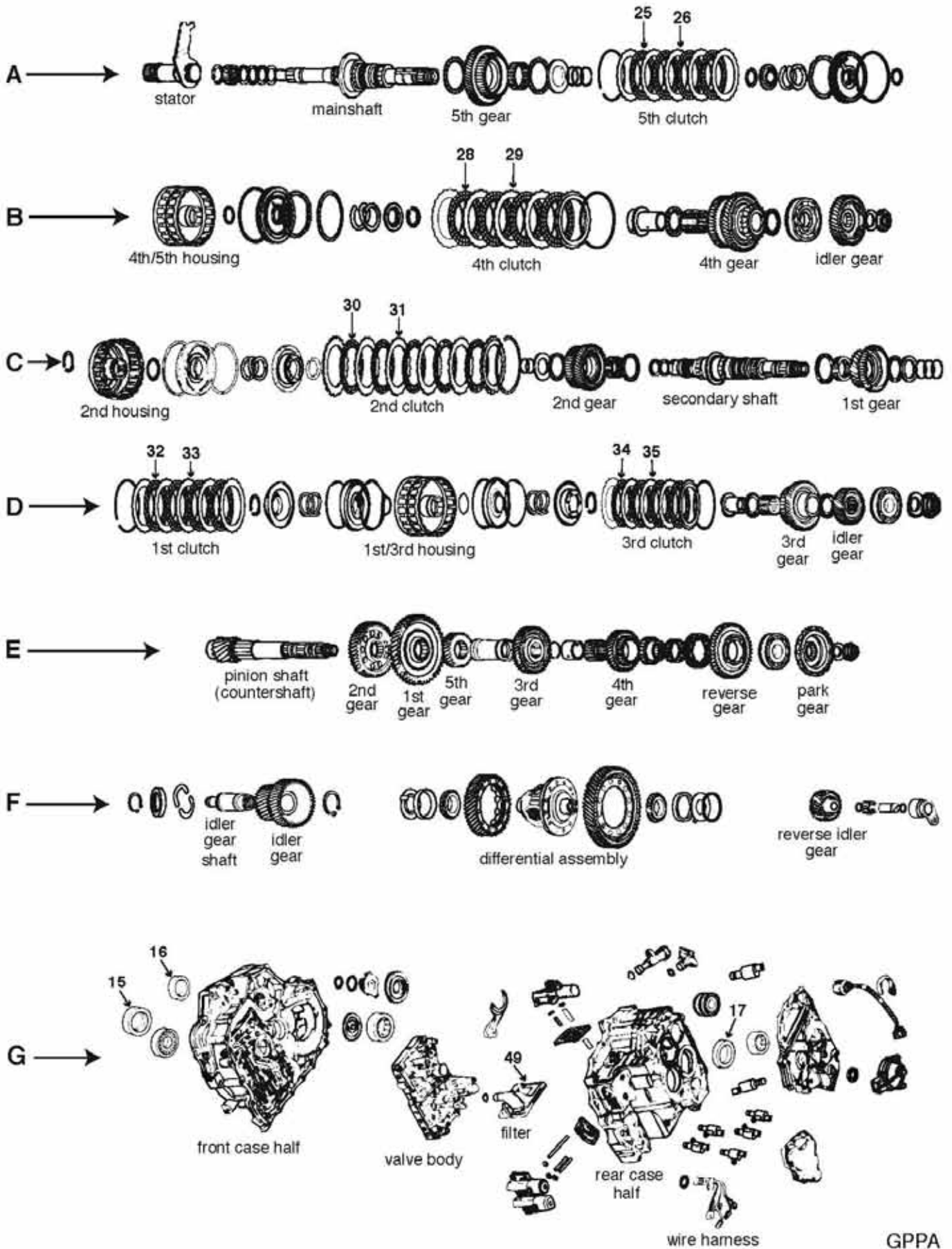

GPPA
60195-

ILL	DESCRIPTION		QTY	YEAR	REFERENCE #	PART #
REBUILDER KITS						
K5	Master kit w/steels	GPPA	1	05-07	169901A	60195-11104
K6	Master kit w/o steels	GPPA	1	05-07	169901ALS	60195-12104
K7	O/H gasket set w/o seals-rings	GPPA	1	05-07	FDB-2430	25175-13104
METAL CLAD SEALS						
G15	Seal, metal clad 44x68x8mm	converter housing	1	05-07	91206-P0Z-005	50201A
G16	Seal, metal clad	right axle	1	05-07	B29282	60211-30300
G17	Seal, metal clad 40x56x9mm	left axle	1	05-07	91205-P0X-005	50210
CLUTCH PLATES						
A25	Friction .077" 4.846" od 44T	5th clutch	4	05-07	22546-RFK-003	50131
A26	Steel .079" 6T	5th clutch	4	05-07	22653-PRP-901	60195-37604
B28	Friction .077" 4.846" od 44T	4th clutch	4	05-07	22546-RFK-003	50131
B29	Steel .079" 6T	4th clutch	4	05-07	22653-PRP-901	60195-37604
C30	Friction .076" 4.728" od 44T	2nd clutch	5	05-07	22544-PRP-003	50105
C31	Steel .079" 3.664" id 24T	2nd clutch	4	05-07	22643-RCL-003	50110
C31	Steel .057" 3.677" id 24T	2nd clutch	1	05-07	22643-RCL-801	60195-37504
D32	Friction .076" 4.728" od 44T	1st clutch	5	05-07	22544-PRP-003	50105
D33	Steel .063" 3.664" id 24T	1st clutch	5	05-07	22543-RCL-901	50140
D34	Friction .077" 4.665" od 42T	3rd clutch	5	05-07	22545-RCR-003	60197-35104
D35	Steel .063" 3.664" id 24T	3rd clutch	5	05-07	22543-RCL-901	50140
FILTERS						
G49	Filter, oil screen	GPPA	1	05-07	25420-PRP-003	25175-45004
NOTES						

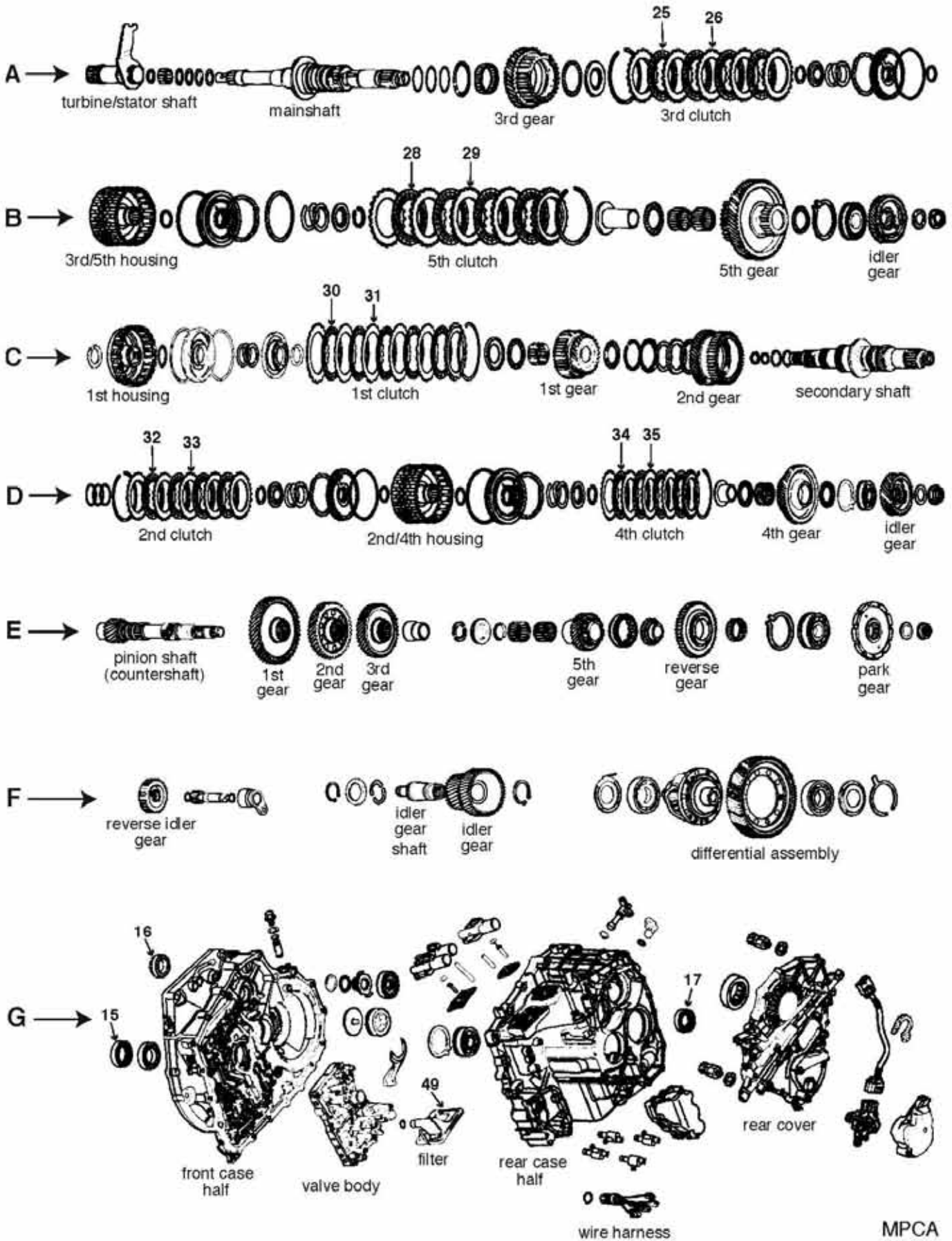

MPCA
60202-

ILL	DESCRIPTION	QTY	YEAR	REFERENCE #	PART #
REBUILDER KITS					
K5	Master kit w/steels MPCA	1	06-10	n/a	60211-11104
K6	Master kit w/o steels MPCA	1	06-10	n/a	60211-12104
K7	O/H gasket set w/seals-rings MPCA	1	06-10	FDB-2491	60203-13004
METAL CLAD SEALS					
G15	Seal, metal clad 44x68x8mm converter housing	1	06-10	91206-P0Z-005	50201A
G16	Seal, metal clad right axle	1	06-10	91206-PHR-003	60211-30300
G17	Seal, metal clad 35x56x8mm left axle	1	06-10	91205-PL3-A01	50211
NOTES					

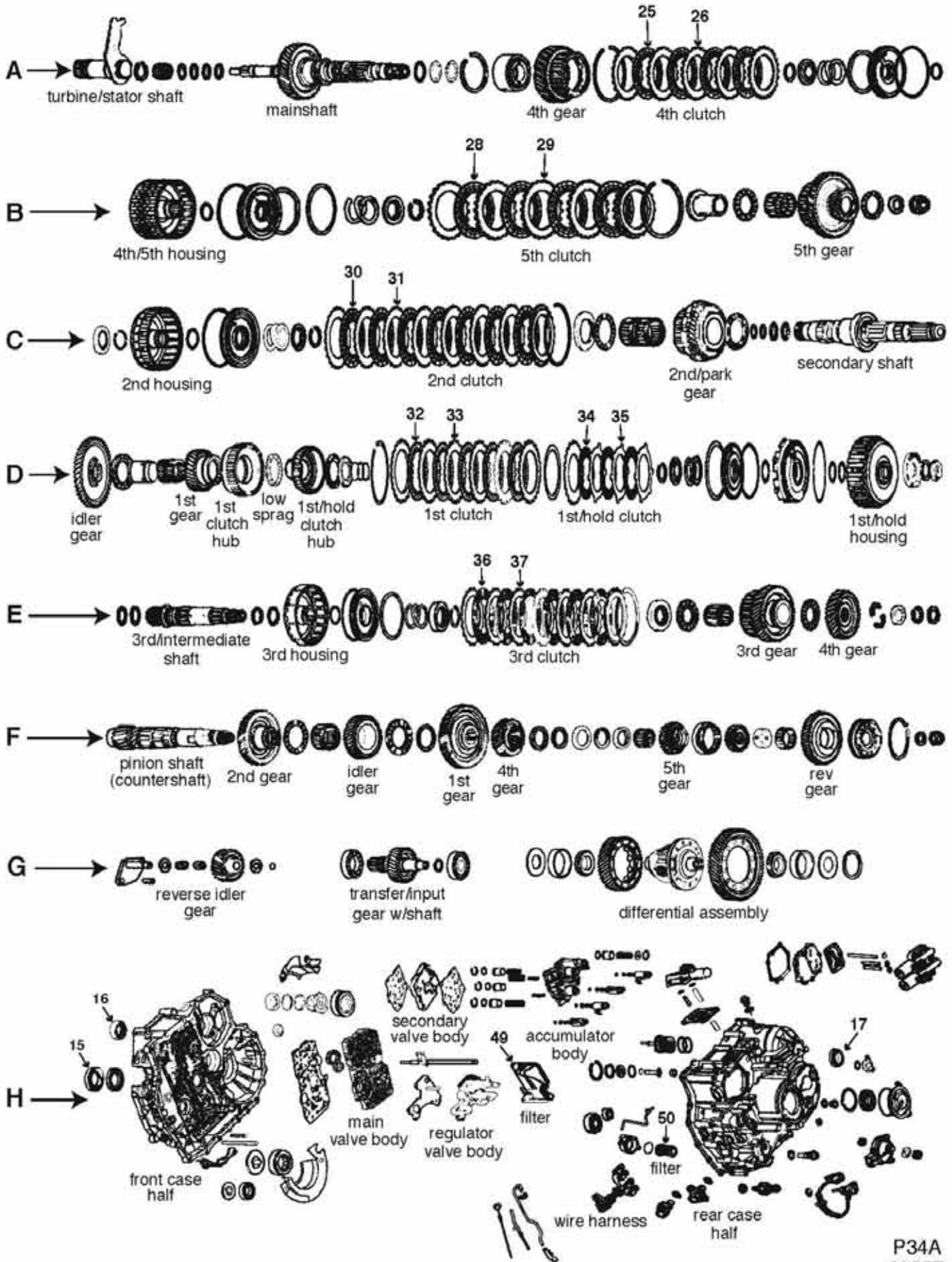

P34A
60257-

ILL	DESCRIPTION	QTY	YEAR	REFERENCE #	PART #
REBUILDER KITS					
K5	Master kit w/steels P34A	1	06-08	AE	60257-11104
K6	Master kit w/o steels P34A	1	06-08	AE	60257-12104
K7	O/H gasket set w/seals-rings P34A	1	06-08	FDB-2438	25166-13104
METAL CLAD SEALS					
H15	Seal, metal clad 46x70x8mm converter housing	1	06-08	91207-PR9-003	50201B
H16	Seal, metal clad 35x54x8mm right axle	1	06-08	91207-P7Z-003	50228
H17	Seal, metal clad 40x56x9mm left axle	1	06-08	91205-P0X-005	50210
FILTERS					
H50	Filter, cooler line (cartridge type) P34A	1	06-08	25450-P4V-013	50711
NOTES					

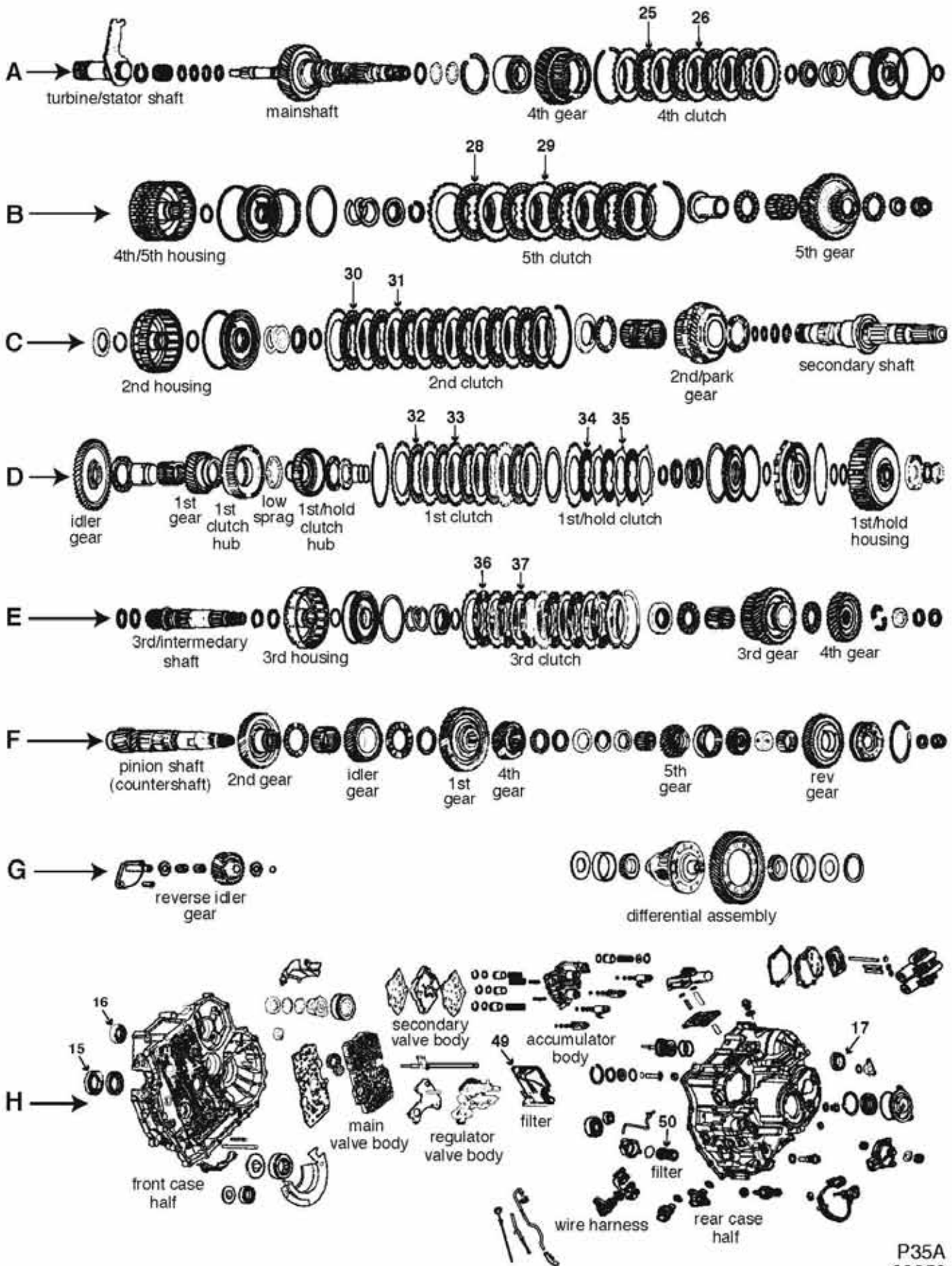

P35A
60258-

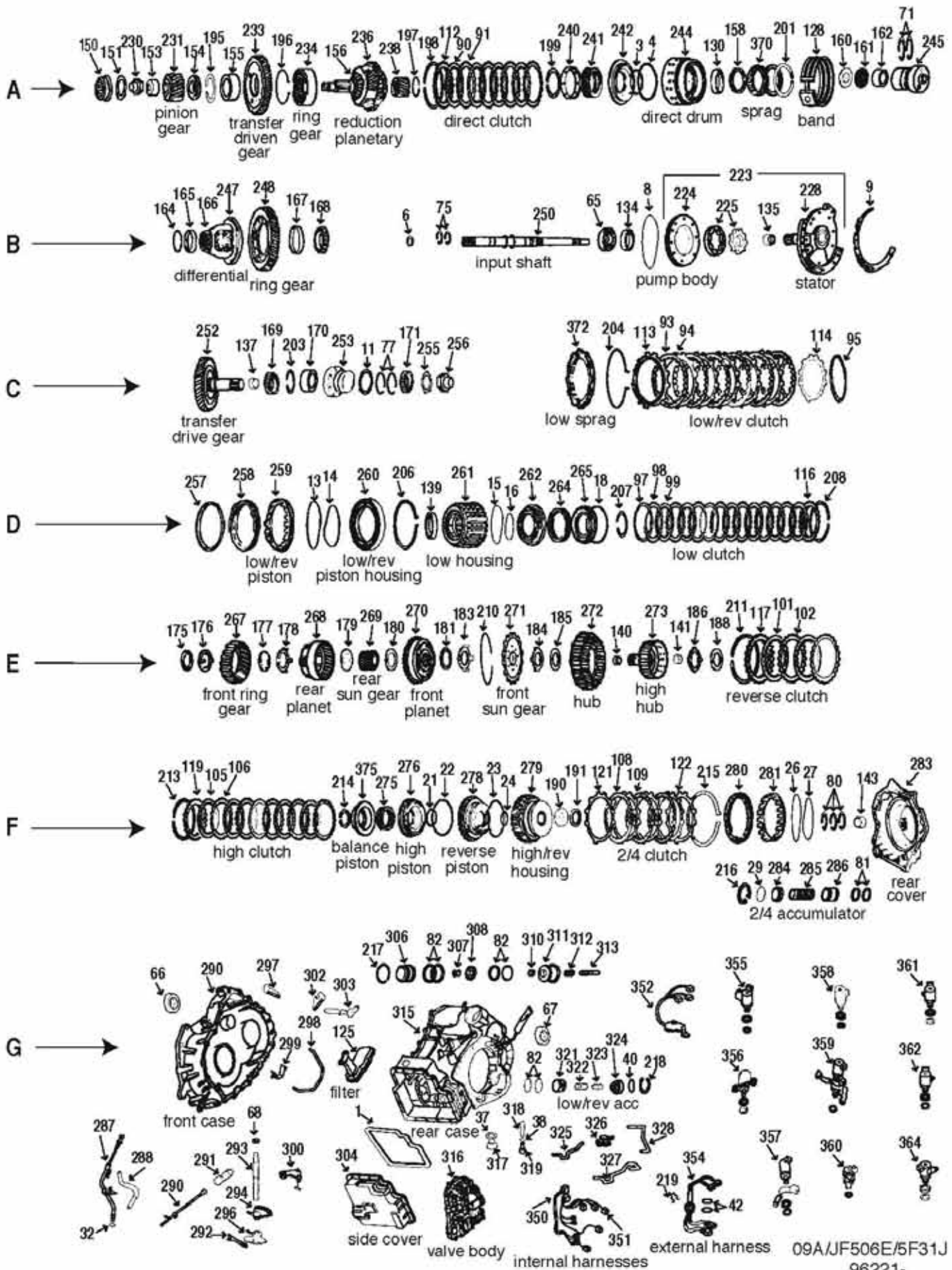

09A/JF506E/5F31J
96221-

ILL	DESCRIPTION	QTY	YEAR	REFERENCE #	PART #
TECHNICAL MANUALS					
K53	Tech manual JF506E dis/assembly	1	02-07	JF506ETM	010-465
K53	Update handbook parts	1	02-07	JF506EHB	010-466
REBUILDER KITS					
K5	Master kit w/steels w/piston	1	02-08	AE	96221-11004
K6	Master kit w/o steels w/piston	1	02-08	AE	96221-12004
K7	O/H gasket set w/seals-rings w/piston	1	02-08	FDB-2467	96221-13004
K15	Kit, valve body gasket	1	02-08	FDB-4761	75221-16004
VALVE BODY KITS					
K15	Kit, valve body repair	1	02-08	n/a	75221-17009
K15	Kit, valve body gasket	1	02-08	FDB-4761	75221-16004
GASKETS AND RUBBER COMPONENTS					
G1	Gasket, oil pan	1	02-10	n/a	75221-18104
G1	Gasket, oil pan	1	02-10	B11377	75221-19104
B6	O'ring	1	02-08	BV01-21-677	23721
B8	O'ring	1	02-08	BW01-21-032	23086
B9	Gasket, pump (metal coated)	1	02-08	FP01-19-221	75221-28004
G32	O'ring	1	02-08	99541-01201	1083
G42	O'ring	2	02-08	96041849	13045
n/i	Gasket, servo cover	1	02-08	31623-PW000	96221-29104
n/i	Washer	4	02-08	99562-1400	75221-28804
n/i	Ball, check .218" od (viton)	8	02-08	FDB-B30141	13923
n/i	Seal, valve body to case/accumulator cover	2	02-08	FP01-19-223	75221-23604
n/1	Seal, valve body to case/low reverse feed	2	02-08	FP01-19-778	75221-23704
n/i	Seal	1	02-08	FDB-B33228	96221-23604
METAL CLAD SEALS					
B65	Seal, metal clad	1	02-08	31375-PR000	81200
G66	Seal, metal clad	1	02-08	38342-PW000	96221-30204
G67	Seal, metal clad	1	02-08	38342-PW000	96221-30204
G68	Seal, metal clad	1	02-08	BV11-19-437	78210
SEALING RINGS					
K10	Kit, sealing ring	1	02-08	FDB-3478	75221-31504
A71	Sealing ring (plastic)	2	02-08	FP01-19-655	75221-33504
B75	Sealing ring (teflon)	3	02-08	FP01-19-256	75221-33704
C77	Sealing ring (plastic)	2	02-08	FP01-19257	75221-33804
F80	Sealing ring (teflon)	3	02-06	Fp01-19-212	75221-33904
F81	Sealing ring (teflon)	1	02-08	FP01-19-701	75221-34504
G82	Sealing ring (teflon)	4	02-08	FP01-19-701	75221-34504
CLUTCH PLATES					
A90	Friction .068" 4.026" od 26T	4	02-10	FP01-19-580	75221-35104
A91	Steel .079" 3.380" id 24T	4	02-10	FP01-19-499	75221-37504
A91	Steel .079" 3.380" 24T (wide teeth)	4	02-10	162701A-200	75221-37604
C93	Friction .071" 6.455" od 32T	7	02-10	FP01-19-590	90108
C94	Steel .055" 5.908" 10T	6	02-10	FP01-19-609	75221-37804
D98	Steel .055" 4.841" id 32T	7	02-10	FP01-19561	75221-38004
D99	Friction .068" 5.426" od 30T	7	02-10	FP01-19-5J0	75221-35404
E101	Friction .060" 6.141" od 32T	2	01-10	FP01-19-610	75221-36804
E102	Steel .078" 5.614" id 36T	2	02-10	FP01-19-571	75221-38204
F105	Friction .063" 4.415" od 24T	5	02-10	FP01-19-620	90102A
F106	Steel .095" 3.596" id 18T	4	02-10	FP01-19-6E1	75221-38404
F106	Steel .063" 3.596" id 18T	1	02-10	FP01-19-6E2	75221-38504
F108	Friction .063" 7.534" od 32T	6	02-10	FP01-19-3V0	75221-37004
F109	Steel .118" 6.663" id 7T	2	02-10	FP01-19-3N4	75221-38804
E117	Pressure plate .157" 5.615" id 36T	1	02-08	AE	75221-41803

09A•JF506E•5F31J

09A•JF506E•5F31J

ILL	DESCRIPTION	QTY	YEAR	REFERENCE #	PART #
PRESSURE PLATES					
A112	Pressure plate .163" 3.385" id 24T direct clutch	1	02-08	AE	96221-41103
E113	Pressure plate .148" 5.615" id 10T low/reverse clutch (stepped)	1	02-08	AE	96221-41403
C114	Pressure plate (apply) .100" 5.910" id 10T low/reverse clutch	1	02-08	AE	96221-41603
D116	Pressure plate .170" 4.845" id 32T low clutch	1	02-08	AE	96221-41803
E117	Pressure plate .141" 5.615" id 36T reverse clutch	sel	02-08	AE	75221-41603
E117	Pressure plate .150" 5.615" id 36T reverse clutch	sel	02-08	AE	75221-41703
E117	Pressure plate .165" 5.615" id 36T reverse clutch	sel	02-10	AE	75221-41903
F119	Pressure plate .205" 3.610" id 18T high clutch	1	02-08	AE	75221-42503
F121	Pressure plate .163" 6.625" id 7T 2/4 clutch (apply)	1	02-08	AE	75221-43003
F122	Pressure plate (apply) .140" 6.625" id 7T 2/4 clutch	1	02-08	AE	96221-43203
FILTERS					
K9	Kit, filter Audi/Volkswagen (09A0 (neoprene/cork)	1	02-07	AE	96221-43604
K9	Kit, filter Audo/Volkswagen (09A)(Duraprene®)	1	02-07	AE	96221-44104
G125	Filter Audi/Volkswagen (09A)	1	02-07	09A-325-429	96221-45104
BANDS					
A128	Band (split type) JF560E/RE5F01A (reduction brake)	1	02-08	31630-PW002	75221-47504
BUSHINGS					
K13	Kit, bushing JF506E/JA5A-EL/5F31	1	02-08	AE	75221-50004
B134	Bushing pump body	1	02-08	AE	91005
A130	Bushing direct clutch housing	1	02-08	n/a	75221-50804
B135	Bushing stator support (front)	1	02-08	n/a	75221-51004
C137	Bushing drive gear (rear)	1	02-08	n/a	75221-51304
D139	Bushing low clutch housing	1	02-08	n/a	75221-51504
E140	Bushing reverse clutch hub (front)	1	02-08	n/a	75221-51804
E141	Bushing reverse clutch hub (rear)	1	02-08	n/a	75221-51804
F143	Bushing end cover	1	02-08	n/a	75221-52104
WASHERS/BEARINGS/RACES/SHIMS					
C173	Washer, lock nut to inner bearing	1	02-08	n/a	75221-58503
K14	Kit, thrust washer 09A/JF506E	1	02-08	AE	96221-54504
K12	Kit, thrust bearing 09A/JF506E	1	02-08	AE	96221-55104
A150	Bearing, caged 2.755" od reduction planetary to case	1	02-08	n/a	75221-56104
A151	Bearing, thrust pinion gear to caged bearing	1	02-08	n/a	96221-56204
A153	Race, inner pinion gear	1	02-08	n/a	75221-56304
A155	Bearing, double cone w/wide cone driven gear (ill# A154/A155)	1	02-08	n/a	75221-56404
E158	Bearing, thrust direct housing to support	1	02-08	n/a	75221-56604
A160	Bearing, thrust direct housing to support	1	02-08	n/a	75221-56804
A161	Bearing, thrust reduction sun gear to support	1	02-10	n/a	96221-56904
A162	Bearing, caged direct housing to support	1	02-08	n/a	75221-57204
B164	Shim, 7.735" id differential bearing	1	02-08	n/a	96221-57304
B168	Bearing, cup/cone differential to housing	1	02-10	n/a	96221-57504
C170	Bearing, double cup/cone drive gear to support (ill# 169/170/171)	1	02-08	n/a	75221-58004
E175	Bearing, thrust support to rear planetary	1	02-08	n/a	75221-58604
E176	Bearing, thrust support to rear planetary	1	02-08	n/a	75221-58704
E177	Bearing, thrust rear ring gear to rear planetary	1	02-08	n/a	75221-58804
E178	Race, thrust bearing rear ring gear to planetary	1	02-08	n/a	75221-58904
E179	Bearing, thrust rear planetary to sun gear	1	02-08	n/a	75221-59004
E180	Bearing, thrust sun gear to front planetary	1	02-08	n/a	75221-59104
E181	Bearing, thrust front planetary to sun gear	1	02-08	n/a	75221-59204
E183	Race, thrust bearing front planetary to sun gear	1	02-08	n/a	75221-59304
E184	Race, thrust bearing high clutch hub to sun gear	1	02-08	n/a	75221-59404
E185	Bearing, thrust high clutch hub to sun gear	1	02-08	n/a	75221-58804
E186	Race, thrust bearing high clutch hub to reverse housing	1	02-08	n/a	75221-59604
E188	Bearing, thrust high clutch hub to reverse housing	1	02-08	n/a	75221-59704

ILL	DESCRIPTION	QTY	YEAR	REFERENCE #	PART #
WASHERS/BEARINGS/RACES/SHIMS (CONTINUED)					
F190	Bearing, thrust reverse housing to end housing	1	02-08	n/a	75221-60104
F191	Shim .982" id reverse housing to end housing	sel	02-08	n/a	75221-60204
SNAP RINGS					
A195	Snap ring .063" 3.068" od bearing to driven gear	1	02-08	AE	75221-62103
A196	Snap ring .068" 5.465" od ring gear to reduction planetary	1	02-08	AE	75221-62203
A197	Snap ring .078" 1.912" od direct clutch drum seat	1	02-08	AE	75221-62303
A198	Snap ring .080" 4.312" od direct clutch pressure plate	1	02-08	AE	75221-62403
A199	Snap ring .041" 2.308" od direct clutch retainer	1	02-08	AE	75221-62503
A201	Snap ring .039" 3.412" od sprag in direct drum	1	02-08	AE	75221-62603
C203	Snap ring .064" 2.478" od bearing in support	1	02-08	AE	75221-62703
C203	Snap ring .034" 2.362" od bearing in support	1	02-08	AE	96221-62803
C204	Snap ring .049" 6.975" od low sprag to case (w/external tabs)	1	02-08	AE	75221-63003
D206	Snap ring .088" low/reverse housing in case	1	02-08	AE	96221-63503
D207	Snap ring .054" 3.356" od low clutch retainer	1	02-08	AE	75221-63703
D208	Snap ring .063" 5.694" od low clutch pressure plate	1	02-08	AE	75221-63903
E210	Snap ring .063" 5.299" od sun gear in low housing	1	02-08	AE	75221-64303
E211	Snap ring .079" 6.502" od reverse clutch pressure plate	1	02-08	AE	75221-64603
F213	Snap ring .079" 4.766" od high clutch pressure plate	1	02-08	AE	75221-64903
F214	Snap ring high clutch retainer	1	02-08	AE	75221-65203
F215	Snap ring .080" 8.125" od 2-4 retainer	1	02-08	AE	75221-65503
G216	Snap ring 2-4 accumulator cover	1	02-08	AE	75221-65703
G218	Snap ring low/reverse accumulator cover	1	02-08	AE	75221-65903
PUMP PARTS AND PUMPS					
B223	Pump assembly 09A/JF506E	1	02-08	AE	75221-67003
B224	Body, pump w/gears 09A/JF506E	1	02-08	AE	75221-67503
B225	Gears, pump (inner/outer) 09A/JF506E	1	02-08	AE	75221-68104
B228	Stator, pump 09A/JF506E	1	02-08	AE	75221-68503
HARD PARTS					
A230	Nut reduction planetary	1	02-08	AE	75221-72303
A231	Gear, pinion 1.540" no groove 20T 09A/JF506E	1	02-08	AR	96221-72403
A233	Gear, driven transfer 1 groove 67T 09A/JF506E	1	02-08	AE	96221-72803
A234	Gear, ring no slots 5.435" od 85T 09A/JF506E	1	02-08	AE	75221-73003
A234	Planetary, reduction w/shaft 1groove uses 31T sun gear	1	02-08	AE	96221-73403
A238	Gear, sun 1 groove 31T 09A/JF506E	1	02-08	AE	96221-73803
A240	Retainer, w/o spring direct clutch	1	02-08	AE	75221-74003
A241	Spring, accordion direct clutch	1	02-08	AE	75221-74103
A242	Piston .270" 3.980" od direct clutch	1	02-10	AE	96221-74203
A244	Drum, direct 31 splines .425" from piston edge to top of drum	1	02-08	AE	96221-74403
A245	Support, direct drum 2.875" oh 09A/JF506E	1	02-08	AE	75221-74703
B247	Differential w/spider gears w/2 large holes 30 axle splines	1	02-08	AE	96221-75003
B247	Gear, ring 1.245" no groove 69T 12 bolt (no id grooves top side)	1	02-08	AE	96221-75303
B250	Shaft, input 20 splines 12.500" length 2-sealing rings grooves	1	02-08	AE	71221-75303
C252	Gear, drive transfer .985" id 5.920" od 52T (2-ring input shaft)	1	02-08	AE	96221-75803
C253	Support, drive transfer gear no notches inside (2 snap ring grooves)	1	02-08	AE	96221-76003
C256	Nut transfer drive gear	1	02-08	AE	75221-76203
D257	Retainer, 7.312" od low/reverse clutch	1	02-08	AE	75221-76503
D258	Spring, accordion low/reverse clutch return	1	02-08	AE	75221-76603
D259	Piston .780" oh (aluminum) low/reverse clutch	1	02-08	AE	96221-76703
D260	Housing .805" oh low/reverse clutch	1	00-08	AE	96221-76803
D261	Housing, low clutch 09A/JF506E	1	02-08	AE	75221-77003
D262	Piston 1.260" oh (aluminum) 09A/JF506E	1	02-08	AE	75221-77203
D264	Spring, accordion low clutch return	1	02-08	AE	75221-77403
D265	Retainer, alum .300" oh 12 id notches low clutch spring	1	02-08	AE	75221-77503

09A•JF506E•5F31J

09A•JF506E•5F31J

ILL	DESCRIPTION	QTY	YEAR	REFERENCE #	PART #	
HARD PARTS (CONTINUED)						
E267	Gear, front ring 75T	09A/JF506E	1	02-08	AE	75221-77803
E268	Planetary, rear 5 pinion gears	output	1	02-08	AE	75221-78003
E269	Gear, rear sun .910" 20 splines 42T	09A/JF506E	1	02-08	AE	75221-78203
E270	Planetary, front 4 pinion gears	forward	1	02-08	AE	75221-78503
E271	Gear, front sun 32 outer lugs 34T	09A/JF506E	1	02-08	AE	75221-78803
E272	Hub, 32T	reverse/2nd clutch	1	02-08	AE	75221-79003
E273	Hub, 2.815" oh 24T	09A/JF506E high clutch	1	02-08	AE	75221-79203
F275	Spring, accordion 1.075" oh 2.875" od	high clutch return	1	02-08	AE	75221-79403
F276	Piston .890" 4.405" od (aluminum)	high clutch	1	02-08	AE	75221-79503
F278	Piston 2.115" oh (aluminum)	reverse clutch	1	02-08	FP-03-19-480	75221-79704
E278	Piston 2.115" oh (aluminum)	reverse clutch	1	02-08	AE	75221-79703
F279	Housing, 2.875" oh 36T (stamp steel)	high/reverse clutch & 2/4 clutch hub	1	02-08	AE	75221-80103
F280	Retainer, w/springs	2/4 clutch return	1	02-08	AE	75221-80303
F281	Piston 1.545" oh 7.500" od 20 lugs	2/4 clutch	1	02-08	AE	75221-80403
F283	Housing, end	rear cover	1	02-08	AE	96221-80503
G290	Case, front half (square starter hole)	21 case bolts external cooler on top	1	02-08	#JP JC7 091	96221-81103
G304	Pan, side cover	filler tube hole .750" od vent hole .250" od	1	02-06	AE	96221-82203
G315	Case, rear half (main) 3 bolts holds servo	21 case bolts w/o case vent	1	02-08	AE	96221-82803
G316	VB w/solenoids w/2 flush alum end caps	w/2 tubes/steel solenoid brackets	1	02-08	AE	96221-83003
ELECTRICAL COMPONENTS						
n/i	Kit, solenoid (9 solenoids)	09A/JF506E	1	02-08	D183420A	96221-85004
G350	Harness, wiring internal 20 wire	w/2 ten/1 eight prong square connector	1	02-08	n/a	96221-90404
G351	Harness, wiring internal w/ground wire	10 prong w/9 one blade connector	1	02-08	n/a	96221-90504
G352	Switch, MLPS (neutral start)	09A/JF506E	1	02-08	n/a	96221-90704
G354	Harness, wiring external 5.500" length	20 wire w/2 eight prong square connector	1	02-08	n/a	96221-90904
G355	Soleniod	lock-up/TCC (N91)	1	02-06	31941-PR010	96221-87104
G356	Soleniod	pressure control (N93)	1	02-07	FP01-21-1DY	75221-87504
G357	Soleniod	low clutch timing (N90)	1	02-06	31941-PR007	96221-89004
G358	Soleniod	2/4 brake duty (N283)	1	02-08	D183450A	96221-87704
G359	Soleniod	2/4 brake timing (N282)	1	02-06	31941-PR008	96221-89304
G360	Soleniod	reduction timing (N281)	1	02-07	31941-PR014	96221-89504
G361	Soleniod	shift B (N89)	1	02-07	D183422A	75221-88304
G362	Soleniod	shift C (N92)	1	02-06	31941-PR005	96221-88904
G364	Soleniod	shift A (N88)	1	02-06	31941-PR006	96221-88604
SPRAGS						
A370	Sprag, reduction .632" (28 elements)	09A/JF506E	1	02-08	n/a	75221-94004
A370	Sprag, reduction .632" (28 elements)	09A/JF506E	1	02-08	AE	75221-94003
C372	Sprag, low .515" (18 roller)	09A/JF506E	1	02-08	n/a	75221-94504
C372	Sprag, low .515" (18 roller)	09A/JF506E	1	02-08	AE	75221-94503
BONDED PISTONS						
F375	Piston, balance bonded rubber	JF506E (high clutch)	1	02-06	B81899	75221-97104
NOTES						

sonnax®



...keeps the comebacks away.

The valve body is the brains of a transmission.

That transmission isn't fixed until the valve body is right. And that means getting to the root cause of the problem, not just treating the symptoms.

Nobody knows valve bodies like Sonnax.™

sonnax®
TIME TESTED • INDUSTRY TRUSTED®



1 Automatic Drive • P.O. Box 440 • Bellows Falls, VT 05101-0440 USA
800-843-2600 • 802-463-9722 • F: 802-463-4059 • www.sonnax.com

©2010 Sonnax Enterprises, Inc.

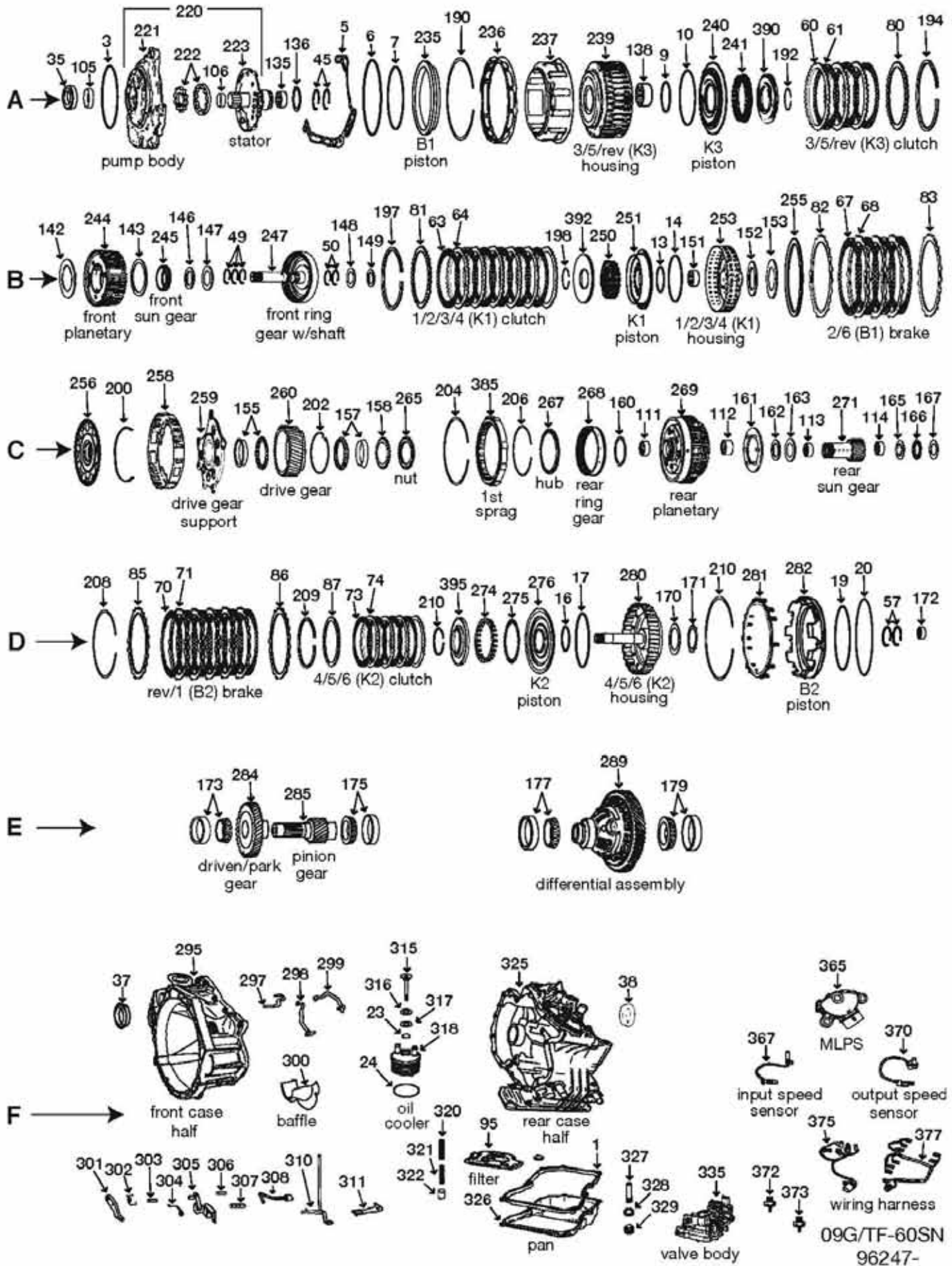

ILL	DESCRIPTION		QTY	YEAR	REFERENCE #	PART #
TECHNICAL MANUALS						
K53	Tech manual TS60SN/09G dis/assembly	diagnosis/troubleshooting	1	03-10	TS60SN/09G	010-482
REBUILDER KITS						
K5	Master kit w/steels	TF-60SN/09G w/bonded pistons	1	03-10	AE	96247-11004
K5	Master kit w/steels	TF-60SN/09G w/o bonded pistons	1	03-10	AE	96247-11104
K5	Master kit w/steels	TF-62SN/09K w/bonded pistons	1	03-10	AE	96247-11504
K5	Master kit w/steels	TF-62SN/09K w/o bonded pistons	1	03-10	AE	96247-11604
K6	Master kit w/o steels	TF-60SN/09G w/bonded pistons	1	03-10	AE	96247-12004
K6	Master kit w/o steels	TF-60SN/09G w/o bonded pistons	1	03-10	AE	96247-12104
K6	Master kit w/o steels	TF-62SN/09K w/bonded pistons	1	03-10	AE	96247-12504
K6	Master kit w/o steels	TF-62SN/09K w/o bonded pistons	1	03-10	AE	96247-12604
K7	O/H gasket set w/seals-rings	TF-60SN/09G w/bonded pistons	1	03-10	AE	96247-13004
K7	O/H gasket set w/seals-rings	TF-60SN/09G w/o bonded pistons	1	03-10	FDB-2526	96247-13104
K7	O/H gasket set w/seals-rings	TF-62SN/09K w/bonded pistons	1	03-10	AE	96247-13504
K7	O/H gasket set w/seals-rings	TF-62SN/09K w/o bonded pistons	1	03-10	FDB-2553	96247-13604
n/i	Kit, bonded piston (4 pistons)	TF-60SN/09G	1	03-10	n/a	96247-99504
VALVE BODY KITS						
K15	Shift Kit® corrects rough downshifts	poor shifts/TCC shudder/slow response	1	03-10	SK® 09G	96247-17009
GASKETS AND RUBBER COMPONENTS						
F1	Gasket, oil pan (molded rubber)	TF-60SN/02E/09G	1	03-10	FDB-B33390	96247-20104
F1	Gasket, oil pan (molded rubber)	TF-62SN/09K	1	03-10	FDB-B33421	96247-20204
METAL CLAD SEALS						
A35	Metal clad seal	front (TF-60SN/09G/TF-62SN/09K)	1	03-10	FDB-B37115	96247-30004
F37	Metal clad seal	right axle (TF-60SN/09G)	2	03-10	FDB-B37056	96247-30104
F37	Metal clad seal	right axle (TF-62SN/09K)	2	03-10	FDB-B37167	96247-30404
F38	Metal clad seal	left axle (TF-60SN/09G)	1	04-10	FDB-B37056	96247-30104
F38	Metal clad seal	left axle (TF-62SN/09K)	1	03-10	FDB-B37167	96247-30404
SEALING RINGS						
K10	Kit, sealing ring	TF-60SN/09G/TF-62SN/09K	1	03-10	FDB-B3524	96247-31504
A45	Sealing ring	pump support	1	03-10	n/a	96247-33104
B49	Sealing ring	turbine shaft (front)	3	03-10	n/a	96247-33404
B50	Sealing ring	turbine shaft (rear)	2	03-10	n/a	96247-33604
D57	Sealing ring	K2 clutch	1	03-10	n/a	96247-33804
CLUTCH PLATES						
A60	Steel .071" 5.149" id 40T	3rd/5th/reverse clutch (K-3)	3	03-10	129709-180	96247-37504
A61	Friction .066" 6.180" od 56T	3rd/5th/reverse clutch (K-3)	3	03-10	129708-173	96247-35104
B63	Friction .066" 5.790" od 56T	1st/2nd/3rd/4th clutch (K-1)	5	03-10	129704-168	96247-35204
B64	Steel .070" 5.148" id 40T	1st/2nd/3rd/4th clutch (K-1)	5	03-10	129705-180	96247-37604
B67	Friction .066" 7.245" od 40T	2nd/6th clutch (B-1)	4	03-10	129700-170	96247-35304
B68	Steel .072" 6.611" id 12T	2nd/6th clutch (B-1)	3	03-10	129701-180	96247-37704
D70	Friction .067" 6.716" od 56T	reverse/1st brake clutch (B-2)	6	03-10	129702-173	96247-35404
D71	Steel .072" 6.220" id 14T	reverse/1st brake clutch (B-2)	5	03-10	129703-183	96247-37804
D73	Friction .067" 5.725" od 55T	4th/5th/6th clutch (09G) (K-2)	3	03-10	129706-170	96247-35504
D73	Friction .060" 5.725" od 60T	4th/5th/6th clutch (09K/09M) (K-2)	6	03-10	129706A-152	96247-35604
D74	Steel .071" 5.000" id 24T	4th/5th/6th clutch (K-2)	3/6	03-10	129707-180	96247-37904
PRESSURE PLATES						
A80	Pressure plate	3/5/reverse clutch (K-3)	1	03-10	AE	96247-41103
B81	Pressure plate	1/2/3/4 clutch	1	03-10	AE	96247-41303
B82	Pressure plate (apply)	2nd/6th clutch (B-1)	1	03-10	AE	96247-41403
B83	Pressure plate	2/6 clutch	1	03-10	AE	96247-41603
D85	Pressure plate	reverse/1st brake clutch	1	03-10	AE	96247-42203
D86	Pressure plate (apply)	reverse/1st brake clutch	1	03-10	AE	96247-42503
D87	Pressure plate	4/5/6 clutch	1	03-10	AE	96247-42703

TF-60SN•09G•09K•09M•TF-62SN•6F21A

TF-60SN•09G•09K•09M•TF-62SN•6F21A

ILL	DESCRIPTION	QTY	YEAR	REFERENCE #	PART #
FILTERS					
K9	Kit, filter neoprene/cork	1	03-10	AE	96247-43504
F95	Filter, main suction	1	03-10	133710-AFT	96247-45004
BUSHINGS					
K12	Kit, bushing	1	03-10	AE	96247-50104
A105	Bushing (dimpled)	1	03-10	n/a	96247-50604
A106	Bushing (dimpled)	1	03-10	n/a	96247-50704
C111	Bushing (dimpled)	1	03-10	n/a	96247-51004
C112	Bushing (dimpled)	1	03-10	n/a	96247-51104
C113	Bushing (dimpled)	1	03-10	n/a	96247-51204
C114	Bushing (dimpled)	1	03-10	n/a	96247-51204
WASHERS/BEARINGS/RACES/SHIMS					
A135	Bearing, caged	1	03-11	n/a	96247-56204
A140	Washer, thrust	1	03-10	n/a	96247-56304
A138	Bearing, caged	1	03-10	n/a	96247-56504
B142	Washer, thrust	1	03-10	n/a	96247-56704
B143	Washer, thrust	1	03-10	n/a	96247-56804
B146	Race, thrust	1	03-10	n/a	96247-57004
B147	Bearing, thrust	1	03-10	n/a	96247-57104
B148	Race, thrust	1	03-10	n/a	96247-57304
B149	Bearing, thrust	1	03-10	n/a	96247-57404
B151	Bearing, caged	1	03-10	n/a	96247-57604
B152	Bearing, caged	1	03-10	n/a	96247-57804
B153	Race, thrust	1	03-10	n/a	96247-57904
C155	Bearing, cup/cone	1	03-10	n/a	96247-58104
C157	Bearing, cup/cone	1	03-10	n/a	96247-58104
C158	Washer, retainer lock	1	03-10	n/a	96247-58304
C160	Washer, thrust	1	03-10	n/a	96247-58504
C161	Washer, thrust (lube)	1	03-10	n/a	96247-58604
C162	Bearing, thrust	1	03-10	n/a	96247-58804
C163	Race, thrust	1	03-10	n/a	96247-58904
C165	Race, thrust	1	03-10	n/a	96247-59004
C166	Bearing, thrust	1	03-10	n/a	96247-59104
C167	Race, thrust	1	03-10	n/a	96247-59204
D170	Bearing, thrust	1	03-10	n/a	96247-59504
D171	Race, thrust	1	03-10	n/a	96247-59604
D172	Bearing, caged	1	03-10	n/a	96247-59704
E173	Bearing, cup/cone	1	03-10	n/a	96247-59804
E175	Bearing, cup/cone	1	03-10	n/a	96247-59904
E177	Bearing, cup/cone	1	03-10	n/a	96247-60104
E179	Bearing, cup/cone	1	03-10	n/a	96247-60204
SNAP RINGS					
A190	Snap ring	1	03-10	AE	96247-62303
A192	Snap ring	1	03-10	AE	96247-62503
A194	Snap ring	1	03-10	AE	96247-62803
B197	Snap ring	1	03-10	AE	96247-63103
B198	Snap ring	1	03-10	AE	96247-63203
C200	Snap ring	1	03-10	AE	96247-63303
C202	Snap ring	1	03-10	AE	96247-63503
C204	Snap ring	1	03-10	AE	96247-63803
C206	Snap ring	1	03-10	AE	96247-64103
D208	Snap ring	1	03-10	AE	96247-64303
D209	Snap ring	1	03-10	AE	96247-64503
D210	Snap ring	1	03-10	AE	96247-64603

ILL	DESCRIPTION	QTY	YEAR	REFERENCE #	PART #
SNAP RINGS (CONTINUED)					
D211	Snap ring B2 clutch retainer	1	03-10	AE	96247-64803
PUMP PARTS AND PUMPS					
A220	Pump assembly TF-60SN/09G	1	03-10	AE	96247-67003
HARD PARTS					
A235	Piston, B1 clutch TF-60SN/09G	1	03-10	AE	96247-72303
A236	Retainer, w/springs B1 clutch	1	03-10	AE	96247-72503
A237	Retainer, spacer B1 clutch	1	03-10	AE	96247-72603
A239	Housing, K3 clutch TF-60SN/09G	1	03-10	AE	96247-72703
A240	Piston, K3 clutch TF-60SN/09G	1	03-10	AE	96247-73003
A241	Retainer, w/springs K3 clutch	1	03-10	AE	96247-73103
B244	Planetary, front TF-60SN/09G	1	03-10	AE	96247-73303
B245	Gear, front sun TF-60SN/09G	1	03-10	AE	96247-73603
B247	Gear, front ring w/shaft TF-60SN/09G	1	03-10	AE	96247-74003
B250	Retainer, w/springs K1 clutch	1	03-10	AE	96247-74203
B251	Piston, K1 clutch TF-60SN/09G	1	03-10	AE	96247-74303
B253	Housing, K1 clutch TF-60SN/09G	1	03-10	AE	96247-74503
B255	Plate, cushion B1 brake clutch	1	03-10	AE	96247-74803
C256	Shell, drive TF-60SN/09G	1	03-10	AE	96247-75003
C258	Hub, retainer TF-60SN/09G	1	03-10	AE	96247-75203
C259	Support, drive gear TF-60SN/09G	1	03-10	AE	96247-75403
C260	Gear, drive TF-60SN/09G	1	03-10	AE	96247-75703
C265	Nut, drive gear TF-60SN/09G	1	03-10	AE	96247-75903
C267	Hub, ring gear drive TF-60SN/09G	1	03-10	AE	96247-76103
C268	Gear, rear ring TF-60SN/09G	1	03-10	AE	96247-76203
C269	Planetary, rear w/inner sprag race	1	03-10	AE	96247-77003
C271	Gear, rear sun TF-60SN/09G	1	03-10	AE	96247-77303
D274	Retainer, w/springs K2 clutch	1	03-10	AE	96247-77603
D275	Guide, K2 clutch retainer TF-60SN/09G	1	03-10	AE	96247-77803
D276	Piston , K2 clutch TF-60SN/09G	1	03-10	AE	96247-78003
D280	Housing, K2 clutch TF-60SN/09G	1	03-10	AE	96247-78303
D281	Retainer, w/springs B2 clutch	1	03-10	AE	96247-78603
D282	Piston, B2 clutch TF-60SN/09G	1	03-10	AE	96247-78803
E284	Gear, driven w/park gear TF-60SN/09G	1	03-10	AE	96247-79003
E285	Gear, pinion/differential w/ring gear/spider gears	1	03-10	AE	96247-79303
E289	Gear, pinion/differential w/ring gear/spider gears	1	03-10	AE	96247-79303
F295	Housing, front case TF-60SN/09G	1	03-10	AE	96247-80103
F301	Pawl, park TF-60SN/09G	1	03-10	AE	96247-80703
F302	Spring, park pawl TF-60SN/09G	1	03-10	AE	96247-80803
F309	Pin, park pawl TF-60SN/09G	1	03-10	AE	96247-80903
F311	Spring, roller detent TF-60SN/09G	1	03-10	AE	96247-81503
F318	Cooler, oil TF-60SN/09G	1	03-10	AE	96247-81903
F325	Housing, rear case TF-60SN/09G	1	03-10	AE	96247-82003
F326	Pan, bottom TF-60SN/09G	1	03-10	AE	96247-82503
F335	Valve body w/solenoids TF-60SN/09G	1	03-10	AE	96247-84003

MULTI-CLUTCH BILLET CONVERTERS

DACCO



Heavy duty applications available for GM, Dodge, and Ford Trucks.

CUSTOMER DRIVEN
QUALITY FOCUSED
EMPLOYEE POWERED

DACCO
TRANSMISSION PARTS

Check out our website at:
www.daccoinc.com

 facebook.com/DACCOTrans

02E•DSG•DQ25 (Dual Clutch)

02E•DSG•DQ25

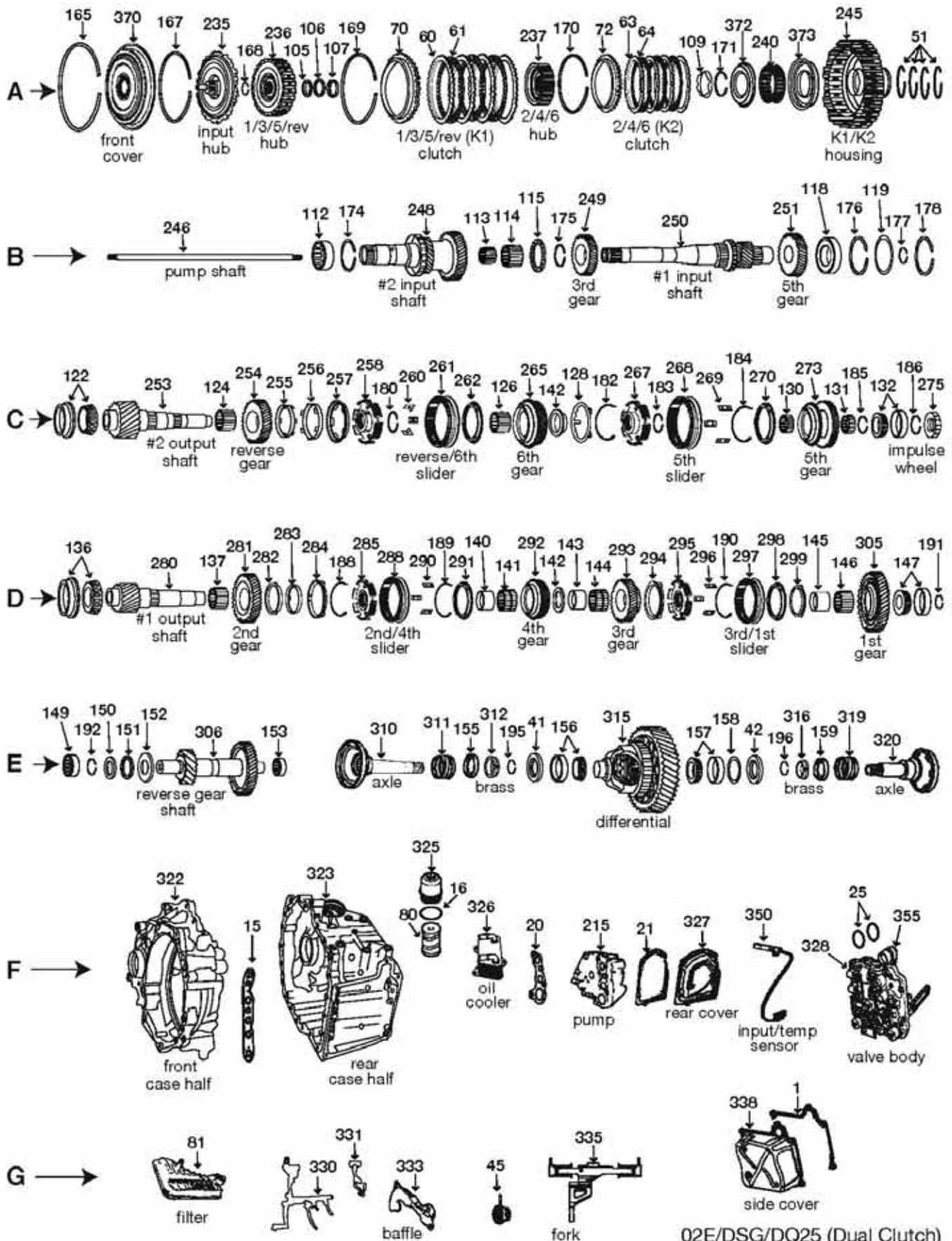

02E/DSG/DQ25 (Dual Clutch)
96252-

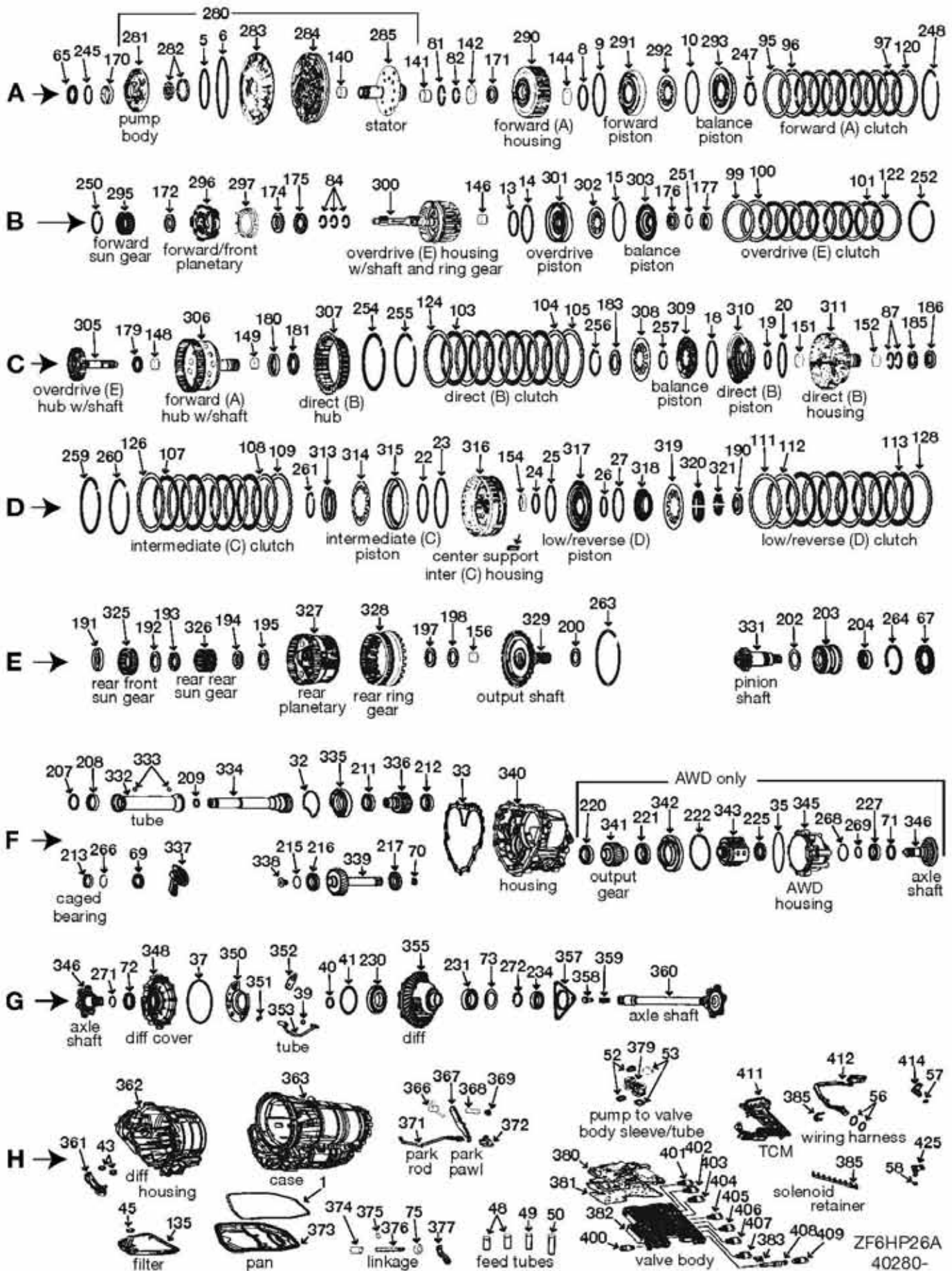

ILL	DESCRIPTION		QTY	YEAR	REFERENCE #	PART #
TECHNICAL MANUALS						
K53	Tech manual 6R60/ZF6HP26 dis/assembly	diagnosis & troubleshooting	1	02-11	ZF6HP26TM	010-232
REBUILDER KITS						
K5	Master kit w/steels	w/o bonded separator plate	1	02-11	AE	45158-11104
K6	Master kit w/o steels	w/o bonded separator plate	1	02-11	AE	45158-12104
K7	O/H gasket set w/seals-rings	w/o bonded separator plate	1	02-11	AE	45158-13104
GASKETS AND RUBBER COMPONENTS						
H1	Gasket, oil pan (w/molded rubber edge)	ZF6HP26A	1	02-11	FDB-B33324	15158-20104
A5	O'ring	pump body	1	02-11	MGW-86154	15158-21004
A6	O'ring	pump plate	1	02-11	6L2Z-7A248-CA	15158-21204
METAL CLAD SEALS						
A65	Seal, metal clad	front	1	02-11	6L2Z-7A248-AA	15158-30004
E67	Seal, metal clad	pinion shaft	1	02-11	n/a	40280-30304
F69	Seal, metal clad	retainer	1	02-11	n/a	40280-30404
F70	Seal, metal clad	transfer shaft	1	02-11	n/a	40280-30504
F71	Seal, metal clad	AWD housing	1	02-11	n/a	40280-30604
G72	Seal, metal clad	differential cover	1	02-11	n/a	40280-30704
G73	Seal, metal clad	axle shaft	1	02-11	n/a	40280-30804
SEALING RINGS						
K10	Kit, sealing ring	ZF6HP26A	1	02-11	n/a	15158-31504
A81	Ring, sealing (metal)	pump stator	1	02-11	n/a	15158-32004
A82	Ring, sealing (metal)	pump stator	1	02-11	n/a	15158-32304
B84	Ring, sealing (plastic)	turbine shaft (overdrive housing)	3	02-11	n/a	15158-33204
C87	Ring, sealing (teflon)	direct clutch housing	1	02-11	n/a	15158-33504
CLUTCH PLATES						
A95	Steel .035" 6.450" id 30T (waved plate)	forward clutch (A)	1	02-11	n/a	15158-37704
A96	Steel .118" 6.450" id 30T	forward clutch (A)	4/5	02-11	1068-377-020	15158-37504
A96	Steel .105" 6.450" id 30T	forward clutch (A)	sel	02-11	1068-377-023	15158-38304
A96	Steel .130" 6.450" id 30T	forward clutch (A)	sel	02-11	1068-377-024	15158-38404
A96	Steel .142" 6.450" id 30T	forward clutch (A)	sel	02-11	1068-377-025	15158-38504
A97	Friction .063" 7.370" od 30T	forward clutch (A)	4/5	02-11	1068-277-004	15158-35204
B99	Steel .030" 4.200" id 24T (waved plate)	overdrive clutch (E)	1	02-11	n/a	15158-37804
B100	Steel .118" 4.200" id 24T	overdrive clutch (E)	6/7	02-11	1068-371-030	15158-38004
B100	Steel .095" 4.200" id 24T	overdrive clutch (E) (some models)	6/7	02-11	APC-183703-240	15158-38104
B101	Friction .063" 5.150" od 30T	overdrive clutch (E)	6	02-11	n/a	15158-35604
B101	Friction .079" 5.150" od 30T	overdrive clutch (E)	sel	02-11	APC-183702-200	15158-35704
C103	Friction .087" 7.370" od 30T	direct clutch (B)	4/5	02-11	1068-277-002	15158-35304
C104	Steel .082" 6.450" id 30T	direct clutch (B)	4/5	02-11	1068-377-019	15158-37604
C105	Steel .035" 6.450" id 30T (waved plate)	direct clutch (B)	1	02-11	n/a	15158-37704
D107	Friction .087" 7.370" od 30T	intermediate clutch (C)	4/5	02-11	1068-277-002	15158-35304
D108	Steel .118" 6.450" id 30T	intermediate clutch (C)	4/5	02-11	1068-377-020	15158-37504
D109	Steel .035" 6.450" id 30T (waved plate)	intermediate clutch (C)	1	02-11	n/a	15158-37704
D111	Steel .040" 6.450" id 30T (waved plate)	low/reverse clutch (D)	1	02-11	n/a	15158-37904
D112	Steel .082" 6.450" id 30T	low/reverse clutch (D)	6/7	02-11	1068-377-019	15158-37604
D112	Steel .095" 6.450" id 30T	low/reverse clutch (D)	sel	02-11	1068-377-022	15158-38204
D113	Friction .063" 7.370" od 30T	low/reverse clutch (D)	6/7	02-11	1068-277-004	15158-35204
PRESSURE PLATES						
A120	Pressure plate .105" 6.450" id 30T	forward clutch (A)	1	02-11	AE	15158-41103
B122	Pressure plate .118" 4.200" id 24T/24 tabs	overdrive clutch (E)	1	02-11	AE	15158-41603
C124	Pressure plate .152" 6.450" 30T/30 tabs	direct clutch (B)	1	02-11	AE	15158-42003
D126	Pressure plate 30T	intermediate clutch (C)	1	02-11	AE	15158-42203
D128	Pressure plate .142" 6.450" 30T	low/reverse clutch (D)	1	02-11	AE	15158-43003
D128	Pressure plate .130" 6.450" 30T	low/reverse clutch (D)	sel	02-11	AE	15158-42303
D128	Pressure plate .095" 6.450" 30T	low/reverse clutch (D)	sel	02-11	AE	15158-42503

ZF6HP26A•09E

ZF6HP26A•09E

ILL	DESCRIPTION		QTY	YEAR	REFERENCE #	PART #
FILTERS						
H135	Filter (6 sided not equal)	ZF6HP26A	1	02-11	0501-213-359	15158-45104
BUSHINGS						
A140	Bushing	stator (front)	1	02-11	n/a	15158-50704
A141	Bushing	stator (rear)	1	02-11	n/a	15158-50804
A142	Bushing	forward housing (front)	1	02-11	n/a	15158-50904
A144	Bushing	forward housing (rear)	1	02-11	n/a	15158-51204
B146	Bushing	overdrive housing (rear)	1	02-11	n/a	15158-51404
C148	Bushing	forward hub (front)	1	02-11	n/a	15158-51604
C149	Bushing	forward hub (rear)	1	02-11	n/a	15158-51604
C151	Bushing	direct housing (front)	1	02-11	n/a	15158-52204
C152	Bushing	direct housing (rear)	1	02-11	n/a	15158-52204
D154	Bushing	intermediate clutch housing (center)	1	02-11	n/a	15158-52304
E156	Bushing	output shaft (front)	1	02-11	n/a	15158-52504
WASHERS/BEARINGS/RACES/SHIMS						
A170	Bearing, caged	pump body	1	02-11	n/a	15158-56104
A171	Spacer, shim .133" 1.596" id 1.928" od	pump stator to front sun gear	1	02-11	n/a	15158-56204
B172	Bearing, thrust .161" 1.381" id 2.037" od	sun gear to race	1	02-11	n/a	15158-56504
B174	Race, thrust .030" 1.367" id 1.904" od	bearing to forward planetary	1	02-11	n/a	15158-57004
B175	Bearing, thrust .161" 1.381" id 2.037" od	race to overdrive housing	1	02-11	n/a	15158-56504
B176	Washer (retainer) .043" 1.38" id 1.702" od	od bal piston to snap ring	1	02-11	n/a	15158-57504
B177	Bearing, thrust .185" .834" id 1.504" od	overdrive housing to od hub	1	02-11	n/a	15158-57804
C179	Bearing, thrust .161" 1.381" id 2.037" od	overdrive hub to forward hub	1	02-11	n/a	15158-56504
C180	Race .038" 1.441" id 2.209" od	forward hub to bearing	1	02-11	n/a	15158-58304
C181	Bearing, thrust .155" 1.384" id 2.254" od	race to direct housing	1	02-11	n/a	15158-58504
C183	Washer (retainer) .080" 1.97" id 2.34" od	snap ring to diaphragm spring	1	02-11	n/a	15158-58804
C185	Bearing, thrust .135" 1.930" id 2.628" od	direct housing to race	1	02-11	n/a	15158-59004
C186	Race .032" 2.073" id 2.622" od	bearing to intermediate housing	1	02-11	n/a	15158-59204
D190	Bearing, thrust .136" 1.860" id 2.670" od	intermediate housing to race	1	02-11	n/a	15158-59604
E191	Race .042" 2.003" id 2.819" od	bearing to sun gear	1	02-11	n/a	15158-59704
E192	Race .125" 1.380" id 1.970" od	rear (front) sun gear to bearing	1	02-11	n/a	15158-60104
E193	Bearing, thrust .0154" 1.342" id 2.046" od	race to rear sun gear	1	02-11	n/a	15158-60504
E194	Bearing, thrust .0154" 1.342" id 2.046" od	race to rear sun gear	1	02-11	n/a	15158-60504
E195	Race .038" 1.333" id 1.902" od	bearing to rear planetary	1	02-11	n/a	15158-60604
E197	Bearing, thrust .155" 1.579" id 2.187" od	rear planetary to output shaft	1	02-11	n/a	15158-60904
E198	Race .038" 1.701" id 2.321" od	rear planetary to output shaft	1	02-11	n/a	15158-61004
SNAP RINGS						
A247	Snap ring .056" 3.0" od 4 tabs (true-arc)	fwd balance piston to diaphragm spring	1	02-11	AE	15158-62303
A248	Snap ring .155" 7.783" od	forward clutch pressure plate	1	02-11	AE	15158-62503
B250	Snap ring .038" 2.900" (waved)	forward hsg to forward/front planetary	1	02-11	AE	15158-62903
B251	Snap ring .095" 1.633" od	od balance piston retainer to od hsg	1	02-11	AE	15158-63303
B252	Snap ring .083" 5.584" od	overdrive clutch pressure plate	1	02-11	AE	15158-63603
C254	Snap ring .099" 7.750" od	direct hub to forward housing	1	02-11	AE	15158-63803
C255	Snap ring .138" 7.750" od	direct clutch pressure plate	1	02-11	AE	15158-64203
C256	Snap ring .056" 2.250" od	inside direct balance piston	1	02-11	AE	15158-64603
C257	Snap ring .096" 2.130" od	direct balance piston to diaphragm spring	1	02-11	AE	15158-64803
D259	Snap ring .181" (beveled both sides)	8.500" od (intermediate housing to case)	1	02-11	AE	15158-65103
D260	Snap ring .123" 7.750" od	intermediate clutch pressure plate	1	02-11	AE	15158-65403
D261	Snap ring .075" 3.700" od	intermediate clutch retainer	1	02-11	AE	15158-65703
E263	Snap ring .076" 7.250" od	output shaft to rear ring gear	1	02-11	AE	15158-66003
PUMP PARTS AND PUMPS						
A280	Pump assembly	ZF6HP26A	1	02-11	AE	40280-67003

ILL	DESCRIPTION	QTY	YEAR	REFERENCE #	PART #	
HARD PARTS						
A290	Housing, forward clutch	ZF6HP26A	1	02-11	AE	15158-72203
A291	Piston, forward clutch	ZF6HP26A	1	02-11	AE	15158-72603
A292	Spring, diaphragm .082" 10 fingers	forward clutch	1	02-11	AE	15158-72803
A293	Piston, forward clutch (balance)	ZF6HP26A	1	02-11	AE	15158-73203
B295	Gear, forward sun	ZF6HP26A	1	02-11	AE	40280-73503
B296	Planetary, forward	ZF6HP26A	1	02-11	AE	40280-73903
B297	Slinger, oil dam	4 tabs 4 oil tubes	1	02-11	1070-332-063	15158-74103
B300	Housing, od (w/turbine shaft ring gear)	bushing surface by splines 2 sealing rings	1	02-11	AE	15158-74503
B301	Piston, overdrive clutch 1.340" oh	ZF6HP26A	1	02-11	1068-471-037	15158-75003
B302	Spring, diaphragm .079" 10 fingers	overdrive clutch (4.489" od)	1	02-11	AE	15158-75203
B303	Piston, overdrive balance	ZF6HP26A	1	02-11	AE	15158-75403
C305	Hub, overdrive w/shaft	ZF6HP26A	1	02-11	AE	15158-75603
C306	Hub, overdrive w/shaft .925" od 29 splines	ZF6HP26A	1	02-11	AE	15158-75703
C307	Hub, direct clutch	ZF6HP26A	1	02-11	AE	15158-76103
C308	Spring, diaphragm .079" 10 fingers	4.865" od	1	02-11	AE	15158-76503
C309	Piston, balance direct clutch	ZF6HP26A	1	02-11	AE	15158-76703
C310	Piston, direct clutch	ZF6HP26A	1	02-11	AE	15158-76903
C311	Housing, direct clutch 1.773" od	(56 splines)	1	02-11	AE	15158-77203
D313	Retainer, intermediate clutch	ZF6HP26A	1	02-11	AE	15158-77503
D314	Spring, diaphragm .082" 6.948" od	12 fingers	1	02-11	AE	15158-77803
D315	Piston, intermediate clutch	ZF6HP26A	1	02-11	AE	15158-78203
D316	Housing, intermediate clutch	ZF6HP26A	1	02-11	AE	15158-78703
D317	Piston, low/reverse clutch	ZF6HP26A	1	02-11	AE	15158-79203
D318	Piston, balance low/reverse clutch	ZF6HP26A	1	02-11	AE	15158-79503
D319	Spring, diaphragm .063" 12 fingers	5.694" od (low/reverse clutch)	1	02-11	AE	15158-79603
D320	Retainer, 2 piece (split type)	low/reverse (large)	1	02-11	AE	15158-79803
D321	Retainer, 2 piece (split type w/2 tabs)	low/reverse (small)	1	02-11	AE	15158-79903
E325	Gear, rear front sun gear	ZF6HP26A	1	02-11	AE	40280-80103
E326	Gear, rear rear sun gear	ZF6HP26A	1	02-11	AE	40280-80503
E327	Planetary, rear	ZF6HP26A	1	02-11	AE	40280-81003
E328	Gear, output ring	ZF6HP26A	1	02-11	AE	40280-81503
E329	Shaft, output	ZF6HP26A	1	02-11	AE	40280-82303
ELECTRICAL COMPONENTS						
n/i	Kit, solenoid (7) manual shift	1-black/3-yellow/3-blue	1	02-11	1068-298-044	45158-85004
n/i	Kit, solenoid (7) manual shift	5-yellow/1-black/1-blue	1	02-11	1068-298-045	45158-85104
n/i	Kit, solenoid (9) electric shift	1-MV2-green/3-yellow/1-black/3-blue	1	02-11	1068-298-043	45158-85204
H383	Solenoid, shift (green connector)	MV3 w/electric shift	1	02-11	n/a	45158-86004
H400	Solenoid	MV2 w/electric shift (on opposite side)	1	02-11	n/a	45158-86404
H401	Solenoid (PWM)(yellow connector)	EDS6	1	02-11	0501-213-960	45158-85404
H402	Solenoid (on/off)(black connector)	MV1	1	02-11	0501-319-037	45158-85604
H403	Solenoid (PWM)(blue connector)	EDS4	1	02-11	0501-213-959	45158-85804
H404	Solenoid (PWM)(blue connector)	EDS5	1	02-11	0501-213-959	45158-85804
H405	Solenoid (PWM)(yellow connector)	EDS3	1	02-11	0501-213-960	45158-85404
H406	Solenoid (PWM)(blue connector)	EDS2	1	02-11	0501-213-959	45158-85804
H407	Solenoid (PWM)(yellow connector)	EDS1	1	02-11	0501-213-960	45158-85404
H408	Solenoid, park/manual valve	w/electric shift	1	02-11	n/a	45158-88104
H409	Solenoid, shift (green connector)	MV3 w/electric shift	1	02-11	n/a	45158-86004
H411	TCM (transmission control module)	ZF6HP26A	1	02-11	n/a	45158-86504
H411	TCM (transmission control module)	w/electric shift	1	02-11	n/a	45158-86604
H412	Harness, wiring	w/electric shift	1	02-11	n/a	45158-87504
n/i	Connector, case electrical	ZF6HP26A	1	02-11	n/a	45158-90104
NOTES						

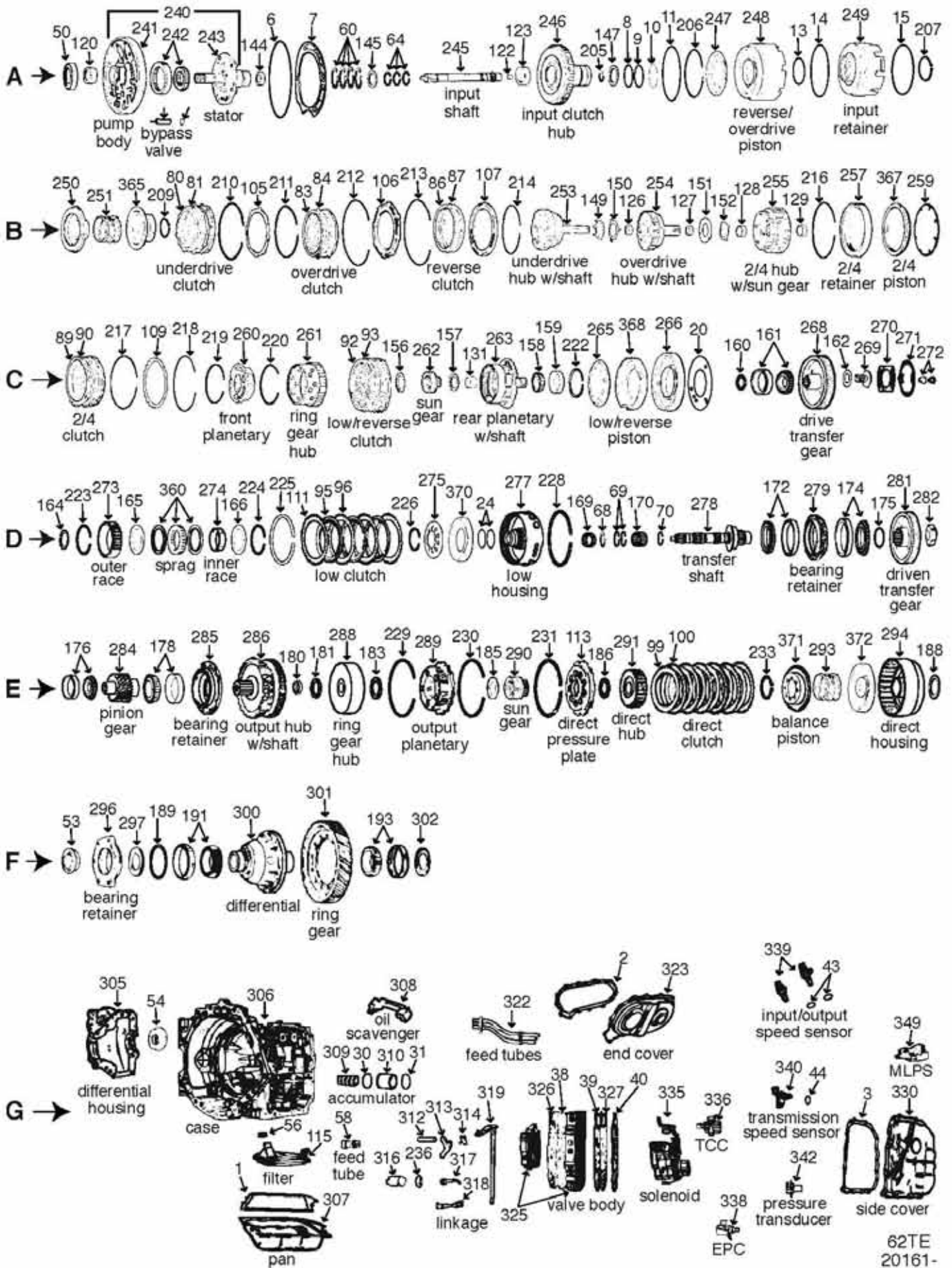

ILL	DESCRIPTION	QTY	YEAR	REFERENCE #	PART #
TECHNICAL MANUALS					
K53	Tech manual 62TE dis-assembly	1	06-10	n/a	010-125
REBUILDER KITS					
K5	Master kit w/steels	1	06-10	AE	20161-11004
K5	Master kit w/steels	1	06-10	AE	20161-11104
K6	Master kit w/o steels	1	06-10	AE	20161-12004
K6	Master kit w/o steels	1	06-10	AE	20161-12104
K7	O/H gasket set w/seals-rings	1	06-10	AE	20161-13004
K7	O/H gasket set w/seals-rings	1	06-10	2541	20161-13104
GASKETS AND RUBBER COMPONENTS					
G1	Gasket, bottom pan	1	06-10	n/a	20161-19004
G2	Gasket, end cover	1	06-10	n/a	20161-19204
G3	Gasket, side cover	1	06-10	n/a	20161-19404
A6	Seal, lathe cut	1	06-10	5205660	13721
A7	Gasket, pump to case	1	06-10	n/a	20161-28204
A8	O'ring .103" (blue)	1	06-10	6502271	23805
A9	O'ring .103" (red)	1	06-10	6502269	23806
A10	Lip seal	1	06-10	4659319	23195
A11	Lip seal	1	06-10	4659056	23875
A15	Lip seal	1	06-10	4377173	23221
METAL CLAD SEALS					
A50	Seal, metal clad	1	06-10	B37097	20161-30104
F53	Seal, metal clad 2.290x1.510x.354"	2	06-10	B29952	48576
SEALING RINGS					
K10	Kit, sealing ring	1	06-10	3528	20161-31504
A60	Ring, sealing (nickel plated)	4	06-10	4471874	49800
A64	Ring, sealing (teflon)	3	06-10	4446543	49801T
CLUTCH PLATES					
B80	Steel .067" 4.500" id 8T	4	06-10	4659053	49104
B81	Friction .071" 5.432" od 28T	4	06-10	4659635	49105
B83	Friction .071" 5.432" od 28T	4	06-10	4659635	49105
B84	Steel .078" 4.528" id 8T	3	06-10	68010495AA	20161-37704
B86	Friction .071" 5.432" od 28T	2	06-10	4659635	49105
B87	Steel .067" 4.500" id 8T	1	06-10	4659053	49104
C89	Steel .099" 5.255" id 16T	3	06-10	077703A-250	20161-37904
C89	Steel .067" 5.255" id 16T	1	06-10	077703A-170	20161-38004
C90	Friction .086" 6.065" od 31T	4	06-10	4567212	49107
C92	Friction .072" 6.063" od 32T	5	06-10	4377134	49103
C93	Steel .067" 5.255" id 16T	4	06-10	077703A-170	20161-38004
C93	Steel .099" 5.255" id 16T	1	06-10	077703A-250	20161-37904
D95	Friction .072" 4.773" od 29T	3	06-10	05078609AA	20161-35704
D96	Steel .068" 4.114" id 42T	3	06-10	68029389AA	20161-38404
E99	Friction .060" 4.467" od 29 internal teeth	6	06-10	05078628AA	20161-35404
E100	Friction .060" 3.634" id 30 external teeth	6	06-10	05078813AA	20161-35504
PRESSURE PLATES					
B105	Kit, pressure plate .217" w/snap ring	1	06-10	4723684	K49185
B105	Kit, pressure plate .236" w/snap ring	1	06-10	4723683	K49185A
B105	Kit, pressure plate .255" w/snap ring	1	06-10	4723682	K49185B
B105	Kit, pressure plate .275" w/snap ring	1	06-10	4723681	K49185C
B105	Pressure plate .217" w/o snap ring	1	06-10	AE	49185-R
B105	Pressure plate .236" w/o snap ring	1	06-10	AE	49185A-R
B105	Pressure plate .255" w/o snap ring	1	06-10	AE	49185B-R
B105	Pressure plate .275" w/o snap ring	1	06-10	AE	49185C-R
B106	Pressure plate (8 lug)	1	06-10	4377191	49191-R

ILL	DESCRIPTION	QTY	YEAR	REFERENCE #	PART #
PRESSURE PLATES (CONTINUED)					
B106	Pressure plate (4 lug) overdrive clutch	1	06-10	4531556	49191A-R
B107	Pressure plate reverse clutch	1	06-10	4377194	49194-R
C109	Pressure plate low/reverse clutch	1	06-10	4412265	49265-R
D111	Pressure plate low clutch	1	06-10	AE	20161-42303
E113	Pressure plate direct clutch	1	06-10	AE	20161-42703
FILTERS					
K9	Kit, filter 62TE	1	06-10	AE	20161-44004
G115	Filter 62TE	1	06-08	05078555AA	20161-45004
BUSHINGS					
K12	Kit, bushing 62TE	1	06-10	AE	K49905A
A120	Bushing (babbit) 38.113mm bore pump body	1	06-10	2466796	12502
A120	Bushing (bronze) pump body	1	06-10	2466796	12502A
A122	Bushing .603" od input shaft to underdrive hub	1	06-10	4412211AB	49002A
A123	Bushing input clutch hub to pump support	1	06-10	4377570	49003
B126	Bushing front overdrive hub	1	06-10	4659617	49004A
B127	Bushing rear overdrive hub	1	06-10	4659617	49004A
B128	Bushing 2/4 hub	1	06-10	4659619	49005A
C131	Bushing rear planetary	1	06-10	4412230	49006
WASHERS/BEARINGS/RACES/SHIMS					
K13	Kit, thrust washer 62TE	1	06-10	AE	20161-54504
K13	Kit, thrust bearing 62TE	1	06-10	AE	20161-55104
A144	Bearing, thrust rear pump stator	1	06-10	n/a	20161-56404
A145	Bearing, thrust stator to input clutch hub	1	06-10	4412209	49633
A147	Bearing, thrust input clutch hub to underdrive clutch hub	1	06-10	4567262	49635
B149	Thrust washer (5 tabs) underdrive clutch hub to race	1	06-10	4471855	49625
B150	Race (3 tabs) overdrive hub to 2/4 hub	1	06-10	4431973	49621
B151	Race .093-1.00mm (3 slots) overdrive clutch hub to thrust washer	sel	06-10	4331662	49622
B151	Race 1.37-1.44mm (3 slots) overdrive clutch hub to thrust washer	sel	06-10	4431664	49622A
B151	Race 1.81-1.88mm (3 slots) overdrive clutch hub to thrust washer	sel	06-10	4431666	49622B
B151	Race 2.25-2.32mm (3 slots) overdrive clutch hub to thrust washer	sel	06-10	4431668	49622C
B151	Race 2.47-2.54mm (3 slots) overdrive clutch hub to thrust washer	sel	06-10	4431669	49622D
B151	Race 2.91-2.98mm (3 slots) overdrive clutch hub to thrust washer	sel	06-10	44316711	49622E
B151	Race 3.25-3.42mm (3 slots) overdrive clutch hub to thrust washer	sel	06-10	4446601	49622F
B152	Thrust washer (4 tabs) race to 2nd/4th clutch hub	1	06-10	4412216	49627
C156	Bearing, thrust front planetary to rear sun gear	1	06-10	4412229AB	49638
C157	Bearing, thrust rear sun gear to rear planetary	1	06-10	4567262	49635
C158	Bearing, tapered (cone) 36mm id rear planetary	1	06-10	4504013	48761
C159	Race, tapered (cup) rear planetary	1	06-10	4446689	48762
C160	Washer, spacer (shim) transfer gear to rear planetary	sel	06-10	n/a	20161-56904
C161	Bearing, cup/cone drive transfer gear	1	06-10	AE	20161-57004
C162	Washer drive gear to bolt	1	06-10	6501832	49629
D164	Bearing, thrust inner sprag race	1	06-10	n/a	20161-57204
D165	Bearing, thrust outer sprag race	1	06-10	n/a	20161-57404
D166	Bearing, thrust low housing to sprag	1	06-10	n/a	20161-57604
D169	Bearing, caged transfer shaft	1	06-10	n/a	20161-57804
D170	Bearing, caged transfer shaft	1	06-10	n/a	20161-57804
D172	Bearing, cup/cone bearing retainer	1	06-10	n/a	20161-58004
D174	Bearing, cup/cone bearing retainer	1	06-10	n/a	20161-58204
E176	Bearing, cup/cone pinion gear	1	06-10	n/a	20161-58404
E178	Bearing, cup/cone pinion gear	1	06-10	n/a	20161-58604
E181	Bearing, thrust output hub to ring gear	1	06-10	n/a	20161-58804
E183	Bearing, thrust ring gear to planetary	1	06-10	n/a	20161-58904
E185	Bearing, thrust sun gear to ring gear	1	06-10	n/a	20161-59004

ILL	DESCRIPTION	QTY	YEAR	REFERENCE #	PART #
WASHERS/BEARINGS/RACES/SHIMS (CONTINUED)					
E186	Bearing, thrust	1	06-10	n/a	20161-59204
E188	Bearing, thrust	1	06-10	n/a	20161-59402
F191	Bearing, cup/cone	1	06-10	n/a	20161-59604
F193	Bearing, cup/cone	1	06-10	n/a	20161-59804
SNAP RINGS					
K14	Kit, snap ring	8 pieces	1	06-10	77681A K49321A
A205	Snap ring .061" 1.030" od (round wire)	input shaft in input clutch hub	1	06-10	6501702 49321
A206	Snap ring .060" 5.326" od	reverse/overdrive piston	1	06-10	4412203 49322
A207	Snap ring .095" 2.594" od (tru-ark)	input retainer	1	06-10	6507226AA 49323
B209	Snap ring .077" 2.285" od (tru-ark)	underdrive retainer	1	06-10	6501715 49324
B210	Snap ring .060" 5.956" od	underdrive clutch	sel	06-10	4412307 49310C
B211	Snap ring .065" 6.875" od waved (blue)	overdrive clutch	sel	06-10	4531411 49310A
B211	Snap ring .075" 6.330" od (turquoise)	overdrive clutch	sel	06-10	4567602 49310B
B212	Snap ring .061" 6.875" od	overdrive clutch	1	06-10	65015621 49326
B213	Snap ring .069"	reverse clutch	1	06-10	4531411 49327
B214	Snap ring .090" 4.720" od	reverse clutch	1	06-10	4412873 49328
B216	Snap ring .061" 7.010" od	2/4 retainer	1	06-10	4505591 49329
C217	Snap ring .068" 7.010" od	2/4 clutch	1	06-10	4799858AA 49330
C218	Snap ring .040"	2/4 pressure plate	1	06-10	4412395 49331
C219	Snap ring .062" 4.719" od	front planetary	1	06-10	6035238 49332
C220	Snap ring .062" 4.719" od	front planetary	1	06-10	6035238 49332
C222	Snap ring .090" 3.487" od	low/reverse retainer	1	06-10	4412873 49334
D223	Snap ring	hold sprag in outer race	1	06-10	n/a 20161-62103
D224	Snap ring	hold sprag in outer race	1	06-10	n/a 20161-62103
D225	Snap ring	low clutch pressure plate	1	06-10	n/a 20161-62603
D226	Snap ring	low clutch retainer	1	06-10	n/a 20161-63003
D228	Snap ring	low clutch housing	1	06-10	n/a 20161-63403
E229	Snap ring	output planetary	1	06-10	n/a 20161-63703
E230	Snap ring	output planetary	1	06-10	n/a 20161-63803
E231	Snap ring	direct pressure plate	1	06-10	n/a 20161-64003
E233	Snap ring	direct clutch retainer	1	06-10	n/a 20161-64203
G236	Snap ring	park guide	6	07-10	AE 20161-63103
PUMP PARTS AND PUMPS					
A240	Pump assembly	62TE	1	06-10	AE 20161-67003
A241	Body, pump w/gears	62TE	1	06-10	AE 20161-67503
A242	Gears, pump	62TE	1	06-10	AE 20161-68104
A243	Stator, pump	62TE	1	06-10	AE 20161-68503
HARD PARTS					
A247	Spring, diaphragm	overdrive/reverse clutch	1	06-10	4412202 49745-R
A245	Shaft, input	turbine shaft	1	07-10	AE 20161-72103
A246	Hub, input clutch	62TE	1	07-10	AE 20161-72303
A247	Spring, diaphragm	62TE	1	06-10	4412202 49745-R
A248	Piston, reverse/overdrive housing	62TE	1	07-10	AE 20161-72503
A249	Retainer, input housing	62TE	1	07-10	AE 20161-72703
B250	Piston, underdrive .550"	62TE	1	06-10	4431611 49739
B251	Spring, return	underdrive clutch	1	07-10	AE 20161-73103
B253	Hub, underdrive w/shaft	62TE	1	07-10	n/a 20161-73204
B253	Hub, underdrive w/shaft	62TE	1	07-10	AE 20161-73203
B254	Hub, overdrive w/shaft	62TE	1	07-10	n/a 20161-73404
B254	Hub, overdrive w/shaft	62TE	1	07-10	AE 20161-73403
B255	Hub, 2/4 clutch w/sun gear	62TE	1	07-10	n/a 20161-73604
B255	Hub, 2/4 clutch w/sun gear	62TE	1	07-10	AE 20161-73603
B257	Retainer, 2/4 clutch housing	62TE	1	07-10	AE 20161-73803

ILL	DESCRIPTION	QTY	YEAR	REFERENCE #	PART #	
HARD PARTS (CONTINUED)						
B259	Spring, diaphragm	62TE	1	07-10	AE	49746-R
C260	Planetary, front	62TE	1	07-10	n/a	20161-74204
C260	Planetary, front	62TE	1	07-10	AE	20161-74203
C261	Gear, front ring	62TE	1	07-10	n/a	20161-74504
C261	Gear, front ring	62TE	1	07-10	AE	20161-74503
C262	Gear, rear sun	62TE	1	07-10	n/a	20161-74704
C262	Gear, rear sun	62TE	1	07-10	AE	20161-74703
C263	Planetary, rear w/shaft	62TE	1	07-10	n/a	20161-75004
C263	Planetary, rear w/shaft	62TE	1	07-10	AE	20161-75003
C265	Spring, diaphragm	62TE	1	07-10	AE	49747-R
C266	Retainer, low/reverse	62TE	1	07-10	AE	20161-75304
C268	Gear, transfer drive	62TE	1	07-10	AE	20161-75503
C269	Bolt, transfer gear to planetary	62TE	1	07-10	AE	20161-75803
C270	Plate, transfer drive gear	62TE	1	07-10	AE	20161-75903
C271	Plate, transfer drive gear	62TE	1	07-10	AE	20161-76003
C272	Bolt, transfer plate support	62TE	2	07-10	AE	20161-76103
D273	Race, outer sprag	62TE	1	07-10	AE	20161-76203
D274	Race, inner sprag	62TE	1	07-10	AE	20161-76303
D275	Spring, diaphragm	low clutch return	1	07-10	AE	20161-76503
D277	Housing, low clutch	62TE	1	07-10	AE	20161-76703
D278	Shaft, transfer	62TE	1	07-10	AE	20161-76903
D279	Retainer, bearing transfer gear	62TE	1	07-10	AE	20161-77103
D281	Gear, transfer driven	62TE	1	07-10	AE	20161-77203
D282	Nut, transfer driven gear	62TE	1	07-10	AE	20161-77503
E284	Gear, pinion	62TE	1	07-10	AE	20161-77803
E285	Retainer, bearing output hub	62TE	1	07-10	AE	20161-78003
E286	Hub, output w/shaft	park gear	1	07-10	AE	20161-78203
E288	Gear, output planetary ring	62TE	1	07-10	AE	20161-78503
E289	Planetary, output	62TE	1	07-10	AE	20161-78703
E290	Gear, output sun	62TE	1	07-10	AE	20161-78903
E291	Hub, direct clutch	62TE	1	07-10	AE	20161-79103
E293	Spring, direct clutch return	62TE	1	07-10	AE	20161-79303
E294	Housing, direct clutch	62TE	1	07-10	AE	20161-79503
F296	Retainer, bearing differential	62TE	1	07-10	AE	20161-79703
F297	Plate, differential bearing	62TE	1	07-10	AE	20161-79803
F300	Differential, w/spider gears	62TE	1	07-10	AE	20161-80103
F301	Gear, ring	62TE	1	07-10	AE	20161-80403
F302	Plate, differential bearing	62TE	1	07-10	AE	20161-80703
G305	Housing, differential cover	62TE	1	07-10	AE	20161-81003
G306	Case, main	62TE	1	07-10	AE	20161-81203
G307	Pan, bottom	62TE	1	07-10	AE	20161-81503
G308	Scavenger, oil	62TE	1	07-10	AE	20161-81603
G309	Spring, accumulator	62TE	6	07-10	AE	20161-81703
G310	Piston, accumulator	62TE	6	07-10	AE	20161-81803
G312	Pin, park pawl	62TE	1	07-10	AE	20161-82003
G313	Pawl, park	62TE	1	07-10	AE	20161-82103
G314	Spring, park pawl	62TE	1	07-10	AE	20161-82203
G316	Guide, park rod	62TE	1	07-10	AE	20161-82303
G318	Spring, detent w/roller	62TE	1	07-10	AE	20161-82503
G319	Shaft, manual shift	62TE	1	07-10	AE	20161-82603
G323	Pan, side cover	62TE	1	07-10	AE	20161-82703
G325	Body, valve	62RE	1	07-10	AE	20161-83003
G330	Pan, side cover	62TE	1	07-10	AE	20161-83503

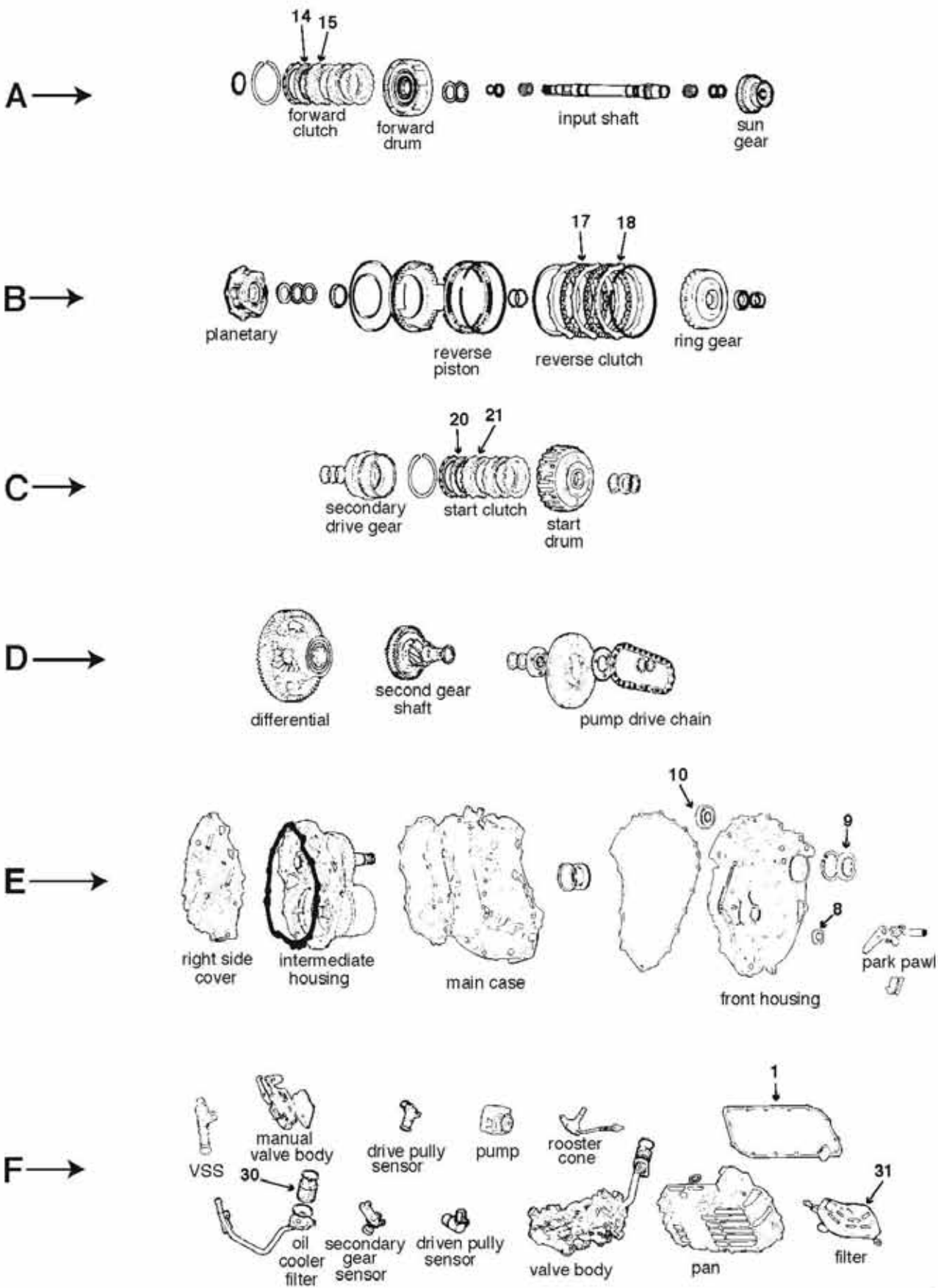

M4VA
50000Z

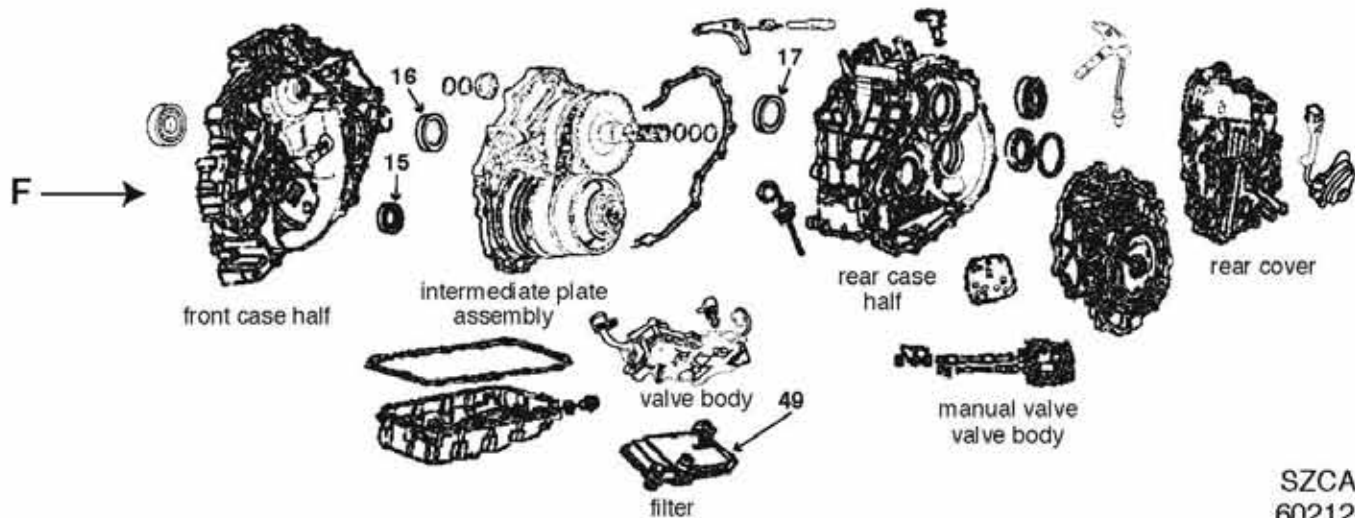
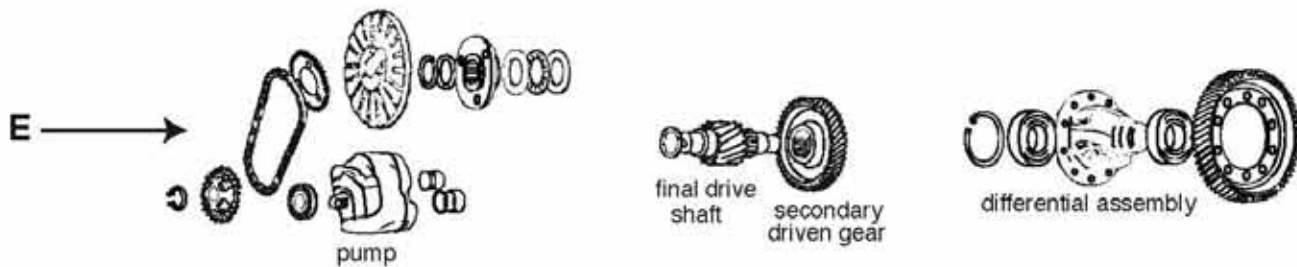
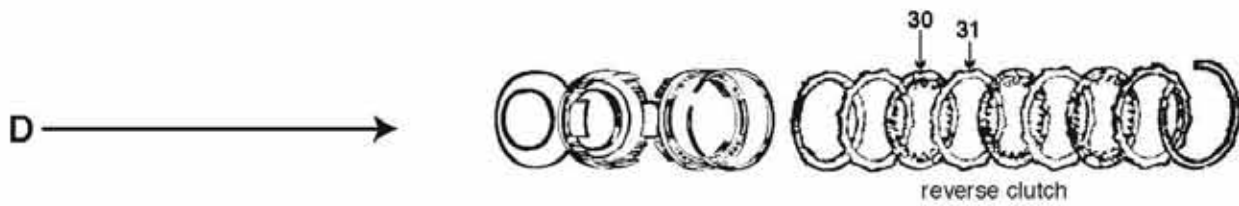
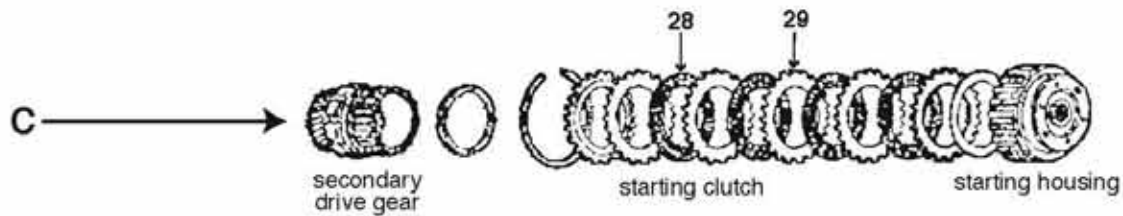
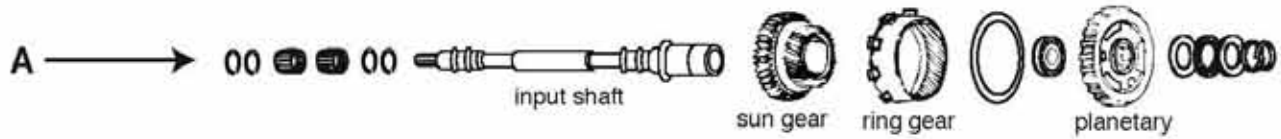

SZCA
60212-

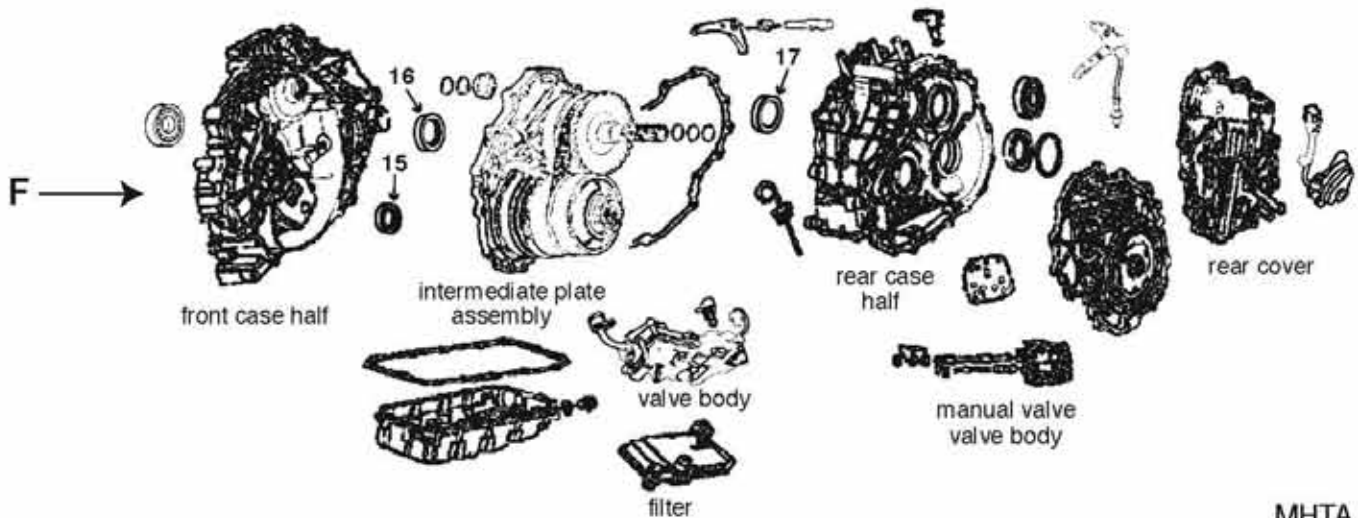
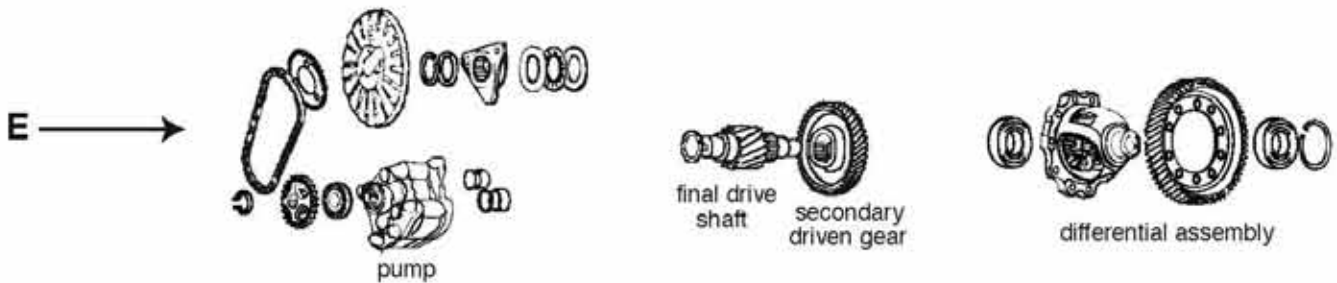
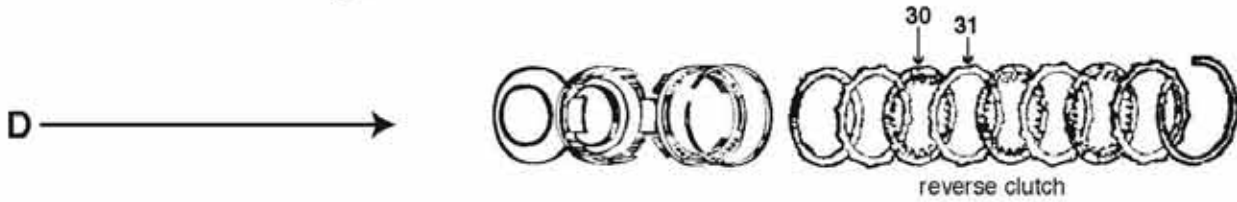
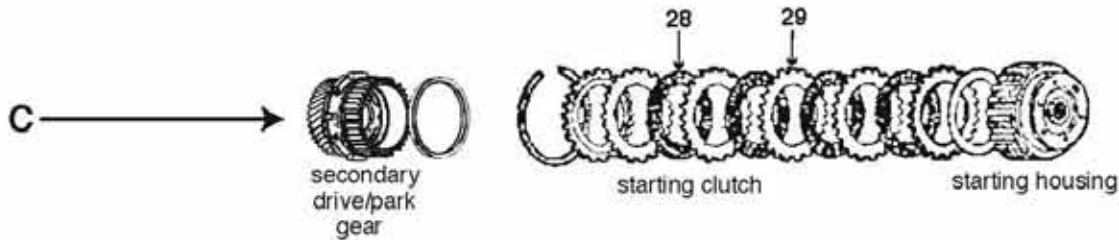
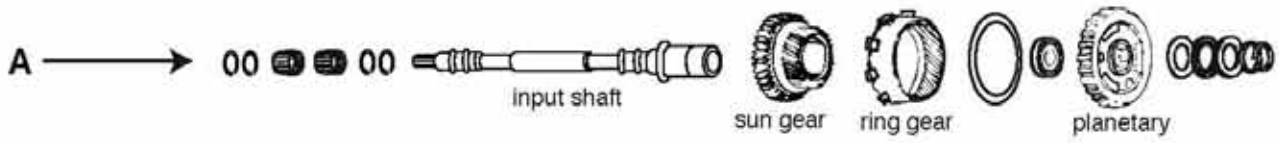

MHTA
60200-

ILL	DESCRIPTION		QTY	YEAR	REFERENCE #	PART #
REBUILDER KITS						
K5	Master kit w/steels	MHTA	1	01-07	n/a	60200-11104
K6	Master kit w/o steels	MHTA	1	01-07	n/a	60200-12104
K7	O/H gasket set w/seals-rings	MHTA	1	01-07	APC-118804	60200-13104
METAL CLAD SEALS						
F15	Seal, metal clad	converter housing	1	01-07	91207-PWR-003	60212-30000
F16	Seal, metal clad	right axle	1	01-07	91205-PZ5-003	60200-30200
F17	Seal, metal clad	left axle	1	01-07	91206-PL6-003	60200-30100
CLUTCH PLATES						
B25	Friction .075" 4.323" od 38T (110mm)	forward clutch	2	01-07	22544-PZ4-J00	50103D
B26	Steel .079" 3.230" id 8T (80mm)	forward clutch	2	01-07	22543-PC9-000	50100D
C28	Friction .075" 4.570" od 41T (116mm)	low clutch (starting clutch)	4	01-07	22544-PF4-010	50103E
C29	Steel .091" 3.440" id 24T	low clutch (starting clutch)	5	01-07	058723-230	50113A
D30	Friction .079" 5.173" od 24T	reverse brake clutch	2	01-07	22545-P4V-013	50159
D31	Steel .053" 5.161" id 12T	reverse brake clutch	2	01-07	22544-P4V-003	50168A
FILTERS						
F49	Filter, oil sreen	MTHA	1	01-07	25420-PHT-003	60200-45004
n/i	Filter, cooler line (cartridge type)	MTHA	1	01-07	25450-P4V-013	50711
NOTES						

MHTA

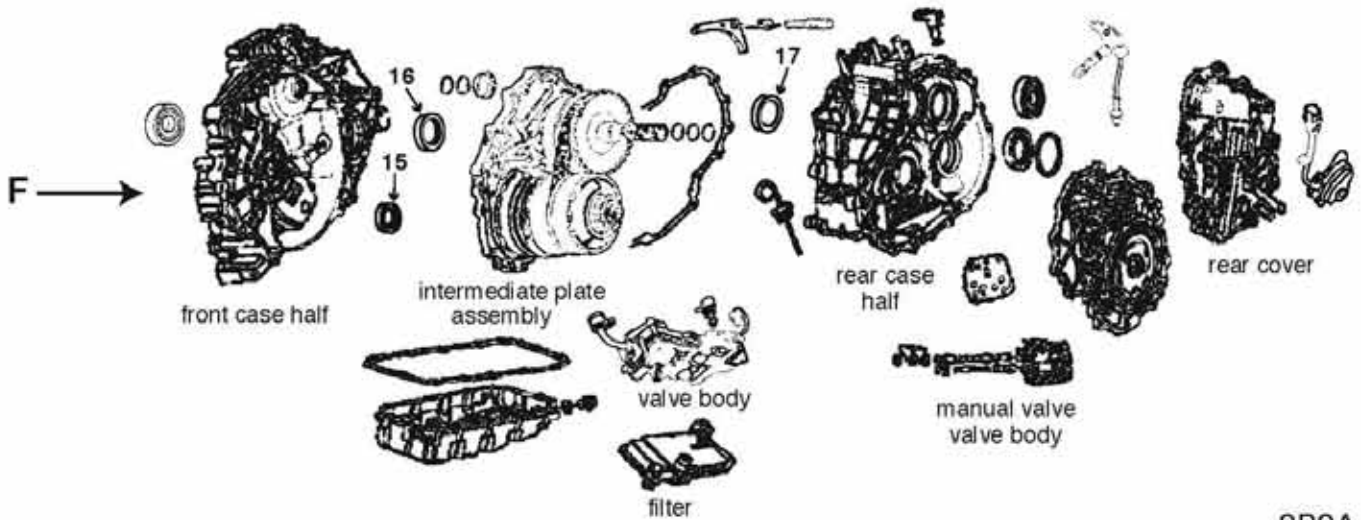
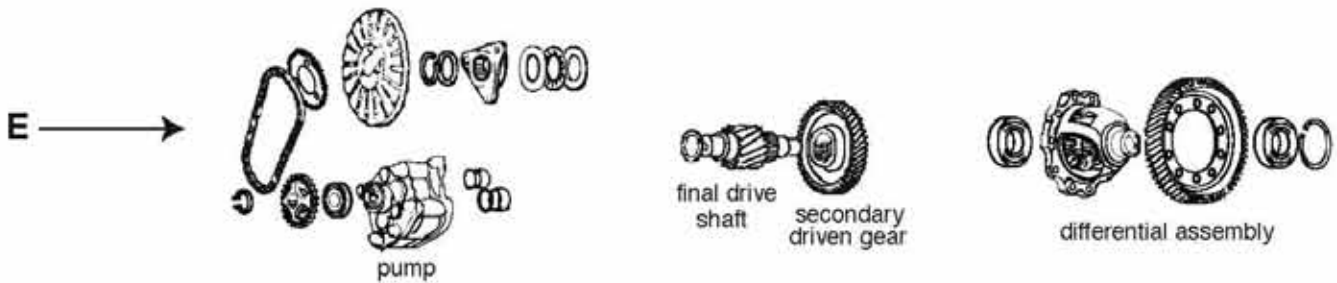
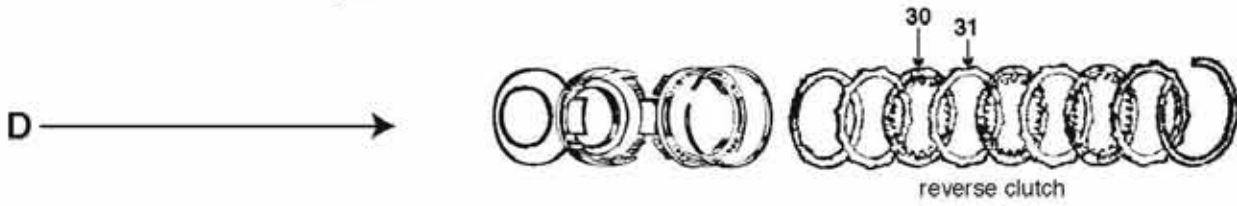
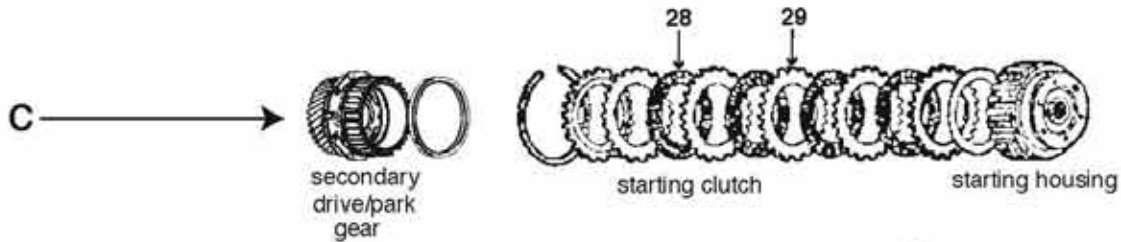
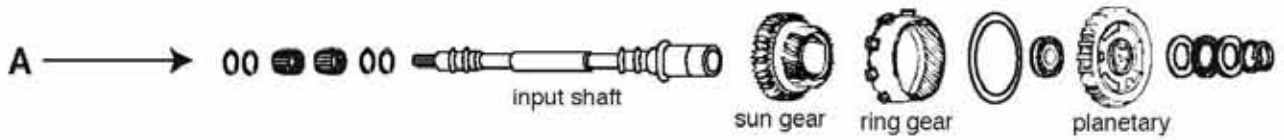

SPSA
60209-

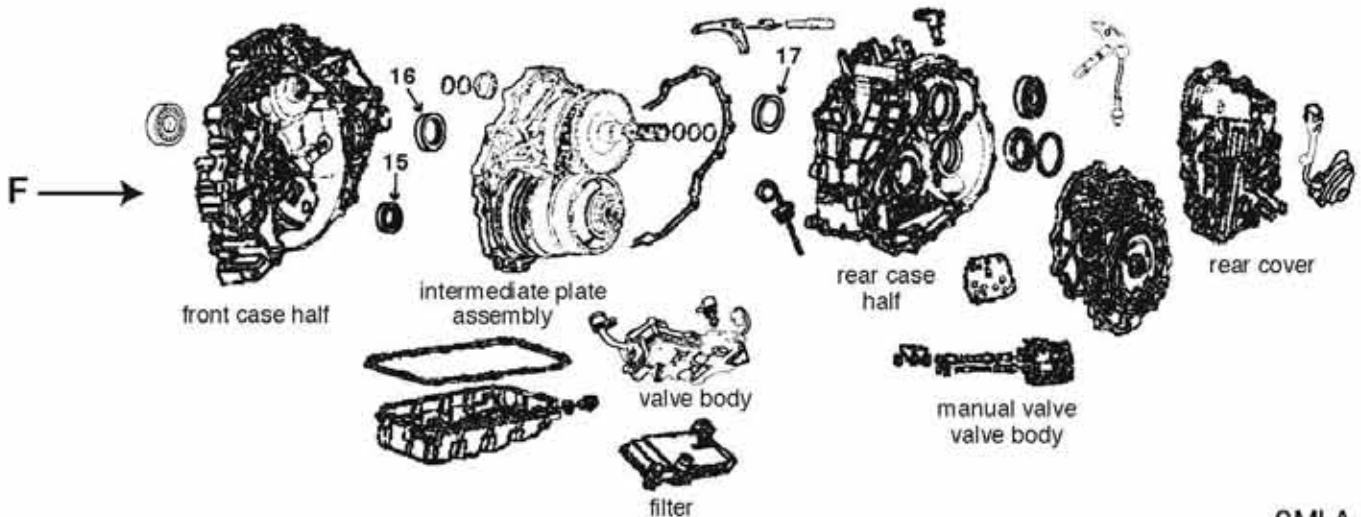
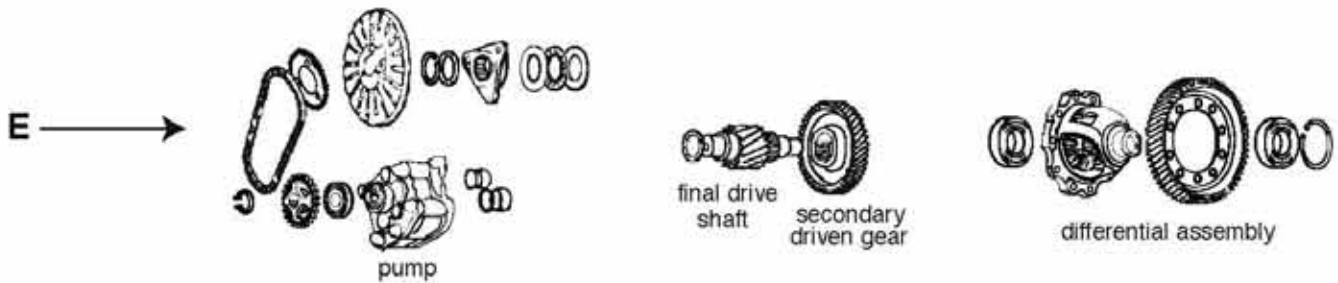
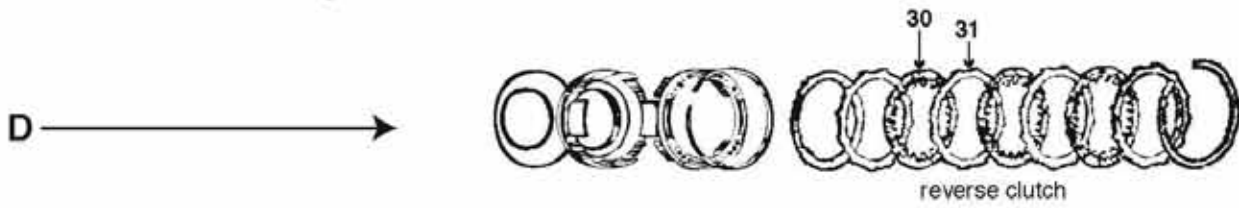
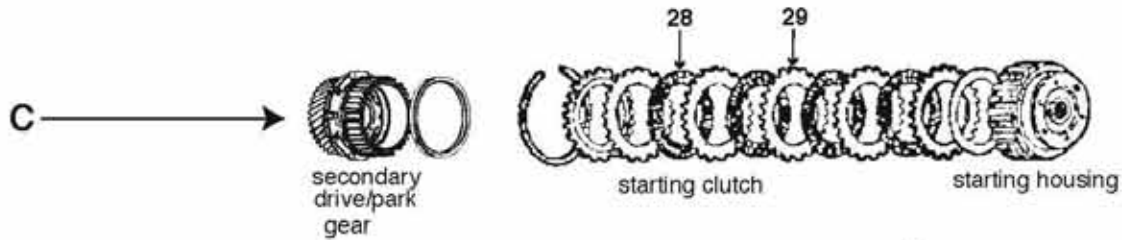
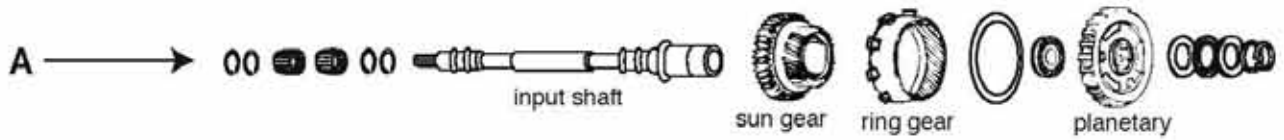

SMLA
60210-

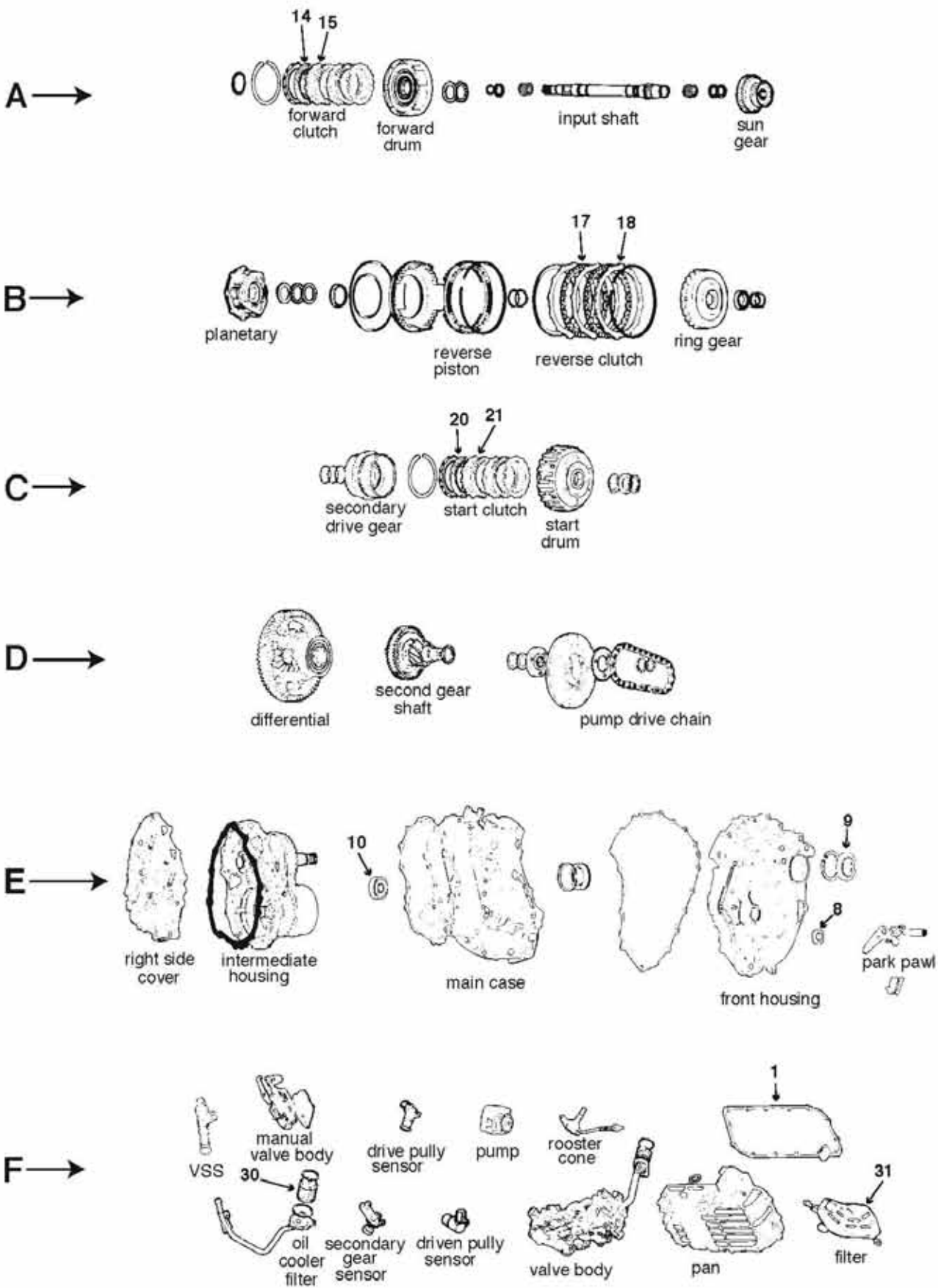

MLYA
60255-

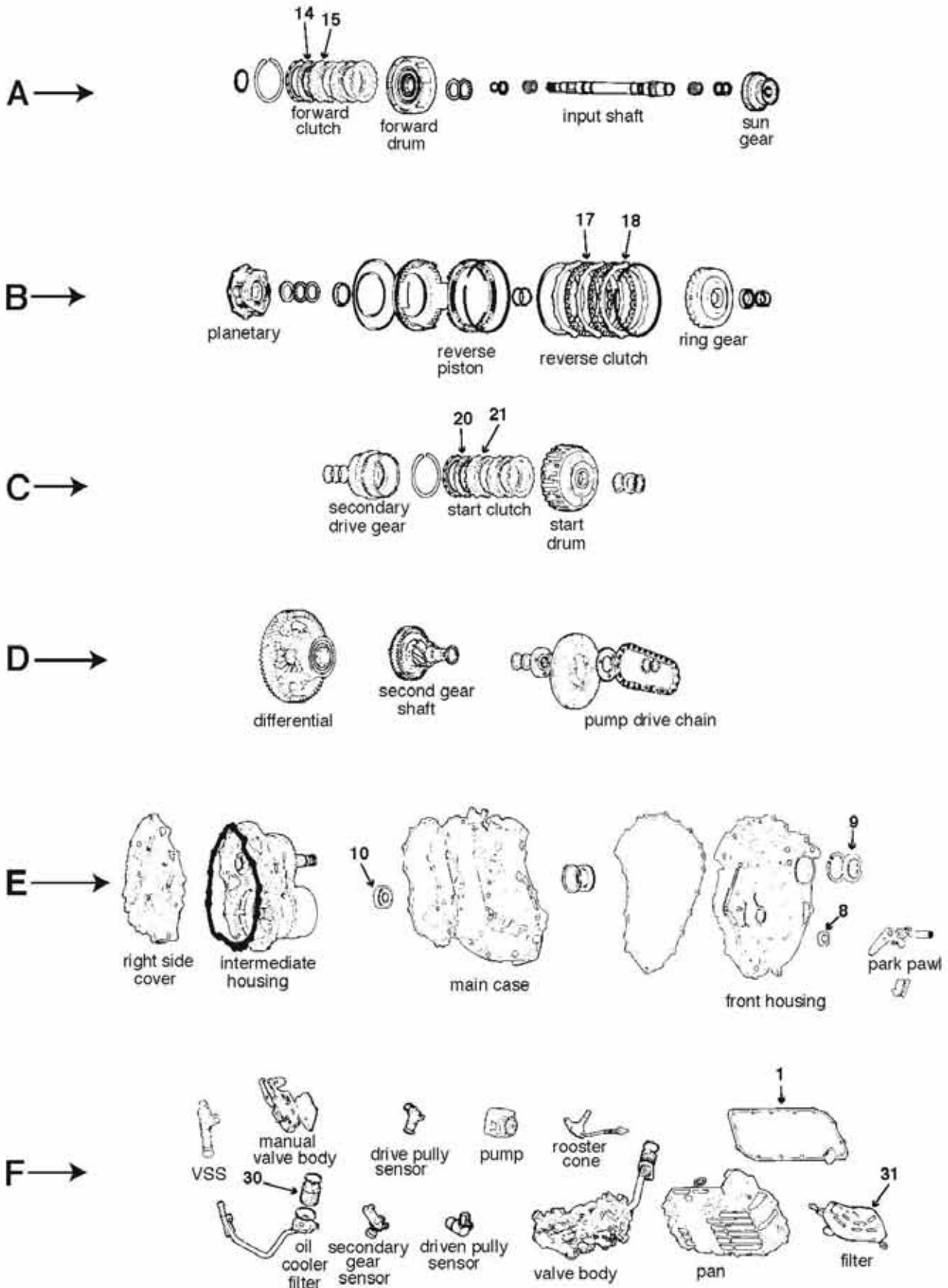

SLYA
60256-

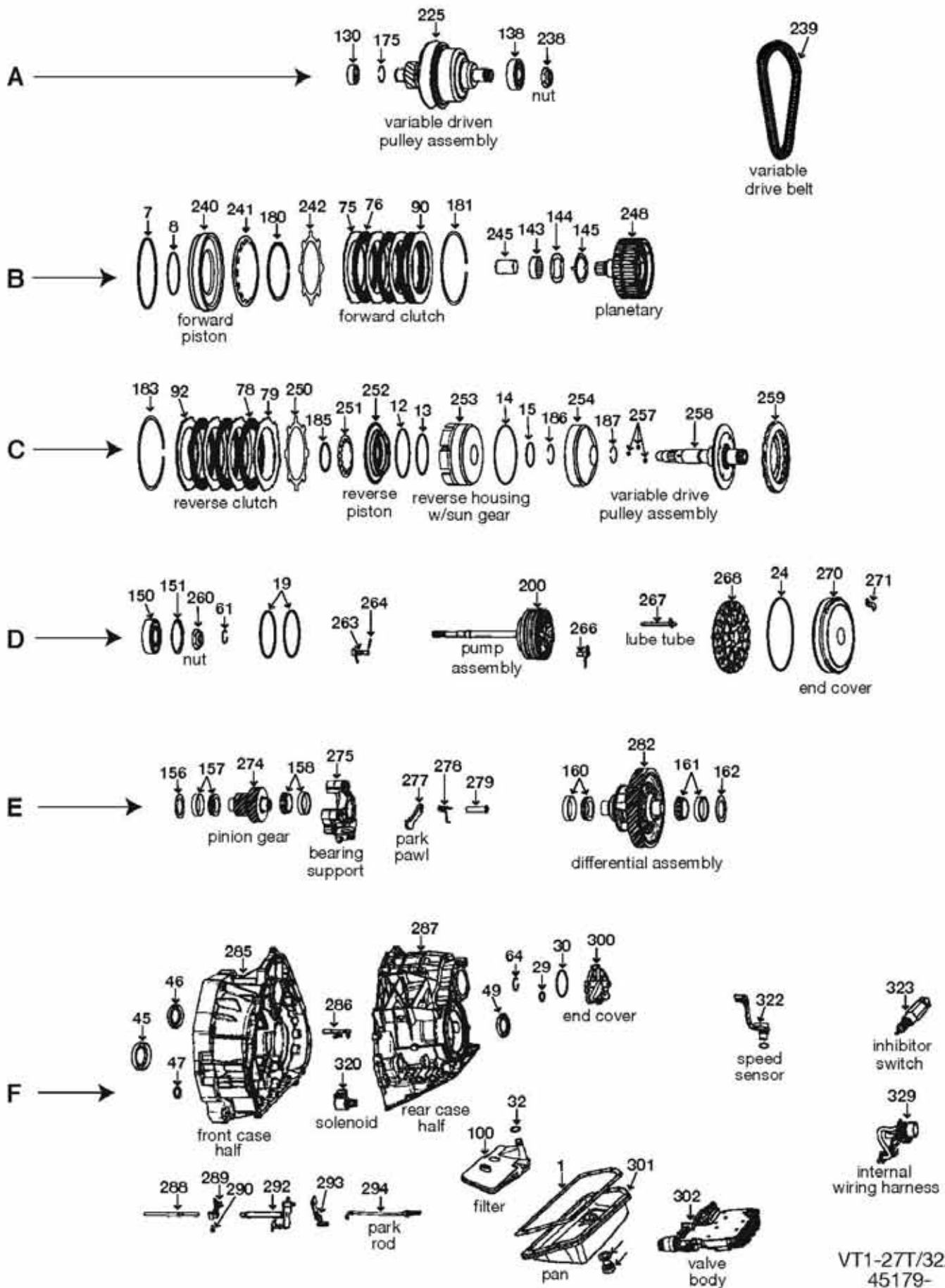

VT1-27T/32A
45179-

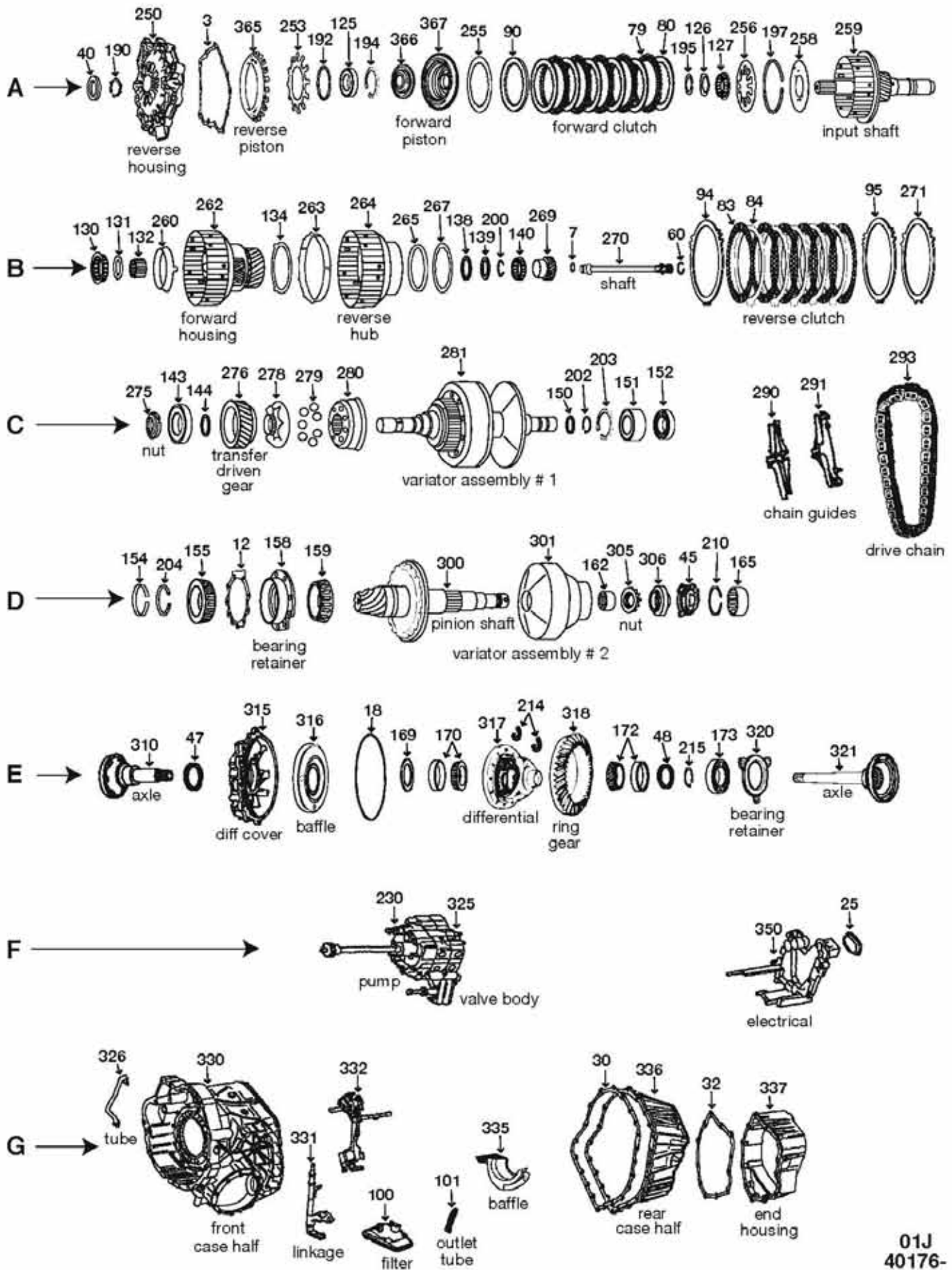

01J
40176-

ILL	DESCRIPTION	QTY	YEAR	REFERENCE #	PART #
TECHNICAL MANUALS					
K53	Technicians diagnostic guide 01J-CVT general information case id and more	1	02-11	01J Tech-guide	010-484
REBUILDER KITS					
K5	Master kit with steels w/pistons	1	02-11	151901	40176-11004
K5	Master kit with steels w/o pistons	1	02-11	181905X	40176-11104
K6	Master kit w/o steels w/pistons	1	02-11	151901LS	40176-12004
K6	Master kit w/o steels w/o pistons	1	02-11	151901XLS	40176-12104
K7	O/H gasket set w/seals-rings w/pistons	1	02-11	151804	40176-13004
K7	O/H gasket set w/seals-rings w/o pistons	1	02-11	FDB-2514	40176-13104
GASKETS AND RUBBER COMPONENTS					
A3	Gasket, reverse housing 01J	1	02-11	n/a	40176-28204
E18	O'ring, differential cover 01J	1	02-11	n/a	40176-21804
F25	Gasket, case connector molded rubber	1	02-11	n/a	40176-22604
G30	Gasket, rear case 01J	1	02-11	n/a	40176-28504
G32	Gasket, end housing 01J	1	02-11	n/a	40176-28804
METAL CLAD SEALS					
A40	Seal, metal clad front	1	02-11	n/a	40176-30104
E47	Seal, metal clad left axle	1	02-11	n/a	40176-30304
E48	Seal, metal clad right axle	1	02-11	n/a	40176-30504
CLUTCH PLATES					
A79	Friction .080" 4.332" id 30T (external T) forward clutch	7	02-11	01J-323-944S	40176-35204
A79	Friction .107" 4.332" id 30T (external T) forward clutch	6	02-11	151700-270	40176-35403
A80	Steel .076" 5.434" id 26T (internal teeth) forward clutch	4	02-11	151701-195	40176-37604
A80	Steel .089" 5.434" id 26T (internal teeth) forward clutch	1	02-11	151701-225	40176-37804
A80	Steel .098" 5.434" id 26T (internal teeth) forward clutch	2	02-11	151701-250	40176-38004
B83	Friction .107" 7.160" id 40T (internal T) low/reverse clutch	6	02-11	151702-270	40176-35604
B84	Steel .076" 6.398" id 3T (external teeth) low/reverse clutch	3	02-11	151703-195	40176-38204
B84	Steel .076" 6.398" id 3T (external teeth) low/reverse clutch (3 tabs)	3	02-11	1517036A-175	40176-38403
B84	Steel .089" 6.398" id 3T (external teeth) low/reverse clutch	1	02-11	151703-225	40176-38604
B84	Steel .098" 6.398" id 3T (external teeth) low/reverse clutch	3	02-11	151703-250	40176-38804
PRESSURE PLATES					
A90	Pressure plate forward clutch	1	02-11	AE	40176-41203
B94	Pressure plate low/reverse clutch	1	02-11	AE	40176-41403
B95	Pressure plate low/reverse clutch	1	02-11	AE	40176-41603
FILTERS					
G100	Filter 01J	1	02-11	01J-301-519N	40176-45104
G101	Tube, filter outlet 01J	1	02-11	01J-301-539A	40176-45204
WASHERS/BEARINGS/RACES/SHIMS					
A125	Bearing, ball reverse housing	1	02-11	n/a	40176-56304
A126	Race, thrust input shaft to reverse housing	1	02-11	n/a	40176-56604
A127	Bearing, caged input shaft to reverse housing	1	02-11	n/a	40176-56704
B130	Bearing, caged forward housing to input shaft	1	02-11	n/a	40176-57104
B131	Race, thrust forward housing to input shaft	1	02-11	n/a	40176-57204
B132	Bearing, caged forward housing to input shaft	1	02-11	n/a	40176-57304
B134	Washer, thrust forward housing to reverse hub	1	02-11	n/a	40176-57604
B138	Bearing, thrust sun gear	1	02-11	n/a	40176-57804
B139	Race, thrust sun gear	1	02-11	n/a	40176-57904
B140	Bearing, caged sun gear	1	02-11	n/a	40176-58104
C143	Bearing, ball variator #1 support	1	02-11	n/a	40176-58304
C144	Washer, shim variator #1 support	sel	02-11	n/a	40176-58504
C150	Washer, shim variator #1 support	sel	02-11	n/a	40176-58704
C151	Bearing, ball variator #1 support	1	02-11	n/a	40176-58904
C152	Bearing, ball variator #1 support	1	02-11	n/a	40176-59104
D155	Bearing, cup/cone pinion shaft	1	02-11	n/a	40176-59204

01J (Multitronic)•VL300-381

01J (Multitronic)

ILL	DESCRIPTION	QTY	YEAR	REFERENCE #	PART #	
WASHERS/BEARINGS/RACES/SHIMS (CONTINUED)						
D158	Retainer, pinion shaft bearings	01J	1	02-11	AE	40176-59303
D159	Bearing, cup/cone	pinion shaft	1	02-11	n/a	40176-59404
D162	Bearing, caged	axle shaft	1	02-11	n/a	40176-59504
D165	Bearing, caged	pinion shaft	1	02-11	n/a	40176-59604
E169	Washer, shim	differential carrier	sel	02-11	n/a	40176-59704
E170	Bearing, cup/cone	differential (right side)	1	02-11	n/a	40176-59804
E172	Bearing, cup/cone	differential (left side)	1	02-11	n/a	40176-59804
E173	Bearing, ball	right axle support	1	02-11	n/a	40176-60504
SNAP RINGS						
A190	Snap ring	reverse housing	1	02-11	AE	40176-62103
A192	Snap ring	reverse retainer	1	02-11	AE	40176-62203
A194	Snap ring	bearing in reverse housing	1	02-11	AE	40176-62303
A195	Snap ring	forward retainer	1	02-11	AE	40176-62503
A197	Snap ring	forward clutch retainer	1	02-11	AE	40176-62603
B200	Snap ring	sun gear	1	02-11	AE	40176-62703
C202	Snap ring	bearing on variator #1	1	02-11	AE	40176-62803
C203	Snap ring	bearing retainer	1	02-11	AE	40176-63003
D204	Snap ring	bearing retainer	1	02-11	AE	40176-63203
D210	Snap ring	caged bearing	1	02-11	AE	40176-63503
E215	Snap ring	bearing retainer	1	02-11	AE	40176-63803
PUMP PARTS AND PUMPS						
F230	Pump assembly	01J	1	02-11	AE	40176-67003
HARD PARTS						
A250	Housing, reverse	01J	1	02-11	AE	40176-72303
A253	Spring, return	01J	1	02-11	AE	40176-72503
A255	Plate, waved	forward clutch	1	02-11	AE	40176-72803
A256	Spring, diaphragm	forward clutch	1	02-11	AE	40176-73403
A258	Retainer, spacer	forward clutch	1	02-11	AE	40176-73503
A259	Shaft, input w/sun gear	01J	1	02-11	AE	40176-73703
B260	Spacer, forward housing	01J	1	02-11	AE	40176-74003
B262	Housing, forward clutch	planetary w/transfer drive gear	1	02-11	AE	40176-74303
B263	Spacer, reverse housing	01J	1	02-11	AE	40176-74503
B264	Hub, reverse clutch	01J	1	02-11	AE	40176-74703
B265	Spacer, reverse hub	01J	1	02-11	AE	40176-74903
B267	Spacer, reverse hub	01J	1	02-11	AE	40176-75003
B269	Gear, sun	01J	1	02-11	AE	40176-75303
B271	Plate, waved (reverse clutch)	01J	1	02-11	AE	40176-75503
C275	Nut, transfer drive gear	01J	1	02-11	AE	40176-75703
C276	Gear, transfer driven	01J	1	02-11	AE	40176-76003
C278	Cam, outer retainer	01J	1	02-11	AE	40176-76103
C279	Rollers	01J	7	02-11	AE	40176-76203
C280	Cam, inner retainer	01J	1	02-11	AE	40176-76303
C281	Pulley, variator #1	01J	1	02-11	AE	40176-76503
C290	Guide, chain	01J	1	02-11	AE	40176-76803
C291	Guide, chain	01J	1	02-11	AE	40176-76903
C293	Chain, drive	01J	1	02-11	n/a	40176-77004
C293	Chain, drive	01J	1	02-11	AE	40176-77003
D300	Gear, ring/pinion	01J	1	02-11	AE	40176-77503
D301	Pulley, variator #2	01J	1	02-11	AE	40176-77803
D305	Nut, pulley variator #2	01J	1	02-11	AE	40176-78003
D206	Retainer, pulley variator #2	01J	1	02-11	AE	40176-78103
E310	Shaft, left axle	01J	1	02-11	AE	40176-78503
E315	Housing, differential cover	01J	1	02-11	AE	40176-78803

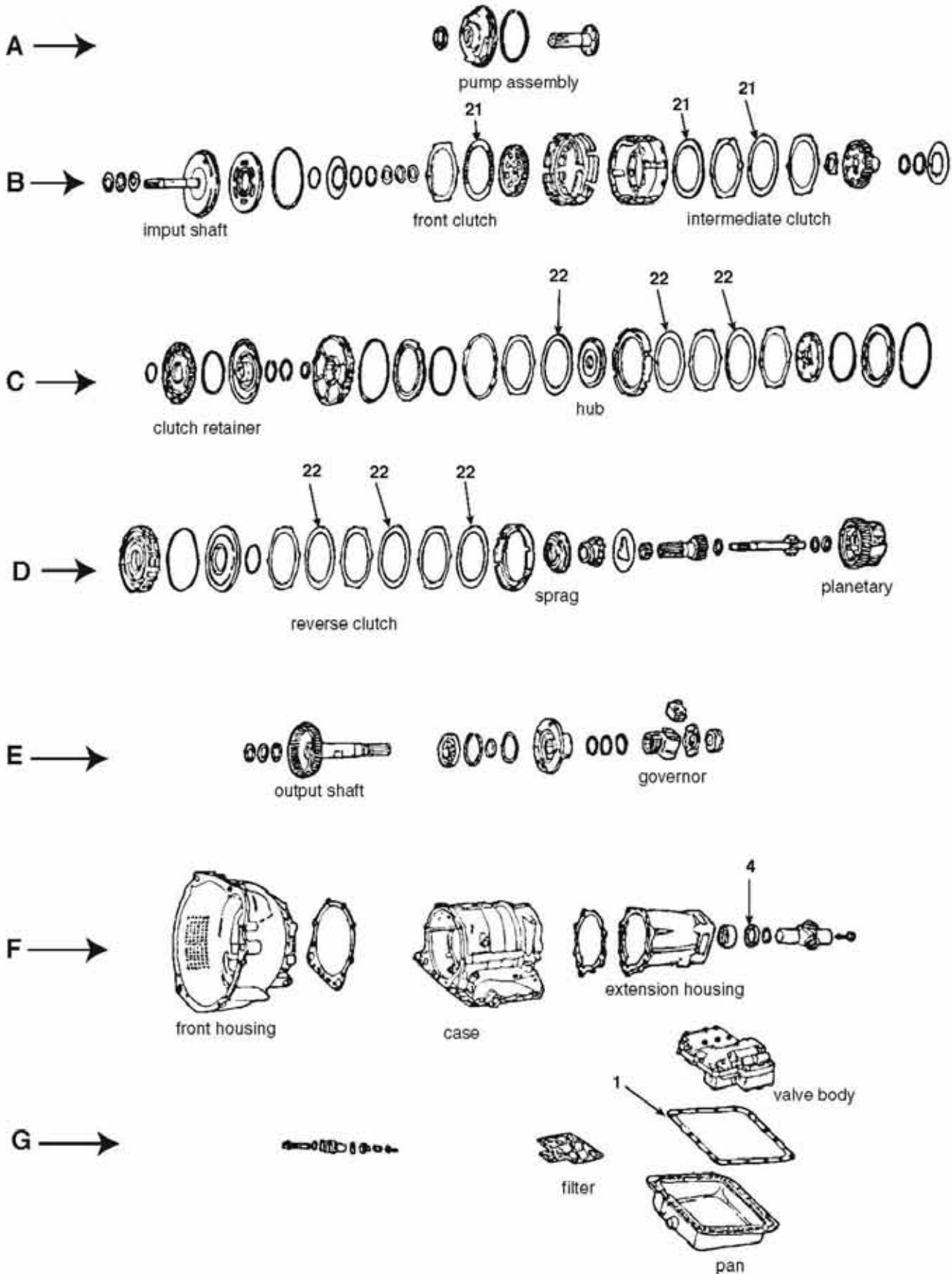

ZF3HP12/ZF3HP20
56000

ILL	DESCRIPTION		QTY	YEAR	REFERENCE #	PART #
REBUILDER KITS						
K5	Master kit w/steels	ZF3HP12/20	1	60-83	AE	K5600
K6	Master kit w/o steels	ZF3HP12/20	1	60-83	AE	K5600-LS
K7	O/H gasket set w/seals-rings	ZF3HP12/20	1	60-83	AE	K56900
GASKETS AND RUBBER COMPONENTS						
G1	Gasket, oil pan - w/uniform perimeter	ZF12	1	60-83		13890X
METAL CLAD SEALS						
F4	Seal, metal clad	ZF3HP12/20	1	60-83	046-504-4002H	47201
F4	Seal, metal clad	Peugeot (extension housing)	1	60-83	n/a	56201C
CLUTCH PLATES						
B21	Friction forward (A) clutch-1st pack	.070" 5.45"od 56T grooved	7	60-83	24231-201-062	56107
CD22	Friction rear clutch	.076" 5.45"od 56T smooth	8	60-83	24231-205-106	56108
BUSHINGS						
n/i	Bushing .750" (bronze)	2500cc large	1	60-83	n/a	56005A
HARD PARTS						
n/i	Valve body	ZF3HP12/20	1	71-83	AE	56385-R
NOTES						

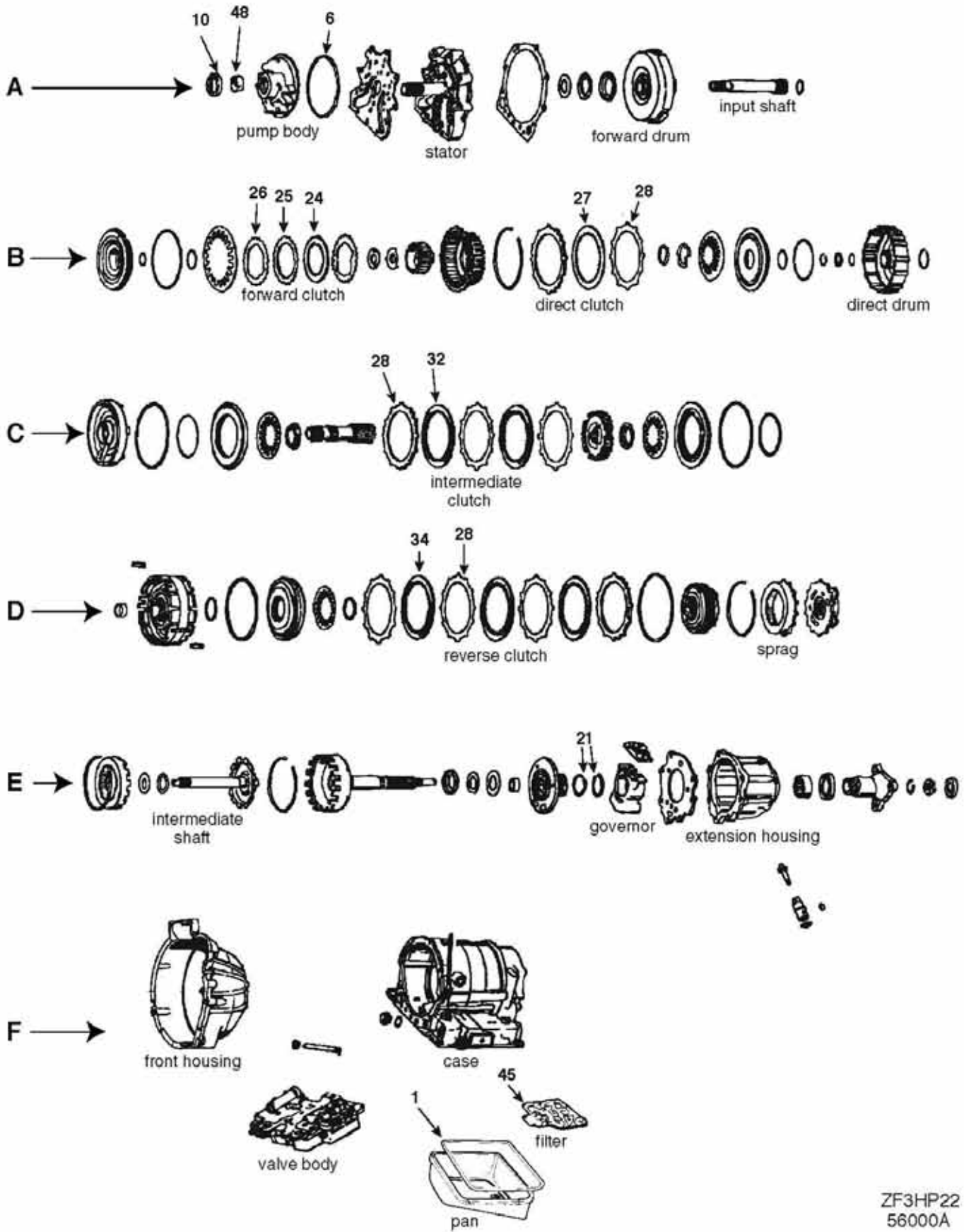

ZF3HP22
56000A

ILL	DESCRIPTION	QTY	YEAR	REFERENCE #	PART #	
REBUILDER KITS						
K4	Master deluxe rebuild kit	ZF3HP22	1	76-84	AE	K5600A-R
K5	Master kit w/steels	ZF3HP22	1	76-84	AE	K5600A
K6	Master kit w/o steels	ZF3HP22	1	76-84	AE	K5600A-LS
K7	O/H gasket set w/seals-rings	ZF3HP22	1	76-84	AE	K56900A
GASKETS AND RUBBER COMPONENTS						
F1	Gasket, oil pan (molded rubber)	ZF3HP22	1	76-84	24-11-1-205-903	13620R
A6	O'ring	pump body	1	76-84	24-31-1-206-029	23058
n/i	Gasket, filter spacer to valve body	ZF3HP22	1	76-84	24-34-1-205-974	13640
METAL CLAD SEALS						
A10	Seal, metal clad 40x52x7mm	front	1	74-84	24-31-1-207-621	56200D
n/i	Seal, metal clad	extension housing	1	76-84	24-11-1-218-009	56201B
n/i	Seal, metal clad	shift shaft	1	76-84	24.34-1-207-430	56202
SEALING RINGS						
K10	Kit, sealing ring-complete	ZF3HP22	1	76-84	AE	K56300A
n/i	Sealing ring	input shaft	1	76-84	24-31-1-207-621	56307
n/i	Sealing ring	sun gear shaft	2	76-84	24.21-1-216-358	56304
E21	Sealing ring	governor support	2	76-84	24-32-1-205-972	56300
n/i	Sealing ring	direct clutch	1	76-84	24-23-1-215-840	56301
CLUTCH PLATES						
B24	Friction .061" 3.931" od 34T	forward clutch	4/5	76-84	1058-270-020	56103A
B25	Steel .071" 3.000" id 24T	forward clutch	5/6	76-84	1043-302-046	56100
B25	Steel .082" 3.000" id 24T	forward clutch	sel	76-84	1043-302-127	56100A
B25	Steel .060" 3.000" id 24T	forward clutch	sel	76-84	APC-53711	56100B
B25	Steel .047" 3.000" id 24T	forward clutch	sel	76-84	1043-302-123	56100C
B26	Steel .040" 3.000" id 24T (waved)	forward clutch	2	76-84	1043-302-001	56105
B27	Friction .061" 5.629" od 58T	direct clutch	4	76-84	1043-202-041	56102B
B28	Steel .071" 4.728" id 12T	direct clutch	4	76-84	0301-302-037	56101
C32	Friction .059" 5.629" od 24T	intermediate clutch	4	76-84	1043-202-041	56102A
C28	Steel .071" 4.728" id 12T	intermediate clutch	3/4	76-84	0301-302-037	56101
D34	Friction .063" 5.625" od 48T	reverse clutch	4/5	76-84	1056-210-053	56106A
D28	Steel .071" 4.690" id 12T	reverse clutch	3/4	76-84	0301-302-037	56101K
n/i	Steel .047" 4.690" id 12T	direct/intermediate/reverse clutch	sel	76-84	0301-317-013	56101C
n/i	Steel .047" 4.690" id 12T (waved)	direct/intermediate/reverse clutch	sel	76-84	1043-302-036	56101D
n/i	Steel .060" 4.690" id 12T	direct/intermediate/reverse clutch	sel	76-84	1043-302-020	56101E
n/i	Steel .082" 4.690" id 12T	direct/intermediate/reverse clutch	sel	76-84	1043-302-021	56101F
FILTERS						
K9	Kit, filter	ZF3HP22	1	76-84	AE	FK56800A
F45	Filter	ZF3HP22	1	76-84	1024-223-3002	56800A
BUSHINGS						
A48	Bushing .500"	pump body	1	76-84	0501-3114-526	56005
n/i	Bushing	1st housing/center support/governor	3	76-84	n/a	56003
PUMP PARTS AND PUMPS						
A	Shaft, stator (push-out)	ZF3HP22	1	76-84	n/a	56969
A	Body, pump w/gears	ZF3HP22	1	76-84	AE	56300-R
A	Support, pump w/shaft	ZF3HP22	1	76-84	AE	56400-R
HARD PARTS						
n/i	Valve body	ZF3HP22	1	76-84	AE	56285-R
SPRAGS						
n/i	Sprag, low	staked in low planetary	1	76-84	24-23-1-215-338	56503
NOTES						

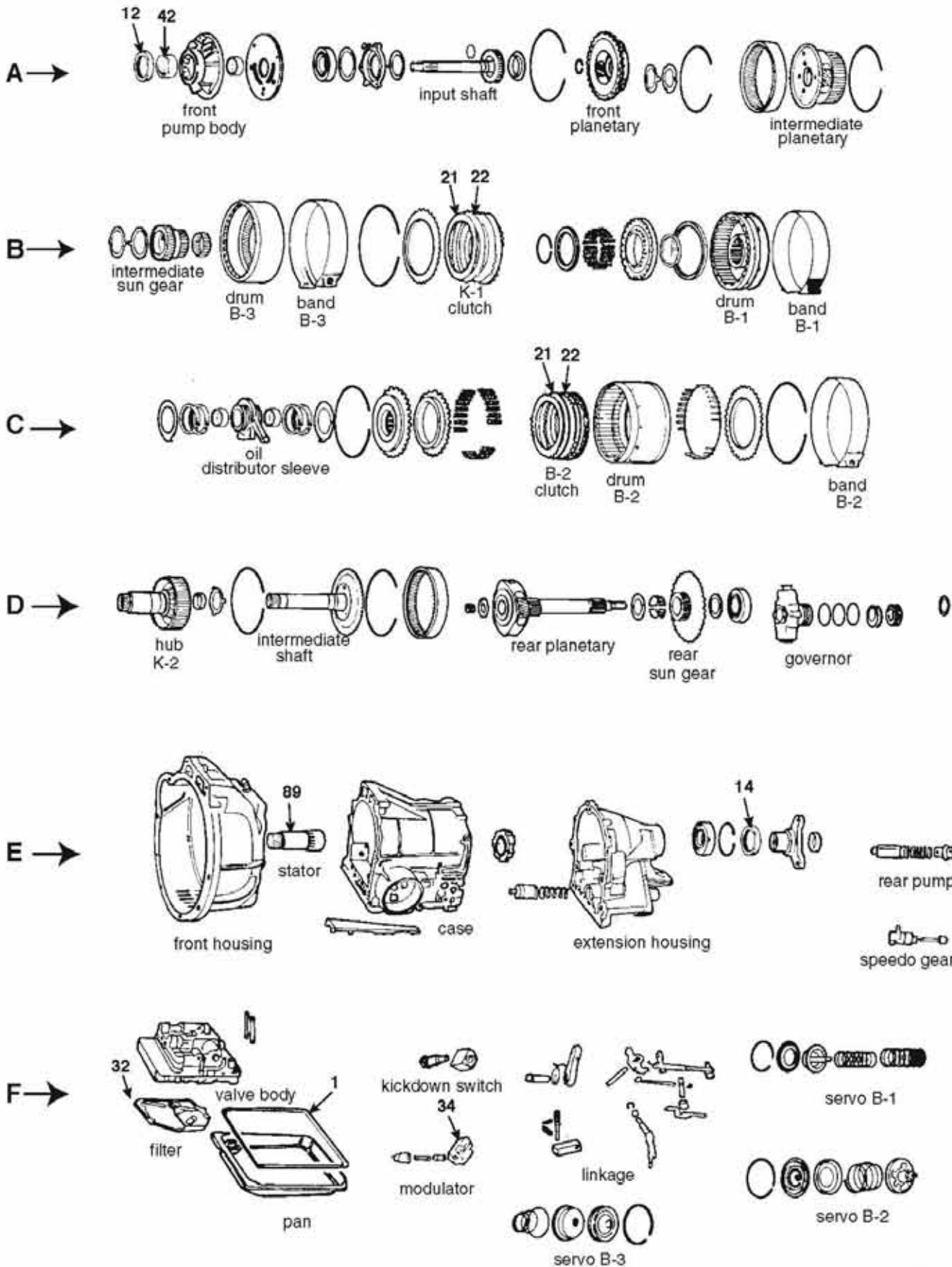

772.0/772.2
55000

ILL	DESCRIPTION		QTY	YEAR	REFERENCE #	PART #
TECHNICAL MANUALS						
K53	Tech manual-covers 722.0/1 dis/assembly	diagnosis & troubleshooting	1	70-81	83-7222TM	010-421
REBUILDER KITS						
K5	Master kit w/steels	722.0/722.1 (4-bolt pan)	1	70-81	AE	K5500
K6	Master kit w/o steels	722.0/722.1 (4-bolt pan)	1	70-81	AE	K5500-LS
K7	O/H gasket set w/seals-rings	722.0/722.1 (4-bolt pan)	1	70-81	AE	K55900
GASKETS AND RUBBER COMPONENTS						
F1	Gasket, pan (cork and rubber)	16-bolt pan	1	62-69	n/a	13840X
F1	Gasket, pan (square molded rubber)	4-bolt pan	1	70-81	115-271-1680	13840R
METAL CLAD SEALS						
A12	Seal, metal clad front pump	6 cylinder	1	70-81	008-997-2546	55200
A12	Seal, metal clad front pump	8 cylinder	1	70-81	004-997-0547	55201
E14	Seal, metal clad	722.0/722.1/722.1	1	70-81	005-997-1146	22978
n/i	Seal, metal clad side servo	front B-2	1	70-81	115-272-1192	55203
n/i	Seal, metal clad manual lever	722.0/722.1/722.1	1	70-81	006-997-6146	55204
n/i	Seal, metal clad speedo housing	722.0/722.1/722.1	1	70-81	011-997-6447	55205
CLUTCH PLATES						
B21	Friction .083" 5.318" od 51T (waved)	K-1 clutch	4	70-81	112-272-0235	55100
B22	Steel .079" 4.073" id 12T	K-1 clutch	sel	70-81	119-272-1526	55101
B22	Steel .118" 4.073" id 12T	K-1 clutch	sel	70-81	109-272-0626	55101A
B22	Steel .138" 4.073" id 12T	K-1 clutch	sel	70-81	109-272-1426	55101B
C21	Friction .083" 5.318" od 51T (waved)	B-2 clutch	4	70-81	112-272-0235	55100
C22	Steel .079" 4.073" id 12T	B-2 clutch	sel	70-81	119-272-1526	55101
C22	Steel .118" 4.073" id 12T	B-2 clutch	sel	70-81	109-272-0626	55101A
C22	Steel .138" 4.073" id 12T	B-2 clutch	sel	70-81	109-272-1426	55101B
n/i	Friction .098" 5.318" od 51T (waved)	K-1/B-2 clutch	ar	70-81	112-272-0225	55100A
FILTERS						
K9	Kit, Filter Mercedes-rectangular	w/o pipe	1	72-81	AE	FK55800A
K9	Kit, Filter Mercedes-rectangular	w/1" pipe	1	77-81	AE	FK55800B
K9	Kit, Filter Mercedes-rectangular	w/ 3/4" pipe	1	70-77	AE	FK55800C
F32	Filter, oil-rectangular	w/o pipe	1	72-81	115-270-0398	55800A
F32	Filter, oil-rectangular	w/1" pipe	1	77-81	109-270-0298	55800B
F32	Filter, oil-rectangular	w/ 3/4" pipe	1	70-77	123-270-0098	55800C
MODULATORS						
F34	Modulator, screw in	w/green dot-metal	1	70-81	000-270-0179	55820
F34	Modulator, screw in	w/white plastic top	1	70-81	123-270-0079	55820A
F34	Modulator, screw in	w/red plastic top	1	70-81	123-270-0679	55820B
BUSHINGS						
A42	Bushing, front pump body	1.85" od	1	70-81	112-272-4350	55005
A42	Bushing, front pump body	1.27" od	1	70-81	n/a	55005A
PUMP PARTS AND PUMPS						
E89	Support, stator	shaft only-clip in	1	70-80		55970
E89	Support, stator	shaft only-press in 4" long	1	70-81		55969
NOTES						

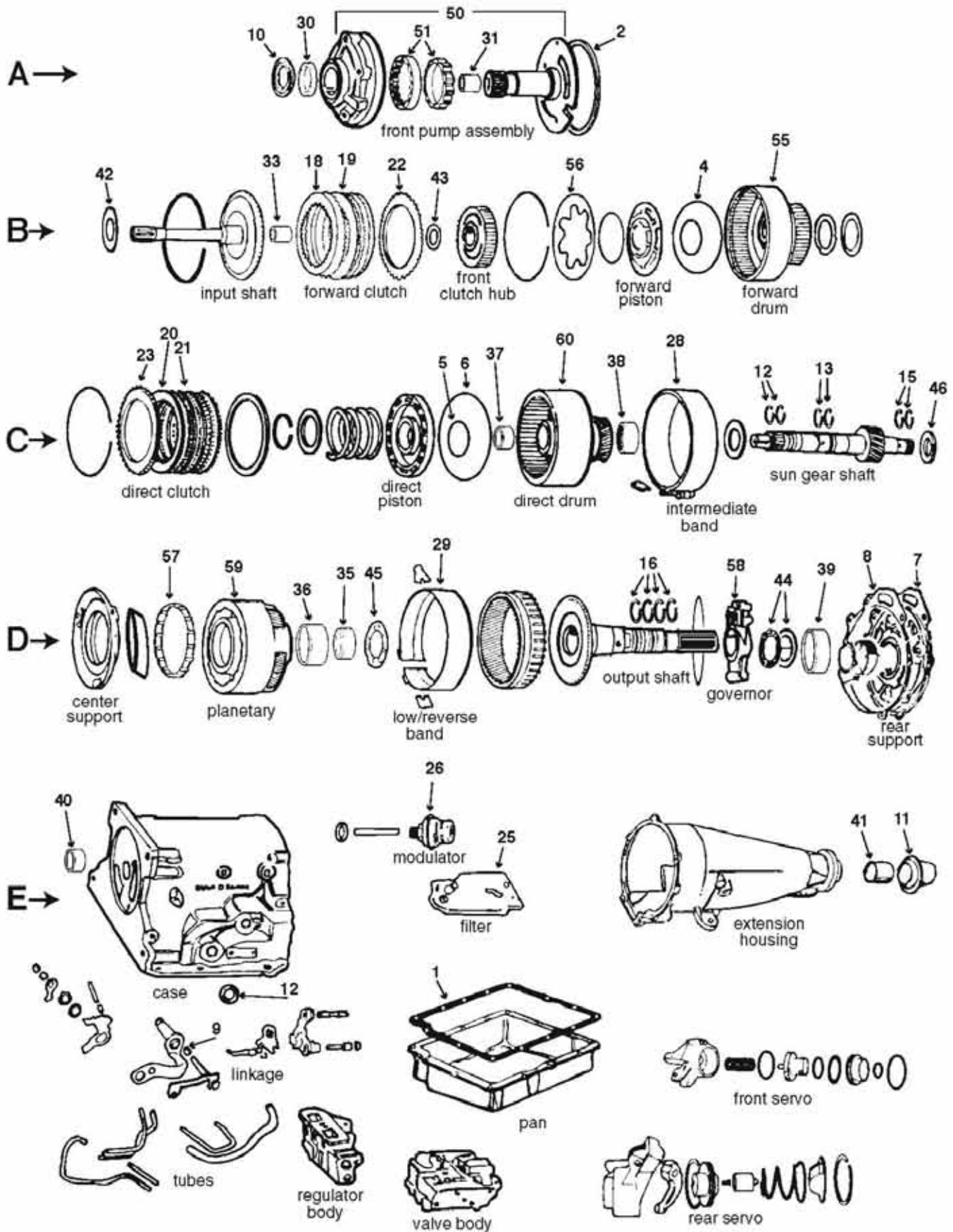

FMX/CW/BW8/BW12/R12
600M/N/V/W

ILL	DESCRIPTION	QTY	YEAR	REFERENCE #	PART #
REBUILDER KITS					
K4	Master deluxe rebuild kit	1	68-81	AE	K600M-R
K5	Master kit w/steels	1	55-67	AE	K600W
K5	Master kit w/steels	1	51-67	AE	K600V
K5	Master kit w/steels	1	67-72	AE	K600R
K5	Master kit w/steels	1	67-74	AE	K600N
K5	Master kit w/steels	1	68-81	AE	K600M
K6	Master kit w/o steels	1	55-67	AE	K600W-LS
K6	Master kit w/o steels	1	51-67	AE	K600V-LS
K6	Master kit w/o steels	1	67-72	AE	K600R-LS
K6	Master kit w/o steels	1	67-74	AE	K600N-LS
K6	Master kit w/o steels	1	68-81	AE	K600M-LS
K7	O/H gasket set w/seals-rings	1	55-67	AE	K6900W
K7	O/H gasket set w/seals-rings	1	51-67	AE	K6900V
K7	O/H gasket set w/seals-rings	1	67-74	AE	K6900N
K7	O/H gasket set w/seals-rings	1	68-81	AE	K6900M
K8	Kit, external seal	1	68-81	AE	K6900M-2
K11	Gasket and seal kit	1	51-67	AE	K6900V-1
K11	Gasket and seal kit	1	55-67	AE	K6900U-1
K11	Gasket and seal kit	1	67-74	AE	K6900N-1
K11	Gasket and seal kit	1	68-81	AE	K6900M-1
VALVE BODY KITS					
K15	Shift Kit®	1	67-72	SK® 3-67	K6253C
K15	Shift Kit®	1	73-81	SK® 3-73	K6253D
K15	Reprogramming Kit™	1	68-72	37-2	37-1
K15	Reprogramming Kit™	1	73-81	33-2	33-1
GASKETS AND RUBBER COMPONENTS					
E1	Gasket, oil pan	1	51-81	B5AZ-7A191-B	3565LX
E1	Gasket, oil pan	1	51-81	B5AZ-7A191-B	3565D
E1	Gasket, oil pan	1	55-72	B5SZ-7A191-B	3610LX
E1	Gasket, oil pan	1	55-72	B5SZ-7A191-B	3610D
E1	Gasket, oil pan	1	61-65	C1VP-7A191-B	3741LX
A2	Seal, lathe cut	1	51-81	B1AZ-7A136-A	3666
B4	Seal, lathe cut	1	68-81	D1AZ-7A548-A	13312
C5	Lip seal	1	68-81	C8AZ-7E212-A	13286
C6	Lip seal	1	68-81	C8AZ-7C051-A	13285
D7	Gasket	1	56-66	3150992	13297
D7	Gasket	1	67-71	3186571	13298
D7	Gasket	1	68-81	D2AZ-7086-A	13283A
D8	Gasket	1	68-81	C8AZ-7A222-A	13284
E9	O'ring	1	68-81	386078-S	3499L
n/i	O'ring	1	68-81	87036-S94	3410L
METAL CLAD SEALS					
A10	Seal, metal clad (w/o flange)	1	68-81	C2AZ-7A248-A	16601B
A10	Seal, metal clad	1	51-74	3151007	6550C
E11	Seal, metal clad 60x38x10mm (w/boot)	1	51-67	D5AZ-7052-B	16695E
E11	Seal, metal clad 60x38x12mm	1	51-68	D5AZ-7052-BNF	8850B
E11	Seal, metal clad (w/flange w/o boot)	1	55-68	D5AZ-7052-ANB	4743C
E11	Seal, metal clad (w/boot)	1	56-81	D5AZ-7052-A	16695C
E11	Seal, metal clad	1	61-65	C6VY-7052-A	6557G
E11	Seal, metal clad	1	65-67	B3TZ-7A011-A	6557M
E12	Seal, metal clad	1	51-81	C7AZ-7B498-A	6507A

ILL	DESCRIPTION	QTY	YEAR	REFERENCE #	PART #
SEALING RINGS					
K10	Kit, sealing ring (metal) FMX	1	68-81	AE	K6909C
K10	Kit, sealing ring (metal) small case	1	51-71	AE	K6909
K10	Kit, sealing ring (metal) MX/medium case	1	55-68	AE	K6909A
K10	Kit, sealing ring (metal) large case	1	58-65	AE	K6909B
K10	Kit, sealing ring (metal) R12/CW	1	67-71	AE	K6909C
C12	Ring, sealing FMX/small (forward clutch to sun gear/frt)	2	51-81	IP-77542-A	6230
C12	Ring, sealing medium (forward clutch to sun gear/front)	2	55-71	B5SZ-77542-A	6230A
C13	Ring, sealing FMX/small (direct clutch to sun gear/mid)	2	51-81	C0AZ-7C169-A	6231
C13	Ring, sealing medium (direct clutch to sun gear/middle)	2	55-71	B5SZ-7C169-A	7516
C15	Ring, sealing FMX/BW 8-12/SX/CW/R12 (rear/sun gear)	2	51-81	IP-77543-B	6235
D16	Ring, sealing (metal) FMX (output shaft)	4	68-81	C6AZ-7D019-B	36401
D16	Ring, sealing (metal) small/medium (output shaft)	4	51-67	IP-77883-A	6245
CLUTCH PLATES					
B18	Friction .060" 5.250" od 45T (grooved) forward clutch (front housing)	4/5	51-81	C9AZ-7B164-A	6204G
B18	Friction .062" 5.250" od 45T forward clutch (front housing)	4/5	56-71	B5AZ-7B164-B	6204M
B18	Friction .078" 5.250" od 45T (waffle) forward clutch (front housing)	ar	67-81	C9AZ-7B164-D	6204P
B19	Steel .068" 3.903" id 54T (flat) forward clutch (front housing)	3/4	51-81	C8AZ-7B442-A	6205
B19	Steel .090" 3.903" id 54T (oversized) front/rear clutch	ar	68-81	C2AZ-7B442-A	6222B
C20	Friction .062" 5.250" od 45T direct clutch (rear drum)	4/5	56-71	B5AZ-7B164-B	6204M
C20	Friction .095" 5.250" od 45T direct clutch (rear drum)	5	56-66	C2AZ-7B164-A	6221G
C20	Friction .079" 5.250" od 45T direct clutch (rear drum)	ar	68-81	C8AZ-7B164-G	6221B
C21	Steel .065" 3.903" id 50T (dished) direct clutch (rear drum)	5	51-67	B1AZ-7B442-A	6222
C21	Steel .068" 3.903" id 54T (flat) direct clutch (rear drum)	4/5	68-81	C8AZ-7B442-A	6205
PRESSURE PLATES					
B22	Pressure plate .254" (beveled) FMX/MX front/forward clutch	1	68-81	C1AP-7B066-A	6307-R
C23	Pressure plate .313" rear/direct clutch	1	68-81	B8SZ-7B437-A	6309-R
FILTERS					
K9	Kit, filter (felt) FMX (neoprene/cork)	1	68-81	AE	FK6582F
K9	Kit, filter (felt) FMX (Duraprene®)	1	68-81	AE	DK6582F
K9	Kit, filter (brass) FMX (neoprene/cork)	1	68-81	AE	FK6582D
K9	Kit, filter (brass) FMX (neoprene/cork)	1	68-81	AE	DK6582D
K9	Kit, filter (brass) MX/medium case (neoprene/cork)	1	55-67	AE	FK6582G
K9	Kit, filter (brass) MX/medium case (Duraprene®)	1	55-67	AE	DK6582G
K9	Kit, filter (brass) SX/small case (neoprene/cork)	1	51-67	AE	FK6582C
K9	Kit, filter (brass) SX/small case (Duraprene®)	1	51-67	AE	DK6582C
K9	Kit, filter (small flat brass) R12/CW (neoprene/cork)	1	67-71	AE	FK6582H
K9	Kit, filter (small flat brass) R12/CW (Duraprene®)	1	67-71	AE	DK6582H
E25	Filter, screen (felt) FMX (1 suction hole)	1	68-81	D8AZ-7A098-A	6582F
E25	Filter, screen (brass) FMX (1 suction hole)	1	68-81	D0AZ-7A098-A	6582D
E25	Filter, screen (brass) MX/medium case (2 suction holes)	1	55-67	B9MP-7A098-B	6582G
E25	Filter, screen (brass) SX/small case (2 suction holes)	1	51-67	B9AP-7A098-B	6582C
E25	Filter, screen (flat brass) AMX/BW8/BW12/CW	1	67-71	3186706	6582H
n/i	Screen, filter FMX (governor)	1	68-81	D1AZ-7E242-A	53712
MODULATORS					
E26	Modulator, vacuum-screw in-SAD adjustable (blue)	1	68-81	C1AZ-7A377-B	16525D
E26	Modulator, vacuum-screw in-DAD adjustable (orange)	1	73-81	D322-7A377-A	16525F
E26	Modulator, vacuum-screw in-SAD adjustable (light green)	1	75-81	D5AZ-7A377-C	16525G
BANDS					
C28	Band, flex type FMX (front/center lug)	1	73-82	D7AZ-7A162-A	6313X
C28	Band, rigid (thin paper lining) front (center lug)	1	68-73	D2AZ-7A162-A	6313R-RL
C28	Band, rigid 1 15/16" (thin paper lining) front (offset lug)(small case)	1	67-71	C7AZ-7A162-A	6313N-RL
C28	Band, rigid (thick lining) front (center lug)(medium case)	1	55-66	C2AZ-7A162-A	6313C-RL
C28	Band, rigid 1 15/16" (thick lining) front (offset lug)(small case)	1	55-66	C2AZ-7A162-B	6313E-RL

ILL	DESCRIPTION		QTY	YEAR	REFERENCE #	PART #
BANDS (CONTINUED)						
C28	Band, rigid 1 5/8" wide	front (offset lug)(small case)	1	51-55	B6AZ-7A162-A	6313D-RL
D29	Band, rigid	rear (all)	1	55-81	B5SZ-7A163-B	6362A-RL
BUSHINGS						
K13	Kit, bushing	FMX	1	68-81	AE	K6901
A30	Bushing (babbit)	FMX (front pump)	1	68-81	C6AZ-7B258-A	36002A
A30	Bushing (bronze)	FMX (front pump)	1	68-81	C6AZ-7B258-A	36002
A30	Bushing	small/medium/large case (front pump)	1	51-71	C1AZ-7B258-A	6010
A31	Bushing (not in kit)	FMX (stator support/pump cover)	1	68-81	C8AZ-7B261-A	6017D
B33	Bushing	FMX/small case (input shaft)	1	68-81	B1AZ-7120-A	6008
D35	Bushing 1" id x 7/8"	FMX/small case (planetary inner)	1	68-81	B1AZ-7B257-B	6004
D36	Bushing 1 1/2" x 3/4" (not in kit)	FMX/small case (planetary outer)	1	68-81	B5AZ-7B256-A	6019
C38	Bushing	FMX/small case (direct clutch/rear drum)	1	68-81	B1AZ-7B262-2	6003
D39	Bushing (babbit w/oil groove wide)	FMX/small case (rear pump body)	1	68-81	B5AZ-7B260-A	6015
E40	Bushing	FMX/small case (case)	1	68-81	B5A-7025-A	6007
E41	Bushing (babbit)	small case (extension housing)	1	51-67	B3TZ-7A034-A	6014
E41	Bushing (not in kit)	large case (extension housing)	1	61-65	C1VY-7A034-A	6023B
E41	Bushing	BW12 (extension housing)	1	67-81	3207936	12501A
E41	Bushing, extension housing	FMX/medium case (extension housing)	1	68-81	B5AZ-7A034-A	6023
WASHERS/BEARINGS/RACES/SHIMS						
C37	Bearing, caged (not in kit)	direct clutch/rear drum (FMX/small case)	1	68-81	C8AZ-7D480-A	6002
B42	Thrust washer 1 3/8" id x 2 25/32" od	input shaft	1	68-81	D3AZ-7019-A	6201B
B43	Thrust washer (fiber)	front clutch hub	1	68-81	B5S-775-77-B	6203A
D44	Race	output shaft (rear)	1	68-81	n/a	6238
D44	Bearing, thrust (1-3 piece)	output shaft	1	78-81	D8AZ-7B368-A	6239X
D45	Thrust washer .062"	output shaft	sel	68-81	C5AZ-7A385-E	6237H
D45	Thrust washer .068"	output shaft	sel	68-81	C5AZ-7A385-F	6237I
D45	Thrust washer .075"	output shaft	sel	68-81	C5AZ-7A385-G	6237J
D45	Thrust washer .082"	output shaft	sel	68-81	C5AZ-7A385-H	6237K
C46	Bearing, thrust (1-3 piece)	sun gear	1	68-81	D3AZ-7C096-A	6259X
PUMP PARTS AND PUMPS						
A50	Pump, front assembly 17 spline shaft	small/medium case	1	51-59	AE	6551A-R
A50	Pump, front assembly 29 spline shaft	small/medium case	1	59-67	AE	6551D-R
A50	Pump, front assembly	FMX	1	68-81	AE	6551L-R
A51	Gear set	FMX	1	68-81	AE	K36201
HARD PARTS						
B55	Drum, front/forward	FMX	1	61-73	D2AZ-7A360-C	6211R-R
B56	Spring, diaphragm .073"	FMX (front/forward clutch)	1	68-81	C1AP-7B070-A	6208C
D58	Governor assembly	FMX	1	68-81	D3AZ-7C053-A	6242C-R
D59	Planetary assembly	FMX	1	68-81	C3AZ-7A398-C	6236L-R
D59	Planetary assembly	AMX-BW8-BW12	1	67-72	AE	6236C-R
C60	Drum, rear/direct	FMX	1	68-79	C9AZ-7A626-A	6229L-R
n/i	Spring (silver)	FMX (helps with hanging governor valve)	1	68-81	D2AZ-7C063-A	6242CS
SPRAGS						
D57	Sprag (roller type)		1	68-81	C3AZ-7A089-A	34402A
NOTES						

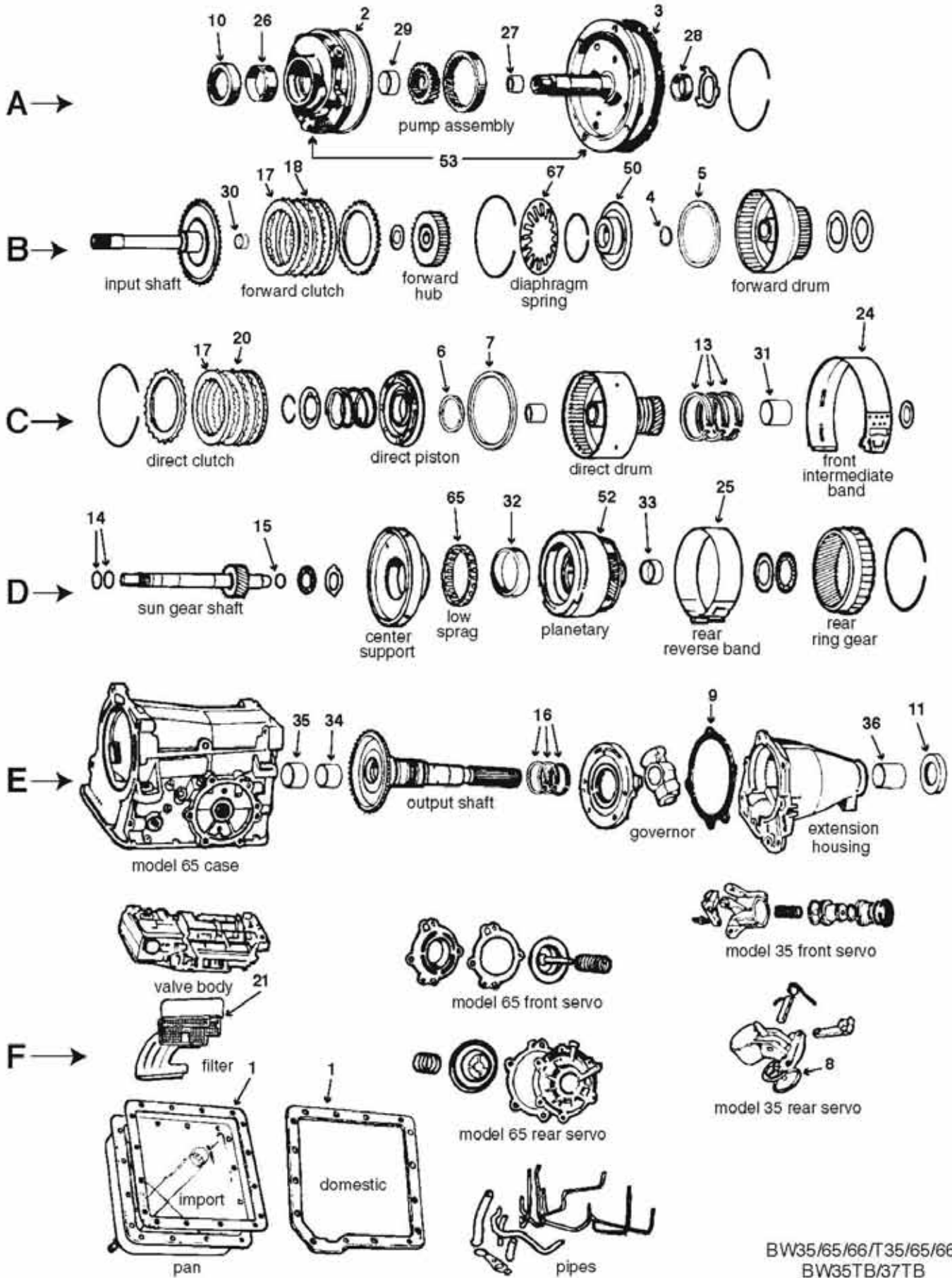

BW35/65/66/T35/65/66
 BW35TB/37TB
 19000/47000/58000

ILL	DESCRIPTION	QTY	YEAR	REFERENCE #	PART #
REBUILDER KITS					
K4	Master deluxe rebuild kit (w/o rear seal) BW35/T35/type 2 USA	1	62-71	AE	K1900B-R
K4	Master deluxe rebuild kit (w/o rear seal) BW35/T35/type 1 non USA	1	63-76	AE	K1900X-R
K4	Master deluxe rebuild kit BMW T65/66	1	73-76	AE	K4700-R
K4	Master deluxe rebuild kit Jaguar T65/66	1	79-88	AE	K4700A-R
K5	Master kit w/steels (w/o rear seal) BW35/T35/type 2 USA	1	62-71	AE	K1900B
K5	Master kit w/steels (w/o rear seal) BW35/T35/type 1 non USA	1	63-76	AE	K1900X
K5	Master kit w/steels BMW T65/66	1	73-76	AE	K4700
K5	Master kit w/steels Jaguar T65/66	1	79-88	AE	K4700A
K5	Master kit w/steels Saab BW35TB(type 5)	1	68-80	AE	K5800
K5	Master kit w/steels Saab 900/9000 BW37TB	1	81-93	AE	K5800A
K6	Master kit w/o steels (w/o rear seal) BW35/T35/type 2 USA	1	62-71	AE	K1900B-LS
K6	Master kit w/o steels (w/o rear seal) BW35/T35/type 1 non USA	1	63-76	AE	K1900X-LS
K6	Master kit w/o steels BMW T65/66	1	71-76	AE	K4700-LS
K6	Master kit w/o steels Jaguar T65/66	1	73-88	AE	K4700A-LS
K6	Master kit w/o steels Saab BW35TB (type 5)	1	68-80	AE	K5800-LS
K6	Master kit w/o steels Saab 900/9000 BW37TB	1	81-93	AE	K5800A-LS
K7	O/H gasket set w/seals-rings BW35/T35/type 2 USA	1	62-71	AE	K19900B
K7	O/H gasket set w/seals-rings BW35/T35/type 1 non USA (w/o rear seal)	1	63-76	AE	K19900X
K7	O/H gasket set w/seals-rings BMW T65/6	1	71-86	AE	K47900
K7	O/H gasket set w/seals-rings Jaguar T65/66	1	73-88	AE	K47900A
K7	O/H gasket set w/seals-rings Saab BW35TB/type 5	1	68-80	AE	K58900
K7	O/H gasket set w/seals-rings Saab 900/9000 BW37TB	1	81-93	AE	K58900A
K11	Gasket and seal kit BW35/T35/type 2 USA	1	62-71	AE	K19900A-1
K11	Gasket and seal kit BW35/T35/type 1 non USA	1	63-76	AE	K19900-1X
K11	Gasket and seal kit BMW/Jaguar T65/66	1	71-88	AE	K47900-1
GASKETS AND RUBBER COMPONENTS					
F1	Gasket, oil pan BW35/T35/type 2 USA (neoprene/cork)	1	62-71	3164825	3744LX
F1	Gasket, oil pan BW35/T35/type 2 USA (Duraprene®)	1	62-71	3164825	3744D
F1	Gasket, oil pan BW35/T35/type 1 non USA (neoprene/cork)	1	63-76	211E7A191	3740LX
F1	Gasket, oil pan BW35/T35/type 1 non USA (Duraprene®)	1	63-76	D1RY-7A191-A	3740D
F1	Gasket, oil pan T65/66 (neoprene/cork)	1	73-88	04650-45008V	3745LX
F1	Gasket, oil pan T65/66 (Duraprene®)	1	73-88	04650-45008V	3745D
A2	Seal, lathe cut BW35/T35/type 1/2/T65/66 (front pump body)	1	62-88	3165004	3822L
A3	Gasket, front pump BW35/T35/type 1/2	1	62-76	3164869	3823L
A3	Gasket, front pump Jaguar/BMW T65/66	1	73-93	046-504-5007Y	3824L
B4	Seal, lathe cut exc 70-71 type 2 (frt cl piston inner)	1	62-88	3165013	3826L
B5	Seal, lathe cut BW35/T35/type 1/2 (frt cl piston outer)	1	62-88	3165012	3825L
C6	O'ring exc 70-71 type 2 (rear cl piston inner)	1	62-88	3165050	3831L
C6	O'ring BW35/T35/type 2 (rear cl piston inner)	1	70-71	3198561	13296
C7	Seal, lathe cut BW35/T35/type 1/2 (rear cl piston outer)	1	62-88	3165009	3829L
F8	O'ring BW35/T35/type 1/2 (rear servo piston)	1	62-93	3165014	3821L
E9	Gasket, extension housing 7/16" holes	1	62-71	3170362	13930
E9	Gasket, extension housing 5/16" holes	1	71-93	3164899	13930A
n/i	O'ring TV cable	1	62-66	3163632	3566
n/i	O'ring manual lever shaft	1	62-69	3187389	3499L
METAL CLAD SEALS					
A10	Seal, metal clad Jaguar BW35/type 1/2/T65/66 (front)	1	62-71	3183886	19605
A10	Seal, metal clad BW65/66/T65/66 (front narrow)	1	71-93	04650-44001	47200
E11	Seal, metal clad (w/flange w/o boot) extension housing (w/inclosed drive line)	1	63-65	3155168	4743C
E11	Seal, metal clad extension housing (Volvo)	1	63-75	D2RY-70502-B	19677
E11	Seal, metal clad 60x38x12mm Studebaker extension housing (model 01)	1	62-88	1251450	8850B
E11	Seal, metal clad 1.950" od (not in kit) Opel/Holden/Vauxhal/Jag extension hsg	1	63-88	235728-3	47201A
E11	Seal, metal clad BMW BW65/66/T65/66 (extension housing)	1	73-76	046-504-4002H	47201

BW35•T35•BW35TB•BW37TB•BW65•BW66

BW35•T35•BW35TB•37TB•BW65•66

ILL	DESCRIPTION	QTY	YEAR	REFERENCE #	PART #	
METAL CLAD SEALS (CONTINUED)						
n/i	Seal, metal clad	BW65/66/T65/66 (manual lever shaft)	1	62-88	3154112	19675
SEALING RINGS						
K10	Kit, sealing ring	BW35/65/66/T35/65/66	1	62-88	AE	K19903B
C13	Ring, sealing	rear clutch drum	3	62-69	3164858	19215
D14	Ring, sealing	forward clutch (front sun gear) (small)	2	69-88	3165007	19216
D14	Ring, sealing	forward clutch (front sun gear) (large)	2	69-88	3186586	6235
D15	Ring, sealing	rear sun gear	1	62-65	3165008	19217
D15	Ring, sealing (teflon)	rear sun gear	1	66-88	3176130	19217A
E16	Ring, sealing	output shaft	3	62-88	3165806	19504
CLUTCH PLATES						
B17	Friction .061" 4.248" od 36T	forward clutch (front)	4/5	62-88	3198571	19206A
C17	Friction .061" 4.248" od 36T	direct clutch (rear)	4/5	62-88	3198571	19206A
B18	Steel .068" 3.134" id 40T	forward clutch (front)	3/4	62-88	3164873	19205
B18	Steel .090" 3.134" id 40T (oversized)	forward clutch (front)	ar	62-88	31648730S	19222X
B18	Steel .053" 3.134" id 40T (undersized)	forward clutch (front)	ar	62-88	3164873US	19205X
C20	Steel, dished .068" 3.125" id 40T	direct clutch (rear)	4/5	62-88	3164863	19222
C20	Steel .090" 3.134" id 40T (oversized)	direct clutch (rear)	ar	62-88	31648730S	19222X
C20	Steel .053" 3.134" id 40T (undersized)	direct clutch (rear)	ar	62-88	3164873US	19205X
FILTERS						
K9	Kit, filter (w/o shroud)	BW35/T35/type 2 USA (neoprene/cork)	1	62-66	AE	FK19755
K9	Kit, filter (w/o shroud)	BW35/T35/type 2 USA (Duraprene®)	1	62-66	AE	DK19755
K9	Kit, filter (w/shroud)(pistol grip type)	BW35/T35 USA (neoprene/cork)	1	67-71	AE	FK19757
K9	Kit, filter (w/shroud)(pistol grip type)	BW35/T35 USA (Duraprene®)	1	67-71	AE	DK19757
K9	Kit, filter (pistol grip type)	BW65/66/T65/66 (neoprene/cork)	1	71-88	AE	FK47800
K9	Kit, filter (pistol grip type)	BW65/66/T65/66 (Duraprene®)	1	71-88	AE	DK47800
F21	Filter screen (w/o shroud)	BW35/T35/type 1/2 (front)	1	62-66	3179973	19755
F21	Filter screen (w/shroud)	BW35/T35 (pistol grip type)(front)	1	67-71	3188896	19757
n/i	Filter screen (w/o shroud)	BW35/T35 (rear)	1	62-66	3164950	19756
n/i	Filter screen (w/shroud)	BW35/T35 (rear)	1	62-66	n/a	19756A
MODULATORS						
n/i	Mod type 2 adj screw in (brown)	AMC BW35/T35	1	61-71	4485870	19510A
BANDS						
C24	Band, flex type (1 17/32" wide)	front	1	62-88	3193718	19313F
C24	Band, solid (1 3/16" wide)	front	1	73-86	3188603	19313C
D25	Band, solid	will fit both front/rear	1	62-88	3187096	19313D
BUSHINGS						
K13	Kit, bushing	BW35/T35/type 1 non USA and type 2 USA	1	62-88	AE	K19902
A26	Bushing	BW35/T35/type 1/2 front pump body	1	62-88	3205306	19003
A27	Bushing	stator support (22 and 23 splines)(front)	1	62-88	3205309	19011
A27	Bushing	stator support (26 splines)(front)	1	69-88	19011A	19011A
A28	Bushing	BW35/T35/type 1/2 (stator support)(rear)	1	62-88	3205307	19009
A29	Bushing	BW35/T35/type 1/2 (front pump drive gear)	1	62-88	3205308	19006
B30	Bushing	BW35/T35/type 1/2 (input shaft)	1	62-88	3205301	19005
C31	Bushing	BW35/T35/type 1/2 (sun gear to rr cl drum)	1	62-88	3205303	19010
C32	Bushing	BW35/T35/type 1/2 (planetary support)	1	62-88	3205304	19008
E34	Bushing	BW35/T35/type 1/2 (output shaft)	1	62-88	3205305	19012
E35	Bushing	BW35/T35/type 1/2 (case)	1	62-88	3203639	19001
E36	Bushing 1.795" od .875" wide	extension housing (w/closed drive line)	1	62-65	3202124	19002A
E36	Bushing (babbitt)	BW35/T35/type 2 (hsg w/open dr line)	1	62-88	3203640	6014
E36	Bushing 1 5/16" od	Volvo/Datsun (extension housing)	1	63-75	235878-6	19002X

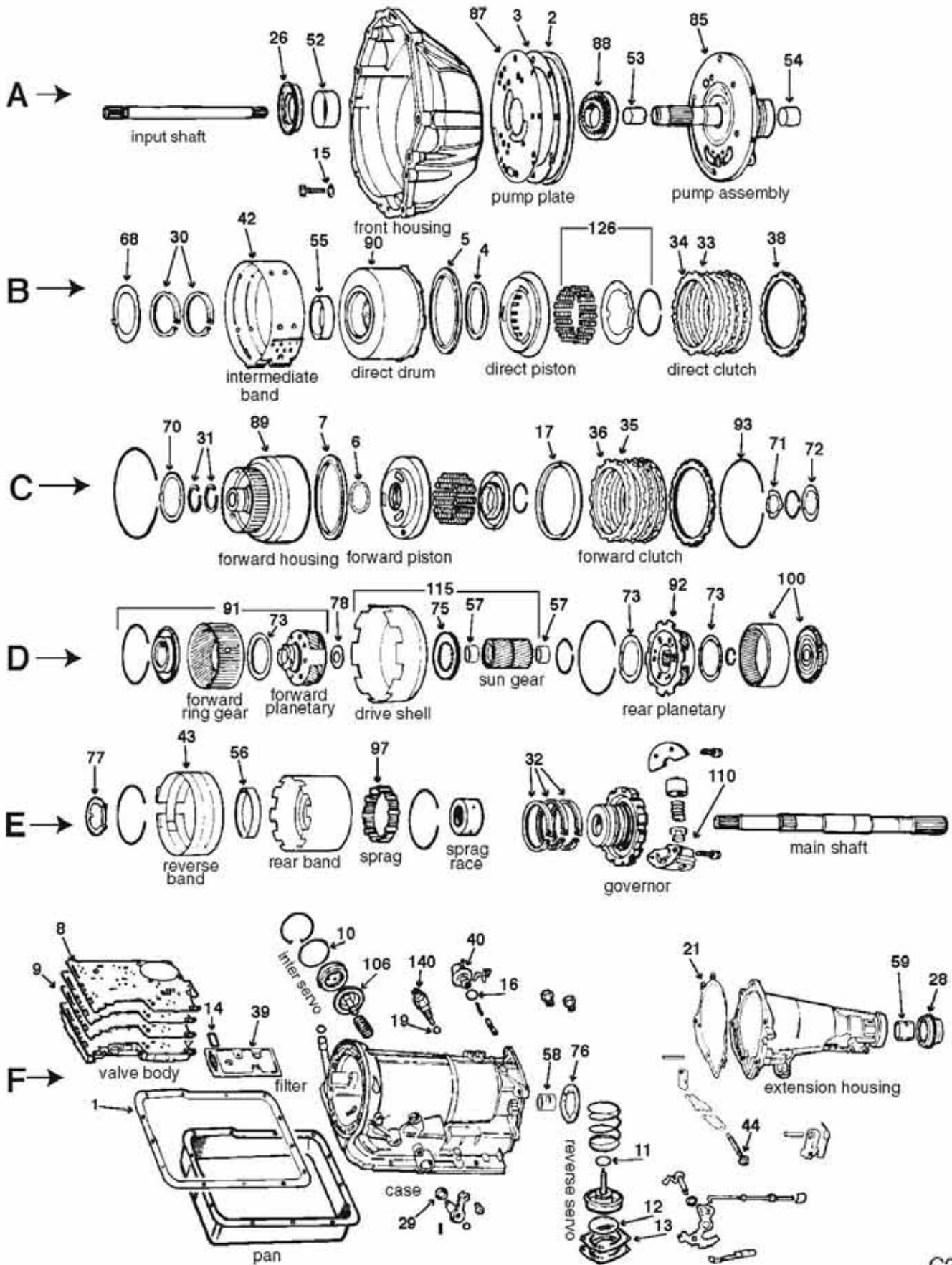

C3
27000

ILL	DESCRIPTION	QTY	YEAR	REFERENCE #	PART #	
REBUILDER KITS						
K4	Master deluxe rebuild kit	C3	1	74-77	AE	K2700-R
K4	Master deluxe rebuild kit	C3	1	78-87	AE	K2700A-R
K5	Master kit w/steels	C3	1	74-77	AE	K2700
K5	Master kit w/steels	C3	1	78-87	AE	K2700A
K6	Master kit w/o steels	C3	1	74-87	AE	K2700-LS
K7	O/H gasket set w/seals-rings	C3	1	74-87	AE	K27900B
K8	External seal kit	C3	1	74-87	AE	K27900-2
K11	Gasket and seal kit	C3	1	74-87	AE	K27900B-1
K28	Kit, reverse servo D'ring	C3	1	74-87	AE	K27900-3
VALVE BODY KITS						
K15	Shift Kit® passenger car and truck	C3	1	74-89	SK® C3	K27908
GASKETS AND RUBBER COMPONENTS						
F1	Gasket, oil pan	neoprene/cork	1	74-87	D5ZZ-7A191-B	13700X
F1	Gasket, oil pan	Duraprene®	1	74-87	D5ZZ-7A191-B	13700D
A2	Seal, lathe cut	pump to case	1	74-87	D5ZZ-7A248-A	13701
A3	Gasket	pump plate to case	1	74-87	E5TZ-7A136-B	13702
B4	Lip seal	direct clutch piston (inner)	1	74-76	E8TZ-7D404-A	13713
B4	Seal, lathe cut	direct clutch piston (inner)	1	77-87	D7ZZ-7D404-A	13713A
B5	Lip seal	direct clutch piston (outer/except 4.0L)	1	74-76	E8TZ-7A548-A	13714
B5	Seal, lathe cut	direct clutch piston (outer)	1	77-87	D7ZZ-7A548-A	13714A
C6	Seal, lathe cut	forward clutch piston (inner)	1	74-87	D4ZZ-7A548-B	13711
C7	Seal, lathe cut	forward clutch piston (outer)	1	74-87	D4ZZ-7A548-A	13712
F8	Gasket, valve body	upper	1	74-87	D4ZZ-7D100-B	13704
F9	Gasket, valve body	lower	1	74-87	D4ZZ-7D100-A	13705
F10	Seal, lathe cut	intermediate servo cover	1	74-87	D4ZZ-7D040-A	13706
F11	O'ring	rear servo piston (small)	1	74-87	D4ZZ-7423-B	3435L
F12	O'ring	rear servo piston (large)	1	74-87	D4ZZ-7423-A	13715
F13	Gasket	rear servo cover	1	74-87	D4ZZ-7L173-A	13708
F14	Gasket, rubber (seal)	filter	1	74-87	D4ZZ-7E062-A	13703
A15	Washer	pump bolt	8	74-87	E830124-S	13718
F16	O'ring	modulator	1	74-87	D853110-S	13707
C17	Rubber cushion	forward clutch	1	78-87	D8ZZ-7B070-A	13740
F19	O'ring	neutral safety switch	1	74-87	E853116-S	13710
F21	Gasket	extension housing	1	74-87	D4ZZ-7086-B	13709
n/i	O'ring	filler tube to case	1	74-87	87034-S94	3291L
n/i	O'ring	speedometer housing	1	74-87	87036-S94	3410L
n/i	O'ring	throttle valve shaft	1	74-87	386078-S	3499L
n/i	O'ring	oil cooler tubes	4	74-87	380892-S94	13327
n/i	Ball, check .250" od (viton)	valve body	5	74-87	E0AZ-7E195-A	13924
METAL CLAD SEALS						
A26	Seal, metal clad	front	1	74-87	D4ZZ-7A248-A	27601A
F28	Seal, metal clad (w/o boot)	extension housing	1	74-87	D5ZZ-7052-A	27695
F28	Seal, metal clad (w/o boot)	extension housing	1	74-87	E2ZZ-7052-A	27695
F29	Seal, metal clad	manual lever shaft	1	74-87	D5ZZ-7B498-A	6507A
SEALING RINGS						
K10	Kit, sealing ring		1	74-87	AE	K27901
B30	Ring, sealing	direct drum	2	74-87	D4ZZ-7D025-A	27228
C31	Ring, sealing (metal)	forward drum	2	74-87	D4ZZ-7D019-A	27227
E32	Ring, sealing (seal plated)	governor	3	74-87	F0TZ-7D011-A	27645

ILL	DESCRIPTION	QTY	YEAR	REFERENCE #	PART #
CLUTCH PLATES					
B33	Friction .075" 4.891" od 48T direct clutch	4/5	74-87	E3ZZ-7B164-B	27304
B34	Steel .078" 3.970" id 20T direct clutch	4/5	74-78	D4ZZ-7B442-B	27305
B34	Steel .068" 3.969" id 20T direct clutch	4/5	78-87	D8ZZ-7B442-B	27305A
B34	Steel .100" 3.969" id 20T (oversized) direct clutch	ar	74-87	D4ZZ-7B442-BOS	27305X
C35	Friction .075" 4.652" od 72T forward clutch	3/5	74-87	E3ZZ-7B164-A	27404
C36	Steel .078" 3.800" id 19T forward clutch	3/5	74-78	D4ZZ-7B442-A	27505
C36	Steel .068" 3.801" id 19T forward clutch	4/5	78-87	D8ZZ-7B442-A	27505A
C36	Steel .100" 3.801" id 19T (oversized) forward clutch	ar	74-87	D4ZZ-7B442-AOS	27505X
PRESSURE PLATES					
C37	Pressure plate .202" 19T forward clutch	1	74-87	D4ZZ-7B066-A	27307-R
B38	Pressure plate .202" 20T direct clutch	1	74-87	D4ZZ-7B066-B	27307A-R
FILTERS					
K9	Kit, filter neoprene/cork	1	74-87	AE	FK27800
K9	Kit, filter Duraprene®	1	74-87	AE	DK27800
F39	Filter	1	74-87	D4ZZ-7A098-A	27800
MODULATORS					
F40	Modulator (white stripe) SAD (6 cylinder)	1	81-87	E1SZ-7A377-A	27830B
F40	Modulator SAD	1	74-87	D6ZZ-7A377-A	27830A
F40	Modulator DAD	1	74-76	D4ZZ-7A377-B	27830
F40	Modulator (black stripe) SAD (4 cylinder)	1	81-87	E1ZZ-7A377-B	27830D
F40	Modulator (green stripe) SAD (6 cylinder)	1	81-87	E1SZ-7A377-C	27830C
BANDS					
B42	Band, flex intermediate	1	74-87	E8TZ-7D034-A	27320F
E43	Band, rigid reverse	1	74-87	E3ZZ-7D095-A	27520A
E43	Band, rigid reverse	1	74-87	E3ZZ-7D095-A	27520A-R
F44	Nut, band adjusting (w/seal) coarse thread	1	74-87	380850-S	26610
BUSHINGS					
K13	Kit, bushing	1	74-87	AE	K27905
A52	Bushing (bronze) front/bell housing	1	74-87	n/a	27001A
A52	Bushing (babbitt) front/bell housing	1	74-87	n/a	27001B
A52	Bushing (seal-sure) front/bell housing	1	74-87	56001SS	27001X
A53	Bushing pump assembly (front)	1	74-87	n/a	27000
A54	Bushing pump assembly (rear)	1	74-87	n/a	27000A
B55	Bushing direct drum (cast iron drum only)	1	74-87	n/a	27002
B55	Bushing (bronze) direct drum	1	85-87	90DT-7D046-A	27002B
E56	Bushing reverse drum (except 4.0L)	1	74-87	n/a	27004
D57	Bushing sun gear	2	74-87	74DT-7D065-AA	27003
F58	Bushing case	1	74-87	n/a	27005
F59	Bushing extension housing	1	74-87	D7FZ-7A034-A	16001A
WASHERS/BEARINGS/RACES/SHIMS					
K14	Kit, thrust washer w/o selective	1	74-87	AE	K27907
B68	Thrust washer (metal) .055" pump to center support	sel	74-87	D4ZZ-7D014-A	27209A
B68	Thrust washer (plastic) .063" (#2) pump to center support	sel	74-87	D4ZZ-7D014-B	27209B
B68	Thrust washer (plastic) .078" (#3) pump to center support	sel	74-87	D4ZZ-7D014-C	27209C
B68	Thrust washer (plastic) .094" (#4) pump to center support	sel	74-87	D4ZZ-7D014-D	27209D
B68	Thrust washer (plastic) .109" (#5) pump to center support	sel	74-87	D4ZZ-7D014-E	27209E
C70	Thrust washer direct drum	1	74-87	D4ZZ-7C096-A	27210
C71	Thrust washer (3 tabs) forward housing to forward planetary	1	74-87	D4ZZ-7D090-A	27211A
C72	Thrust washer (4 tabs) forward housing to forward ring gear hub	1	74-87	D4ZZ-7D090-B	27211
D73	Thrust washer (6 tabs outer) front/rear w/aluminum planetary to hub	3	74-87	D4ZZ-7A166-A	27213
D75	Thrust washer (metal) 27T internal drive shell to sun gear	1	74-87	D4ZZ-7D066-A	27215
F76	Thrust washer case to park gear	1	74-87	D4ZZ-7B368-B	27216
E77	Thrust washer rear ring gear hub to case	1	74-87	D4ZZ-7D422-A	27218



ILL	DESCRIPTION		QTY	YEAR	REFERENCE #	PART #
WASHERS/BEARINGS/RACES/SHIMS (CONTINUED)						
D78	Race, thrust bearing	thrust bearing w/open face to sun gear	1	74-87	F3TZ-7D234-A	27219-R
SNAP RINGS						
C93	Snap ring .096"	forward clutch	1	74-87	E860115-S	27510C
PUMP PARTS AND PUMPS						
A85	Pump assembly		1	74-87	D6ZZ-7A103-A	27200-R
A87	Plate, pump		1	74-87	D4ZZ-7B472-A	27202
A88	Gear set	pump	1	74-87	4DT-7L201	K27201
HARD PARTS						
C89	Drum, forward (6 clutch)	C3	1	78-87	E5TZ-7A360-A	27400B-R
B90	Drum, direct (4 clutch stamped steel)	C3	1	74-87	E5TZ-7D044-F	27300C-R
B90	Drum, direct (5 clutch stamped steel)	C3	1	85-87	E5TZ-7D044-E	27300G-R
D91	Planetary (3 pinion aluminum)	front/forward	1	74-87	D4ZZ-7A398-A	27412-R
D91	Planetary (6 pinion steel w/ring gear hub)	front/forward	1	85-87	E7TZ-7A398-A	27412A-R
D92	Planetary (aluminum)	rear/reverse	1	74-77	D4ZZ-7D006-A	27448-R
D92	Planetary (4 pinion steel)	rear/reverse	1	78-87	E7SZ-7D007-B	27448A-R
D100	Hub, rear	C3	1	74-87	D4ZZ-7A153-A	27427-R
E110	Governor assembly	C3	1	80-87	D8ZZ-7C063-A	27615A-R
D115	Shell, drive (w/sun gear)	early	1	74-85	D4ZZ-7D064-A	27728-R
B126	Set, retainer w/springs	direct clutch	1	74-87	K56850	K27301
ELECTRICAL COMPONENTS						
D140	Switch, neutral safety (4 pins)		1	74-87	D4ZZ-7A247-B	15A-264-R
SPRAGS						
E97	Kit, spring/roller (w/retainer)	rear (except 4.0L)	1	74-87	D4ZZ-7D191-A	K27960
BONDED PISTONS						
F106	Piston 2.100" (bonded rubber)	intermediate servo cover AA/AB	1	74-80	D4ZZ-7D021-A	27528
F106	Piston 1.945" (bonded rubber)	intermediate servo cover BB	1	75-87	D8DZ-7D021-A	27528B
NOTES						

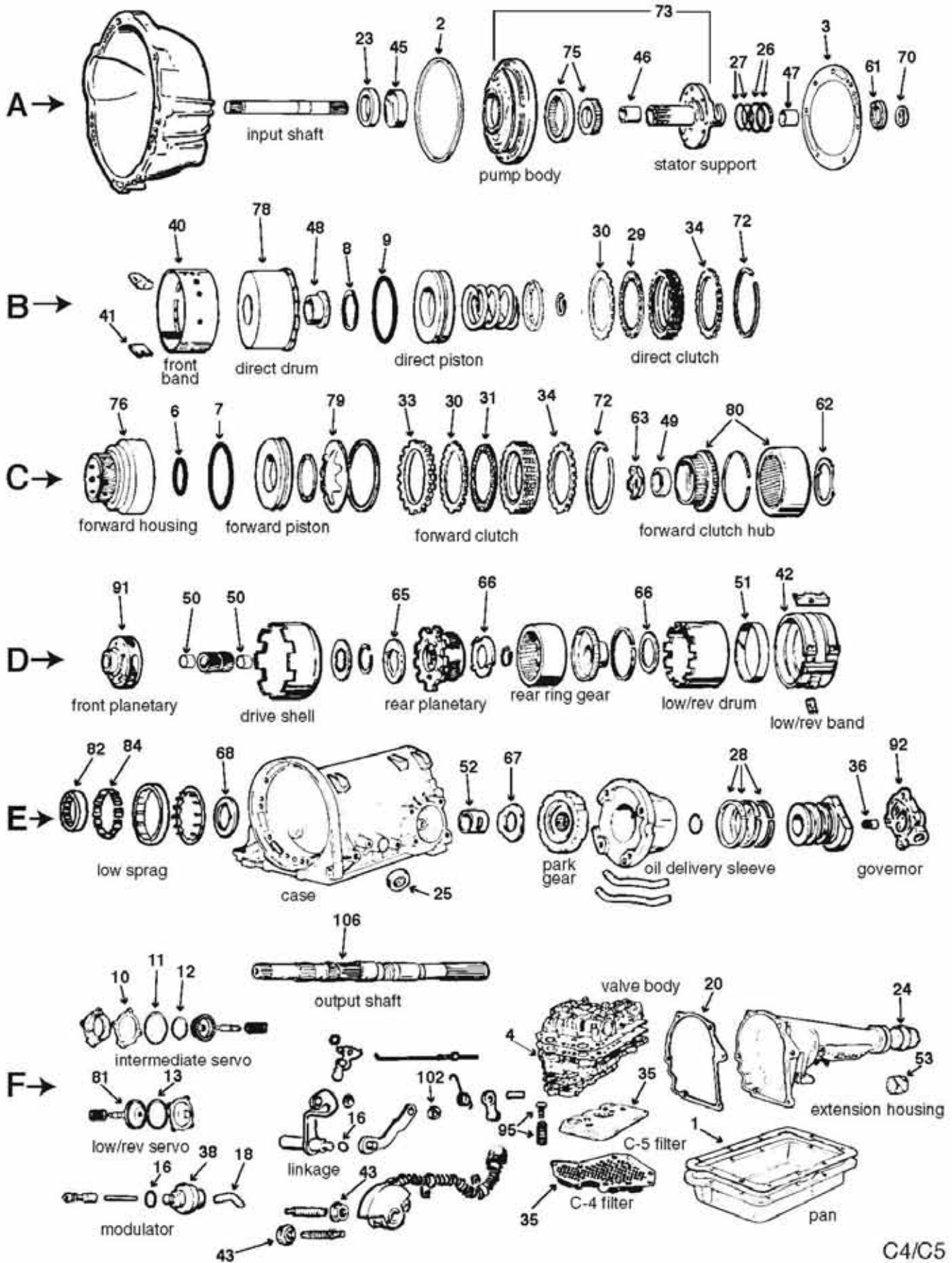

C4/C5
26000/M

ILL	DESCRIPTION	QTY	YEAR	REFERENCE #	PART #
TECHNICAL MANUALS					
K53	Tech manual C4/C5 dis/assembly	1	64-86	83-C5TM	010-201
REBUILDER KITS					
K4	Master deluxe rebuild kit	1	64-69	AE	K2600C-R
K4	Master deluxe rebuild kit	1	70-77	AE	K2600D-R
K4	Master deluxe rebuild kit	1	78-81	AE	K2600F-R
K4	Master deluxe rebuild kit	1	82-86	AE	K2600M-R
K4	Master deluxe rebuild kit	1	70-77	AE	H2600D-R
K5	Master kit w/steels	1	64-69	AE	K2600C
K5	Master kit w/steels	1	70-77	AE	K2600D
K5	Master kit w/steels	1	78-81	AE	K2600F
K5	Master kit w/steels	1	82-86	AE	K2600M
K6	Master kit w/o steels	1	64-69	AE	K2600C-LS
K6	Master kit w/o steels	1	70-77	AE	K2600D-LS
K6	Master kit w/o steels	1	78-81	AE	K2600F-LS
K6	Master kit w/o steels	1	82-86	AE	K2600M-LS
K7	O/H gasket set w/seals-rings	1	64-69	AE	K26900C
K7	O/H gasket set w/seals-rings	1	70-77	AE	K26900D
K7	O/H gasket set w/seals-rings	1	78-81	AE	K26900F
K7	O/H gasket set w/seals-rings	1	82-86	AE	K26900M
K8	External seal kit	1	64-86	AE	K26900-2
K11	Gasket and seal kit	1	64-69	AE	K26900C-1
K11	Gasket and seal kit	1	70-77	AE	K26900D-1
K11	Gasket and seal kit	1	82-86	AE	K26900M-1
VALVE BODY KITS					
K15	Shift Kit® passenger car	1	64-64	SK® 4	K26908
K15	Shift Kit® passenger car	1	65-66	SK® 4L	K26908A
K15	Shift Kit® passenger car	1	67-67	SK® 4S	K26908B
K15	Shift Kit® passenger car	1	67-69	SK® 4SL	K26908C
K15	Shift Kit® passenger car	1	70-72	SK® 71	K26908E
K15	Shift Kit® passenger car and truck	1	73-86	SK® C5	K26908F
K15	Reprogramming Kit™	1	67-69	47-2	47-2
K15	Reprogramming Kit™	1	70-81	40-2	40-2
K15	Reprogramming Kit™ stick shift	1	70-81	40-3	40-3
K15	Shift Improver Kit	1	67-69	50260	114-50260
K15	Shift Improver Kit	1	70-82	50262	114-50262
K15	Transpak™	1	64-66	50227	114-50227
K15	Transpak™	1	70-82	50229	114-50229
GASKETS AND RUBBER COMPONENTS					
F1	Gasket, oil pan	1	64-86	D60Z-7A191-A	13265X
F1	Gasket, oil pan	1	64-86	D0DZ-7A191-B	13265D
A2	O'ring	1	64-66	376950-S	3971L
A3	Gasket	1	64-86	E1AZ-7A136-A	13261
F4	Gasket, valve body separator plate	1	65-66	C5AZ-7D100-B	13215
F4	Gasket, valve body separator plate	1	67-69	E2DZ-7F49-A	13281
F4	Gasket, valve body separator plate	1	70-80	D40P-7D100-A/B	13302
F4	Gasket, valve body separator plate	1	70-81	D7FZ-7D100-A	13305
F4	Gasket, valve body separator plate	1	82-86	E3DZ-7D100-A	13313
C6	O'ring	1	64-70	B5AZ-7A294-E	3366AL
C6	O'ring	1	70-86	D0AZ-7A294-A	13329
C7	Seal, lathe cut	1	64-78	C4AZ-7A548-C	3930L
C7	Lip seal	1	79-86	D80P-7A548-AA	13328
B8	O'ring	1	64-67	B5AZ-7A294-E	3366AL
B8	Seal, lathe cut	1	68-86	D0AZ-7D404-A	13263

ILL	DESCRIPTION	QTY	YEAR	REFERENCE #	PART #
GASKETS AND RUBBER COMPONENTS (CONTINUED)					
B9	Seal, lathe cut C4 (direct clutch piston outer)	1	64-81	C8AZ-7A548-B	3929L
B9	Lip seal C4/C5 (direct clutch piston outer)	1	81-86	E1AZ-7A548-A	3932L
F10	Gasket C4/C5 (intermediate servo cover)	1	64-86	C4AZ-7D026-C	13259
F11	Seal, lathe cut 3.390" id C4 (intermediate servo piston large)	1	64-81	D5TZ-7D024-A	3934L
F11	Seal, lathe cut 2.869" id C4 (intermediate servo piston large)	1	72-81	D2DZ-7D024-A	13475
F11	O'ring 3.489" id C5 (intermediate servo piston large)	1	81-83	E1AZ-7D024-A	3941L
F12	Seal, lathe cut 2.381" id C4/C5 (intermediate servo piston small)	1	64-85	D9AZ-7D025-A	13240
F12	Seal, lathe cut 2.505" id C4 (intermediate servo piston small)	1	64-80	D5TZ-7D025-A	13243
F12	Seal, lathe cut 2.582" id C4 (intermediate servo piston small)	1	68-72	C8CZ-7D025-A	13282
F12	O'ring 2.550" id C5 (intermediate servo piston small)	1	81-86	E1AZ-7P025-A	13224
F12	O'ring 2.250" id (red stripe) C5 (intermediate servo piston small)	1	82-86	E2SZ-7D025-A	13862
F12	O'ring 2.362" id C5 (intermediate servo piston small)	1	82-86	E2DZ-7D025-A	13244
F13	Seal, lathe cut C4/C5 (rear servo cover)	1	64-86	D0FZ-7D040-A	13325
F16	O'ring C4/C5 (throttle valve shaft)	1/2	64-86	386078-S	3499L
F16	Gasket C4 (vacuum modulator screw in)	1	64-71	C1AP-7BH26-A	3395L
F18	Hose, vacuum (90°) C4/C5	1	64-86	C1AZ-7B087-E	13566
F20	Gasket C4/C5 (extension housing)	1	64-86	C4AZ-7086-C	3939L
n/i	Gasket C5 (auxiliary valve body)	1	82-86	E2DZ-7F497-A	13314
n/i	Ball, check .218" od (viton) C4/C5	2/4	64-86	C7AZ-7E195-A	13923
n/i	O'ring C4/C5 (filler tube to case)	1	64-86	87034-S94	3291L
n/i	O'ring C4/C5 (speedo to case)	1	64-86	87036-S94	3410L
n/i	O'ring C4/C5 (oil cooler tubes)	4	65-86	380892-S94	13327
n/i	Check valve (hockey puck) C4 (intermediate servo accumulator)	1	64-80	C5AZ-7D376-A	13222
n/i	Gasket (metal) C4 (filter)	1	70-81	D3BZ-7E062-A	13326
METAL CLAD SEALS					
A23	Seal, metal clad (w/o flange) front	1	64-86	C2AZ-7A248-A	16601B
F24	Seal, metal clad with bolt on yoke	1	64-72	C4UZ-7052-A	16695F
F24	Seal, metal clad 60x38x10mm (w/boot) rear (extension housing)	1	64-86	D5AZ-7052-B	16695E
F24	Seal, metal clad 60x38x12mm rear (extension housing)	1	64-86	D5AZ-7052-BNF	8850B
E25	Seal, metal clad manual lever shaft	1	64-86	D5ZZ-7B498-A	6507A
SEALING RINGS					
K10	Kit, sealing ring C4 (7 metal rings)	1	64-69	AE	K26901
K10	Kit, sealing ring C4 (7 metal rings)	1	70-77	AE	K26901A
K10	Kit, sealing ring C4/C5 (7 metal rings)	1	78-86	AE	K26901C
A26	Ring, sealing C4 (stator support to forward drum)	2	64-69	C4AZ-7D019-B	26225
A26	Ring, sealing C4 (stator support to forward drum)	2	70-77	D0AZ-7A019-A	26227
A26	Ring, sealing (metal) 1/8" thick C4/C5 (stator support to forward drum)	2	78-86	D7AZ-7D019-A	26227A
A26	Ring, sealing (teflon) 1/8" thick C4/C5 (stator support to forward drum)	2	78-86	D7AZ-7D019-A	26227AT
A27	Ring, sealing C4 (stator support to direct drum)	2	64-69	C4AZ-7D020-A	26226
A27	Ring, sealing (metal) C4/C5 (stator support to direct drum)	2	70-86	D0AZ-7D020-A	26228
A27	Ring, sealing (teflon) C4/C5 (stator support to direct drum)	2	70-86	D0AZ-7D020-A	26228T
E28	Ring, sealing (metal) C4/C5 (governor)	3	64-86	C4AZ-7D011-A	26645
E28	Ring, sealing (teflon) C4/C5 (governor)	3	64-86	C4AZ-7D011-A	26645T
CLUTCH PLATES					
B29	Friction .090" 4.556" od 42T (waffle) C4 (direct clutch)	3/4	64-64	C4AZ-7B164-D	26304A
B29	Friction .078" 4.556" od 42T (grooved) C4/C5 (direct clutch)	3/4	65-86	E2SZ-7B164-A	26304B
B29	Friction .061" 4.556" od 42T (high performance) C4/C5 (direct clutch)	4/5	64-86	C8AZ-7B164-DHP	26404H
B30	Steel .078" 3.596" id 26T C4/C5 (direct clutch)	3/4	64-86	C4AZ-7B442-B	26305A
B30	Steel .078" 3.596" id 26T (Kolene®) C4/C5 (direct clutch)	3/4	64-86	C4AZ-7B442-BK	26305K
B30	Steel .090" 3.596" id 26T (oversized) C4/C5 (direct clutch)	ar	64-86	E2SZ-7B442-A	26305X
C30	Steel .078" 3.596" id 26T C4/C5 (forward clutch)	4/5	64-86	C4AZ-7B442-B	26305A
C30	Steel .078" 3.596" id 26T (Kolene®) C4/C5 (forward clutch)	4/5	64-86	C4AZ-7B442-BK	26305K
C30	Steel .090" 3.596" id 26T (oversized) C4/C5 (forward clutch)	ar	64-86	E2SZ-7B442-A	26305X

ILL	DESCRIPTION	QTY	YEAR	REFERENCE #	PART #
CLUTCH PLATES (CONTINUED)					
C31	Friction .061" 4.556" od 42T (smooth) C4/C5 (forward clutch)	4/5	64-86	C8AZ-7B164-D	26404B
C31	Friction .061" 4.556" od 42T (high performance) C4/C5 (forward clutch)	4/5	64-86	C8AZ-7B164-DHP	26404H
PRESSURE PLATES					
B33	Pressure plate .267" (beveled) C4 (forward clutch)	1	64-81	C8AZ-7B066-C	26307C-R
B33	Pressure plate .313" (beveled) C5 (forward clutch)	1	81-86	E1AZ-7B066-A	26307E-R
B34	Pressure plate .220" C4 (direct clutch)	1	64-81	C4AZ-7B066-A	26307D-R
C34	Pressure plate .220" C4 (forward clutch)	1	64-81	C4AZ-7B066-A	26307D-R
C34	Pressure plate .297" C4/C5 (forward clutch)	1	82-86	E2SZ-7B066-B	26307G-R
B34	Pressure plate .141" C5 (direct clutch)	1	81-86	E1AZ-7B066-B	26307F-R
C34	Pressure plate .141" C5 (forward clutch)	1	81-86	E1AZ-7B066-B	26307F-R
FILTERS					
K9	Kit, filter C4 (neoprene/cork)	1	64-64	AE	FK26422
K9	Kit, filter C4 (Duraprene®)	1	64-64	AE	DK26422
K9	Kit, filter C4 (neoprene/cork)	1	65-69	AE	FK26422A
K9	Kit, filter C4 (Duraprene®)	1	65-69	AE	DK26422A
K9	Kit, filter C4 (neoprene/cork)	1	70-81	AE	FK26422B
K9	Kit, filter C4 (Duraprene®)	1	70-81	AE	DK26422B
K9	Kit, filter Bronco C4 (neoprene/cork)	1	73-77	AE	FK26422D
K9	Kit, filter Bronco C4 (Duraprene®)	1	73-77	AE	DK26422D
K9	Kit, filter (w/deep pan) C4 (neoprene/cork)	1	74-81	AE	FK26422C
K9	Kit, filter (w/deep pan) C4 (Duraprene®)	1	74-81	AE	DK26422C
K9	Kit, filter C5 (neoprene/cork)	1	82-86	AE	FK26422M
K9	Kit, filter C5 (Duraprene®)	1	82-86	AE	DK26422M
K9	Kit, filter (w/deep pan) C5 (neoprene/cork)	1	83-86	AE	FK26422N
K9	Kit, filter (w/deep pan) C5 (Duraprene®)	1	83-86	AE	DK26422N
F35	Filter (screen) C4	1	64-64	C4AZ-7A098-B	26422
F35	Filter (screen) including 70 Falcon/Maverick	1	65-69	C5AZ-7A098-C	26422A
F35	Filter (screen)(w/shallow pan) C4	1	70-81	D0DZ-7A098-B	26422B
F35	Filter (screen) Bronco	1	73-77	D3BZ-7A098-A	26422D
F35	Filter (screen)(w/deep pan) Bobcat/Mustang/Pinto/Versailles	1	74-81	D4FZ-7A098-A	26422C
F35	Filter (screen) C5	1	82-86	E2DZ-7A098-A	26422M
F35	Filter (screen)(4WD/w/deep pan) C5	1	83-86	E3TZ-7A098-A	26422N
E36	Screen, filter C4/C5 (governor)	1	67-86	C7AZ-7E242-A	26712
MODULATORS					
F38	Modulator (white stripe adjustable) C4 (SAD screw in)	1	64-72	C4AZ-7A377-B	26830
F38	Modulator (yellow stripe adjustable) C4 (SAD push in)	1	72-84	D2AZ-7A377-A	26830C
F38	Modulator (red stripe adjustable) C4 (DAD push in)(substitute SAD ok)	1	73-76	D3OZ-7A377-A	26830B
F38	Modulator (green stripe adjustable) C4/C5 (SAD push in)	1	74-86	D5AZ-7A377-B	26830D
F38	Modulator (blue stripe adjustable) C4 (SAD push in)(250/302 eng)	1	79-81	D9AZ-7A377-A	26830E
F38	Modulator (white stripe adjustable) C5 (SAD push in)	1	82-86	E2TZ-7A377-A	26830F
BANDS					
B40	Band (narrow) C4 (front w/o arrow)	1	64-65	AE	26320A-RL
B40	Band (narrow) C4 (front w/arrow)	1	64-65	AE	26320B-R
B40	Band (wide) C4 (front should use 26320F)	1	66-68	AE	26320D-RL
B40	Band, flex C4/C5 (front)	1	65-86	D9AZ-7D034-A	26320F
B40	Band, flex C4/C5 (front snap band)	1	65-86	AE	26320S
B41	Strut, band C4/C5 (intermediate)	1	65-86	D3AZ-7D029-B	26611-R
D42	Band C4/C5 (rear/reverse)	1	64-86	D0AZ-7D095-A	26520A
D42	Band C4/C5 (rear/reverse)	1	64-86	D0AZ-7D095-A	26520A-R
F43	Nut, band adjusting (w/seal) C4/C5 (coarse thread)	1/2	64-86	380850-S	26610
F43	Nut, band adjusting (w/seal) C5 (fine thread)	1	81-86	389049-S	26610A

C4•C5

C4•C5

ILL	DESCRIPTION	QTY	YEAR	REFERENCE #	PART #
BUSHINGS					
K13	Kit, bushing (complete) C4	1	64-69	AE	K26905
K13	Kit, bushing (complete) C4/C5	1	70-86	AE	K26905A
A45	Bushing (babbit) C4/C5 (pump body)	1	64-86	C0AP-7B258-A	26001A
A45	Bushing (bronze) C4/C5 (pump body)	1	64-86	C0AP-7B258-A	26001C
A46	Bushing C4 (stator front)	1	64-69	C4AZ-7B261-A	26000
A46	Bushing C4/C5 (stator front)	1	70-86	D0AZ-7B261-A	26000C
A47	Bushing C4 (stator rear)	1	64-69	C4AZ-7D018-B	26000B
A47	Bushing C4/C5 (stator rear)	1	70-86	D0AZ-7D018-A	26000D
B48	Bushing C4 (direct drum)	1	64-69	C4AZ-7D046-A	26002
B48	Bushing C4/C5 (direct drum)	1	70-86	D0AP-7D046-B	26002A
C49	Bushing C4/C5 (forward clutch hub)	1	66-86	C6AZ-7E059-A	26008
D50	Bushing C4/C5 (sun gear)	2	64-86	C4AZ-7D065-A	26003
D51	Bushing C4/C5 (low/reverse drum)	1	64-86	C4AZ-7D001-A	26004
E52	Bushing C4/C5 (case rear)	1	64-86	C4AZ-7025-A	26005
F53	Bushing (babbit) C4/C5 (extension housing)	1	64-86	B3TZ-7A034-A	6014
WASHERS/BEARINGS/RACES/SHIMS					
K14	Kit, thrust washer C4/C5 (w/o selectives)	1	64-86	AE	K26902
K14	Kit, thrust washer C4 (w/popular selectives)	1	64-69	AE	K26902A
K14	Kit, thrust washer C4/C5 (w/popular selectives)	1	70-86	AE	K26902B
K14	Kit, thrust washer C4 (pump selectives)	1	64-66	AE	K26906
K14	Kit, thrust washer C4/C5 (pump selectives)	1	66-86	AE	K26906A
K14	Kit, thrust washer C4/C5 (reverse selectives)	1	64-86	AE	K26904
A61	Thrust washer .038"-.042" C4 (pump w/o tangs)	sel	64-66	C4AZ-7D014-A	26209
A61	Thrust washer .053"-.057" C4 (pump w/o tangs)	sel	64-66	C4AZ-7D014-B	26209A
A61	Thrust washer .070"-.074" C4 (pump w/o tangs)	sel	64-66	C4AZ-7D014-C	26209B
A61	Thrust washer .087"-.091" C4 (pump w/o tangs)	sel	64-66	C4AZ-7D014-D	26209C
A61	Thrust washer .106"-.110" C4 (pump w/o tangs)	sel	64-66	C4AZ-7D014-E	26209D
A61	Thrust washer .072" (green plastic #1) C4/C5 (pump w/tangs)	sel	66-86	D0AZ-7D014-A	26209G
A61	Thrust washer .089" (natural plastic #2) C4/C5 (pump w/tangs)	sel	66-86	D0AZ-7D014-B	26209H
A61	Thrust washer .106" (black plastic #3) C4/C5 (pump w/tangs)	sel	66-86	D0AZ-7D014-C	26209J
A61	Thrust washer .123" (yellow plastic #4) C4/C5 (pump w/tangs)	sel	66-86	D0AZ-7D014-D	26209K
A61	Thrust washer .140" (blue plastic #5) C4/C5 (pump w/tangs)	sel	66-86	D0AZ-7D014-K	26209L
C62	Thrust washer C4/C5 (rear clutch hub to front planetary)	1	64-86	C4AZ-7A242-A	26215
C63	Thrust washer (3 tabs) C4 (forward clutch hub)	1	64-69	C4AZ-7D090-A	26401
C63	Thrust washer 1 1/8" id 2 15/16" od C4/C5 (forward clutch hub)(3 tabs)	1	70-86	D0AZ-7D090-A	26401A
D65	Thrust washer C4/C5 (input shell to rear planetary)	1	64-86	C4AZ-7A242-A	26215
D65	Thrust washer 2 3/32" id C4/C5 (input shell to rear planetary)	1	72-86	D20Z-7A242-A	26215A
D66	Thrust washer rear planet to rear ring gear to rev drum	2	64-86	E0AZ-7C096-B	26504
E67	Thrust washer (3 external slots) C4/C5 (park gear)	1	64-86	C4AZ-7B368-A	26609-R
E68	Thrust washer C4/C5 (sprag inner race to case)	1	64-86	E0AZ-7D072-A	26605
A70	Thrust washer .041"-.043" (#1) C4/C5 (stator to forward drum)	sel	64-86	D0AZ-7D091-F	26212
A70	Thrust washer .056"-.058" (#2) C4/C5 (stator to forward drum)	sel	64-86	D0AZ-7D091-B	26212A
A70	Thrust washer .073"-.075" (#3) C4/C5 (stator to forward drum)	sel	64-86	D0AZ-7D091-C	26212B
A70	Thrust washer .090"-.092" (#4) C4/C5 (stator to forward drum)	sel	64-86	D0AZ-7D091-J	26212C
A70	Thrust washer .107"-.109" (#5) C4/C5 (stator to forward drum)	sel	64-86	D0AZ-7D091-K	26212D
n/i	Bearing, ball .825" 3.145" od 1.378" id C4/C5 (extension housing bolt on yoke)	1	64-86	C3AZ-7025-B	6307N
SNAP RINGS					
B72	Snap ring .070"-.080" 5" od C4/C5 (direct clutch)	sel	64-86	D0AZ-7A577-A	26310
B72	Snap ring .060"-.066" 5" od C4/C5 (direct clutch)	sel	64-86	D9AZ-7A577-AS	26310A
B72	Snap ring .088"-.094" 5" od C4/C5 (direct clutch)	sel	64-86	D9AZ-7A577-D	26310B
B72	Snap ring .102"-.106" 5" od C4/C5 (direct clutch)	sel	64-86	D0AZ-7A577-B	26310C
B72	Snap ring 5" od (wave type) C4/C5 (direct clutch)	1	81-86	E1AZ-7A577-A	26310D
C72	Snap ring .070"-.080" 5" od C4/C5 (forward clutch)	sel	64-86	D0AZ-7A577-A	26310

ILL	DESCRIPTION		QTY	YEAR	REFERENCE #	PART #
SNAP RINGS (CONTINUED)						
C72	Snap ring .060"-.066" 5" od	C4/C5 (forward clutch)	sel	64-86	D9AZ-7A577-A	26310A
C72	Snap ring .088"-.094" 5" od	C4/C5 (forward clutch)	sel	64-86	D9AZ-7A577-D/	26310B
C72	Snap ring .102"-.106" 5" od	C4/C5 (forward clutch)	sel	64-86	D0AZ-7A577-B	26310C
C72	Snap ring 5" od (wave type)	C4/C5 (forward clutch)	sel	64-86	E1AZ-7A577-A	26310D
PUMP PARTS AND PUMPS						
A73	Pump assembly (complete)	C4 (exchange)	1	64-69	C4AZ-7A103-G	26200C-R
A73	Pump assembly (complete)	C4 (exchange)	1	70-77	D0AZ-7A103-G	26200D-R
A73	Pump assembly (complete)	C4 (exchange)(wide forward seal rings)	1	70-81	D7AZ-7A103-A	26200E-R
A73	Pump assembly (complete)	C5 (exchange)	1	82-86	E2SZ-7A103-A	26200F-R
A75	Gear set, pump	C4/C5	1	64-86	C4AZ-7C010-F	K26201
HARD PARTS						
C76	Housing, forward 24 spline 5 clutch	C4/C5	1	71-81	D8OZ-7A360-A	26400B-R
B78	Drum, direct 4 clutch	C4/C5	1	70-81	D0AZ-7D044-A	26300D-R
C79	Spring, diaphragm	C4/C5 (forward clutch)	1	64-86	E1AZ-7B070-A	26406
C79	Spring, diaphragm	C4/C5 (forward clutch)	1	64-86	E1AZ-7B070-A	26406-R
C80	Hub, forward clutch	C4/C5	1	65-81	C5AZ-7B067-B	26426A-R
F81	Piston, bonded rubber	C4/C5 (reverse servo)	1	64-86	D1AZ-7D189-A	26528A
E82	Race, inner sprag	C4/C5	1	64-86	D4AZ-7D171-A	26600-R
D91	Planetary, front	C4/C5	1	64-86	C4AZ-7A398-F	26412B-R
E92	Governor assembly (various)	C4/C5	1	64-86	C4AZ-7C063-B	26615A-R
F95	Kit, throttle timing valve and spring	C4/C5	1	70-81	MC4713	K26909
F102	Grommet	C4/C5 (shift lever/large)	1	67-79	26711	96-125
F102	Grommet 5/16" id 1/2" od (not in kit)	C4/C5 (shift lever/small)	1	67-80	D4AZ-7341-A	96-126
F106	Output shaft (4WD 13 1/4")	C4	1	69-81	D3BZ-7060-A	26655-R
n/i	Kit, spring and retainer	C4 (direct clutch)	1	64-69	C4AZ-7A480-C	K26907
n/i	Elbow, brass (w/lock-nut 90°)	C4/C5 (case fitting)	1	64-86	E2SZ-7D273-A	96-110
n/i	Nut, inverted flare 3/8"	C4/C5	1	64-86	391FS-6	96-130
n/i	Nut, inverted flare 5/16"	C4/C5	1	64-86	391FS-5	96-129
n/i	Plug, brass 1/8" w/allen head	C4/C5 (converter)	1	64-86	109AL-2	96-102
n/i	Plug, brass 1/8" w/hex head solid	C4/C5 (converter)	1	64-86	1Z1SD-2	96-133
n/i	Filler tube repair	C4/C5	1	64-86	M99100A	96-140A
n/i	E-Clip 1/4"	C4/C5	1	64-86	203	96-111
n/i	Pin, anti-ballooning	C4	1	64-69	FX-100P	26100
n/i	Bracket, modulator	C4/C5	1	72-86	AE	96-006-R
SPRAGS						
E84	Kit, spring and roller	C4/C5 (12 rollers 12 springs)	1	64-86	C4AZ-7D098-A	K26903A
E84	Retainer w/springs/rollers	C5 (can use K26903A w/retainer)	1	82-86	D8OZ-7D191-A	K26960
BONDED PISTONS						
F81	Piston, bonded rubber	C4/C5 (reverse servo)	1	64-86	D1AZ-7D189-A	26528A
NOTES						

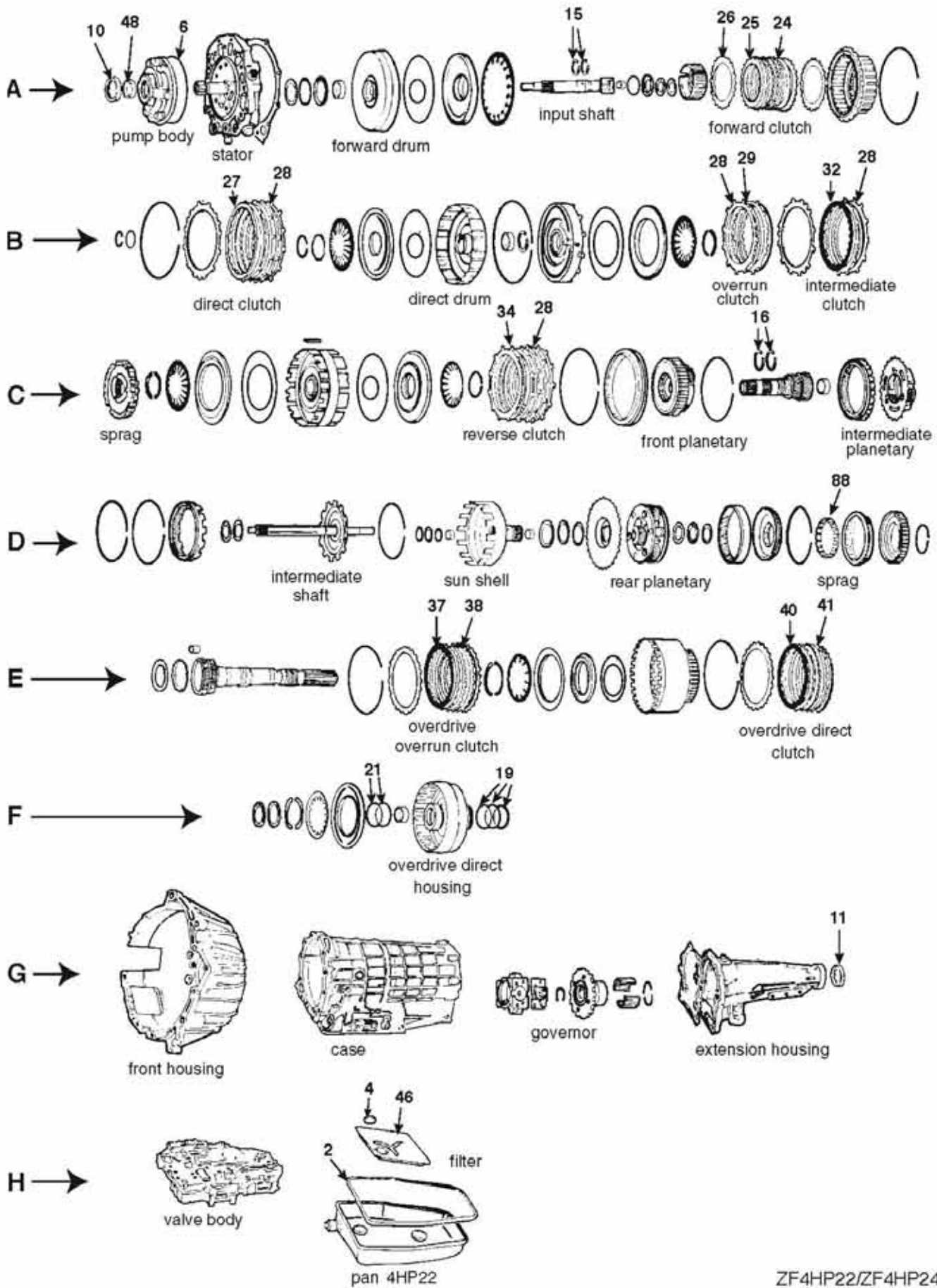

ZF4HP22/ZF4HP24-A
56000D/E/M

ILL	DESCRIPTION	QTY	YEAR	REFERENCE #	PART #
TECHNICAL MANUALS					
K53	Tech manual ZF4HP22 dis/assembly diagnosis/troubleshooting	1	84-04	83-ZF4HP22TM	010-420
REBUILDER KITS					
K5	Master kit w/steels 4HP22	1	84-02	AE	K5600D
K5	Master kit w/steels 4HP24	1	88-04	AE	K5600E
K5	Master kit w/steels Audi Quattro 4HP24A	1	89-94	AE	K5600M
K6	Master kit w/o steels 4HP22	1	84-02	AE	K5600D-LS
K6	Master kit w/o steels BMW V12 850 series 4HP24	1	88-04	AE	K5600E-LS
K6	Master kit w/o steels Audi Quattro 4HP24A	1	89-94	AE	K5600M-LS
K7	O/H gasket set w/seals-rings 4HP22/24	1	84-04	AE	K56900D
K7	O/H gasket set w/seals-rings 4HP24A	1	84-94	AE	K56900M
note	not in kits valve body gaskets for Volvo 740/760 fix add extra holes in gaskets				
VALVE BODY KITS					
K15	Shift Correction Package 4HP22 (forward clutch repair)	1	84-04	K4HP22	K56908A
GASKETS AND RUBBER COMPONENTS					
H2	Gasket, oil pan (molded rubber) 4HP22/24	1	84-04	24-11-1-215-488	13630R
A6	O'ring 4HP22/24 (pump)	1	84-04	24-31-1-217-133	23059
H4	O'ring 4HP22/24 (filter to valve body)	1	84-04	24-31-1-218-570	23076
METAL CLAD SEALS					
A10	Seal, metal clad 40x52x7mm 4HP22 (front)	1	84-04	24-31-1-207-621	56200D
G11	Seal, metal clad 4HP22/24 (extension housing)	1	84-04	24-11-1-207-426	56201B
G11	Seal, metal clad (w/o boot) Lincoln 4HP22 (extension housing)	1	84-85	E2ZZ-7052-A	27695
n/i	Seal, metal clad 22/4HP22 (manual lever shaft)	1	84-04	24-34-1-207-430	56202
SEALING RINGS					
K10	Kit, sealing ring-complete ZF4HP22/24	1	84-04	AE	K56300D
A15	Sealing ring ZF4HP22 (input shaft)	2	84-04	24-21-1-216-345	56303
C16	Sealing ring ZF4HP22 (sun gear shaft)	2	84-04	24-21-1-216-358	56304
n/i	Sealing ring 4HP22 (2nd gear planetary)	1	84-04	24-24-1-217-184	56306
F19	Sealing ring (viton rubber) 4HP22 (governor)	3	84-04	24-23-4-217-141	56305
F21	Sealing ring overdrive direct drum	2	84-04	24-23-1-217-140	56302
n/i	Sealing ring ZF4HP22 (direct clutch B drum)	1	84-04	24-23-1-215-840	56301
CLUTCH PLATES					
A24	Friction .061" 3.931" od 34T ZF4HP22 (forward clutch)	4/5	84-04	1043-202-183	56103A
A24	Friction .061" 5.042" od 40T ZF4HP24 (forward clutch)	4/5	84-04	1043-202-189	56104
A25	Steel .071" 3.000" id 24T ZF4HP22 (forward clutch)	5/6	84-04	1043-302-046	56100
A25	Steel .083" 4.213" id 24T ZF4HP24 (forward clutch)	4/6	84-04	24-23-1-215-453	56101B
A25	Steel .060" 3.000" id 24T ZF4HP22 (forward clutch)	sel	84-04	1043-302-128	56100B
A25	Steel .047" 3.000" id 24T ZF4HP22 (forward clutch)	sel	84-04	1043-302-123	56100C
A26	Steel .040" 3.000" id 24T (waved) ZF4HP22 (forward clutch)	2	84-04	1043-302-001	56105
A26	Steel .055" 4.213" id 24T (waved) ZF4HP24 (forward clutch)	2	84-04	1043-330-140	56105A
B27	Friction .059" 5.629" od 24T ZF4HP24 (direct clutch)	4/5	84-04	1043-202-041	56102A
B28	Steel .071" 4.728" id 12T Ford/Volvo/Peugeot (direct clutch)	3/4	84-04	0301-302-037	56101
B28	Steel .082" 4.690" id 12T BMW/Rover/Jaguar (direct clutch)	4	84-04	1043-302-021	56101F
B28	Steel .047" 4.690" id 12T ZF4HP22(direct clutch)	sel	84-04	0301-317-013	56101C
B28	Steel .047" 4.690" id 12T (waved) ZF4HP22 (direct clutch)	sel	84-04	1043-302-036	56101D
B28	Steel .158" 120mm 12T ZF4HP22 (direct clutch)	sel	84-04	24-23-1-217-334	56101G
B29	Friction .059" 5.629" od 24T ZF4HP22 (intermediate clutch)	2	84-04	1043-202-041	56102A
B29	Friction .063" 5.625" od 48T ZF4HP24 (intermediate clutch)	5	84-04	1043-217-009	56106A
B28	Steel .071" 4.728" id 12T ZF4HP22/24 (intermediate clutch)	3/4	84-04	24-23-1-205-935	56101
B32	Friction .063" 5.625" od 48T 4HP22 (overrun clutch)	4/5	84-04	1043-217-009	56106A
B32	Friction .061" 5.629" od 58T 4HP24 (overrun clutch)	4/5	84-04	1043-217-015	56102B
B28	Steel .047" 4.690" id 12T ZF4HP22 (overrun clutch)	sel	84-04	0301-317-013	56101C
B28	Steel .047" 4.690" id 12T (waved) ZF4HP22 (overrun clutch)	sel	84-04	1043-302-036	56101D
B28	Steel .060" 4.690" id 12T ZF4HP22 (overrun clutch)	sel	84-04	1043-302-020	56101E

ZF4HP22•ZF4HP24-A

ZF4HP22•24-A

ILL	DESCRIPTION	QTY	YEAR	REFERENCE #	PART #	
CLUTCH PLATES (CONTINUED)						
B28	Steel .158" 120mm 12T	ZF4HP22 (overrun clutch)	sel	84-04	2423-1-217-334	56101G
B28	Steel .082" 4.690" id 12T	ZF4HP24 (overrun clutch)	sel	84-04	24-23-1-209-825	56101F
C34	Friction .063" 5.625" od 48T	ZF4HP22 (reverse clutch)	4/5	84-04	24-23-1-205-955	56106A
C34	Friction .061" 5.629" od 58T	ZF4HP24 (reverse clutch)	5/6	84-04	1043-217-015	56102B
C28	Steel .047" 4.690" id 12T	ZF4HP24 (reverse clutch)	6	84-04	1043-317-040	56101H
C28	Steel .059" 4.690" id 12T	ZF4HP24 (reverse clutch)	ar	84-04	1043-317-061	56101J
C28	Steel .071" 4.690" id 12T	ZF4HP24 (reverse clutch)	ar	84-04	1043-317-062	56101K
C28	Steel .083" 4.690" id 12T	ZF4HP24 (reverse clutch)	ar	87-04	1043-317-063	56101L
E37	Friction .061" 5.042" od 40T	4HP22/24 (overdrive overrun clutch)	4	84-04	24-23-1-215-441	56106B
E38	Steel .059" 5.629" od 24T	4HP22/24 (overdrive overrun clutch)	4	84-04	24-23-1-215-440	56101A
E40	Friction .061" 5.042" od 40T	4HP22/24 (overdrive direct clutch)	4	84-04	24-23-1-215-441	56106B
E41	Steel .083" 4.213" id 24T	4HP24 (overdrive direct clutch)	4	84-04	24-23-1-215-453	56101B
n/i	Friction .062" 4.680" od 18T	4HP24A (transfer case)	6	89-94	n/a	56109
n/i	Steel .082" 2.444" id 12T	4HP24A (transfer case)	6	89-94	n/a	56121
n/i	Steel .082" (holes in teeth)	4HP24A (transfer case bottom)	1	89-94	n/a	56123
FILTERS						
K9	Kit, filter	BMW/Lincoln ZF4HP22	1	84-92	AE	FK56800B
K9	Kit, filter	Range Rover ZF4HP22	1	88-04	AE	FK56800C
H46	Filter	BMW/Lincoln ZF4HP22	1	84-92	24-31-1-218-550	56800B
H46	Filter	Range Rover ZF4HP22	1	88-02	1043-226-037	56800C
H46	Filter (w/1" tube)	BMW ZF4HP24	1	89-04	24-31-1-218-204	56800E
H46	Filter	Porsche 911 tipronic	1	91-98	943-307-011-01	56800D
H46	Filter	Audi Quattro ZF4HP24A	1	89-94	1043-226-035	56800M
BUSHINGS						
A48	Bushing .750" (bronze)	4HP22/24 (pump body) lg 2500cc	1	94-04	0501-311-812	56005A
n/i	Bushing	Lincoln 4HP22 (extension housing)	1	84-86	D7FZ-7A034-A	16001A
PUMP PARTS AND PUMPS						
A	Body, pump w/gears	ZF4HP22 (bushing in body)	1	84-04	AE	56300A-R
A	Body, pump w/gears	ZF4HP22 (caged bearing in body)	1	84-04	AE	56300B-R
A	Support, pump w/shaft	ZF4HP22 (casting #103)	1	84-04	AE	56400A-R
A	Support, pump w/shaft	ZF4HP22 (casting #133)	1	84-04	AE	56400B-R
A	Support, pump w/shaft	ZF4HP22 (casting #158)	1	84-04	AE	56400C-R
A	Support, pump w/shaft	ZF4HP22 (casting #258)	1	84-04	AE	56400D-R
A	Support, pump w/shaft	ZF4HP22 (casting #205)	1	84-04	AE	56400E-R
A	Support, pump w/shaft	ZF4HP22 (casting #253)	1	84-04	AE	56400F-R
A	Support, pump w/shaft	ZF4HP22 (casting #255)	1	84-04	AE	56400G-R
A	Support, pump w/shaft	ZF4HP22 (casting #205)	1	84-04	AE	56400H-R
HARD PARTS						
n/i	Valve body	ZF4HP22	1	84-04	AE	56485-R
ELECTRICAL COMPONENTS						
n/i	Kit, solenoid master	4HP22	1	84-04	MS-ZFHP22	25A-040
n/i	Solenoid	4HP22 (shift)	1	84-04	501307869	5A-460
n/i	Solenoid	4HP22 (pressure control)	1	84-04	501206997	5A-461
SPRAGS						
D88	Sprag, overdrive	ZF4HP22/24	1	84-04	24-23-1-215-337	56502
n/i	Sprag, low	ZFHP22/24 (staked in low planetary)	1	84-04	24-23-1-215-338	56503
NOTES						

ENGINE CONVERSION CHART

CU. IN.	LITRE	CYL.	CU. IN.	LITRE	CYL.	CU. IN.	LITRE	CYL.
61	1.0L	3	204	3.3L	L6	350	5.7L	V8
67	1.1L	4	207	3.4L	V6	351	5.8L	V8
73	1.2L	4	215	3.5L	L6	352	5.8L	V8
85	1.4L	4	221	3.6L	V6	354	5.8L	V8
92	1.5L	4	223	3.7L	L6	359	5.9L	V8
96	1.5L	4	225	3.7L	L6	360	5.9L	6/V8
97	1.6L	4	229	3.8L	V6	361	5.9L	V8
98	1.6L	4	230	3.8L	V6	366	6.0L	V8
104	1.7L	4	231	3.8L	V6	368	6.0L	V8
105	1.7L	4	232	3.8L	V6	370	6.1L	V8
107	1.8L	4	239	3.9L	6/V6	379	6.2L	V8
109	1.8L	4	240	3.9L	L6	381	6.2L	V8
110	1.8L	4	241	4.0L	V8	383	6.3L	V8
112	1.8L	4	242	4.0L	L6	389	6.4L	V8
116	1.9L	4	243	4.0L	L6	390	6.4L	V8
119	1.9L	4	245	4.0L	V6	391	6.4L	V8
121	2.0L	4	250	4.1L	6/V6	392	6.4L	V8
122	2.0L	4	252	4.1L	L6	394	6.5L	V8
126	2.1L	4	255	4.2L	V8	396	6.5L	V8
132	2.2L	4	256	4.2L	V8	400	6.6L	V8
133	2.2L	4	258	4.2L	L6	401	6.6L	V8
134	2.2L	4	260	4.3L	V6/V8	402	6.6L	V8
135	2.2L	4	262	4.3L	6/V8	403	6.6L	V8
138	2.3L	4	265	4.3L	V8	406	6.7L	V8
140	2.3L	4	267	4.4L	V8	408	6.7L	V8
144	2.4L	L6	270	4.4L	V6	410	6.7L	V8
146	2.4L	L6	273	4.5L	V8	413	6.8L	V8
150	2.5L	4	280	4.6L	V8	420	6.9L	V8
151	2.5L	4	283	4.6L	V8	421	6.9L	V8
153	2.5L	4	289	4.7L	V8	425	7.0L	V8
156	2.6L	4	292	4.8L	L6	426	7.0L	V8
159	2.6L	4	300	4.9L	6/V8	427	7.0L	V8
170	2.8L	L6	301	4.9L	V8	428	7.0L	V8
171	2.8L	V6	302	5.0L	V8	429	7.0L	V8
173	2.8L	V6	304	5.0L	V8	430	7.0L	V8
177	2.9L	L6	305	5.0L	V8	432	7.1L	V8
179	2.9L	V6	307	5.0L	V8	440	7.2L	V8
181	3.0L	V6	312	5.1L	V8	446	7.3L	V8
183	3.0L	L6	318	5.2L	V8	454	7.4L	V8
189	3.1L	L6	326	5.3L	V8	455	7.5L	V8
190	3.1L	L6	327	5.3L	V8	460	7.5L	V8
194	3.2L	L6	330	5.4L	V8	472	7.7L	V8
195	3.2L	V6	331	5.4L	V8	475	7.8L	V8
196	3.2L	V6	332	5.4L	V8	477	7.8L	V8
198	3.2L	L6	340	5.6L	V8	500	8.2L	V8
200	3.3L	6/V6	341	5.6L	V8			
201	3.3L	L6	348	5.7L	V8			

NOTE: For any engine not listed above, use the following multipliers for proper conversion:

CC to CU. IN. - Multiply by .061306
 CU. IN. to CC - Multiply by 16.38703
 CU. IN. to LITERS - Multiply by .016395
 LITERS to CU. IN. - Multiply by 61.025

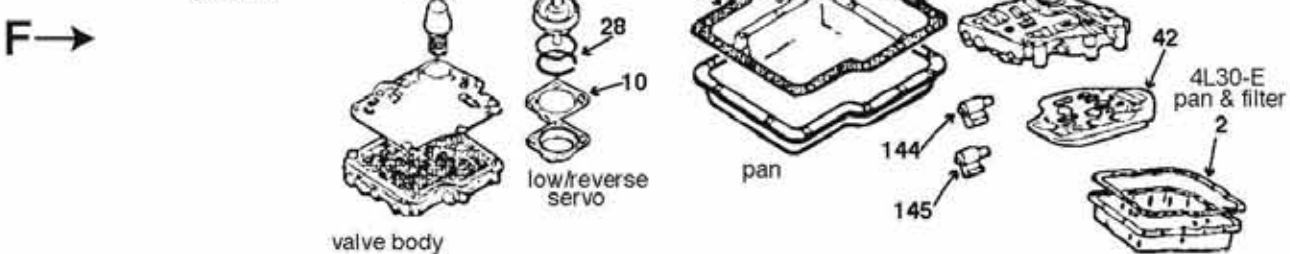
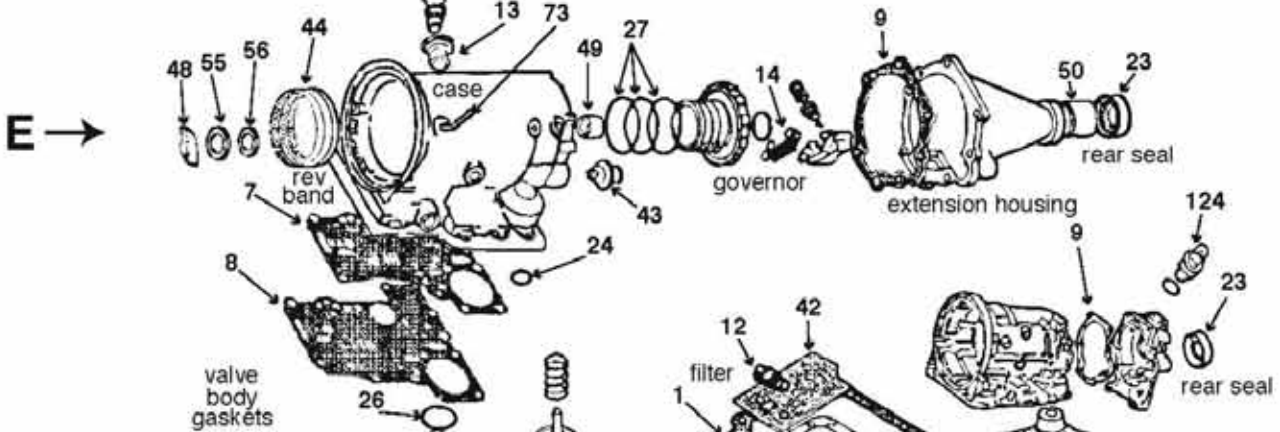
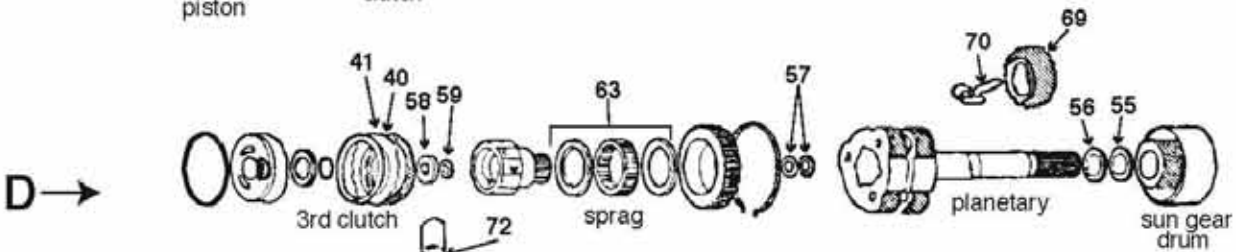
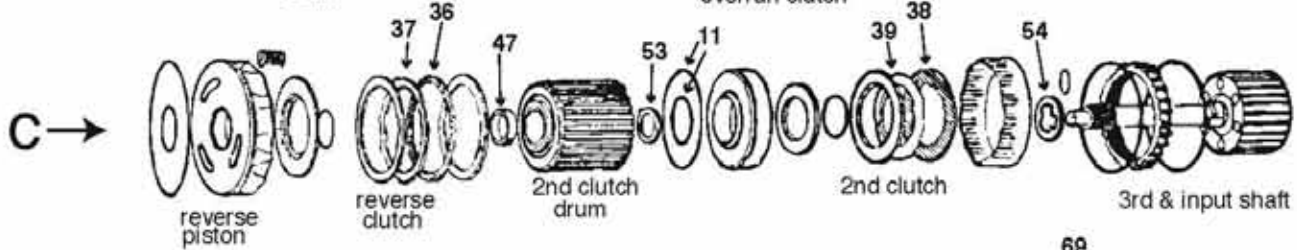
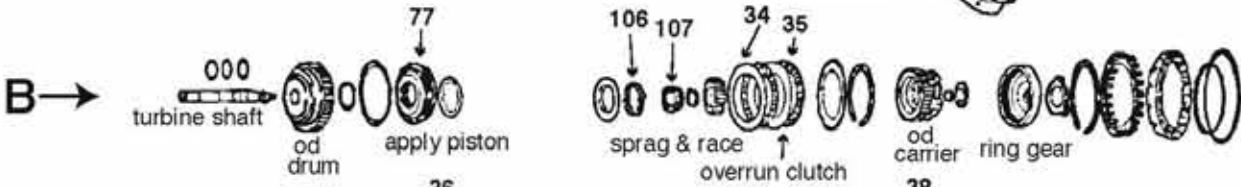
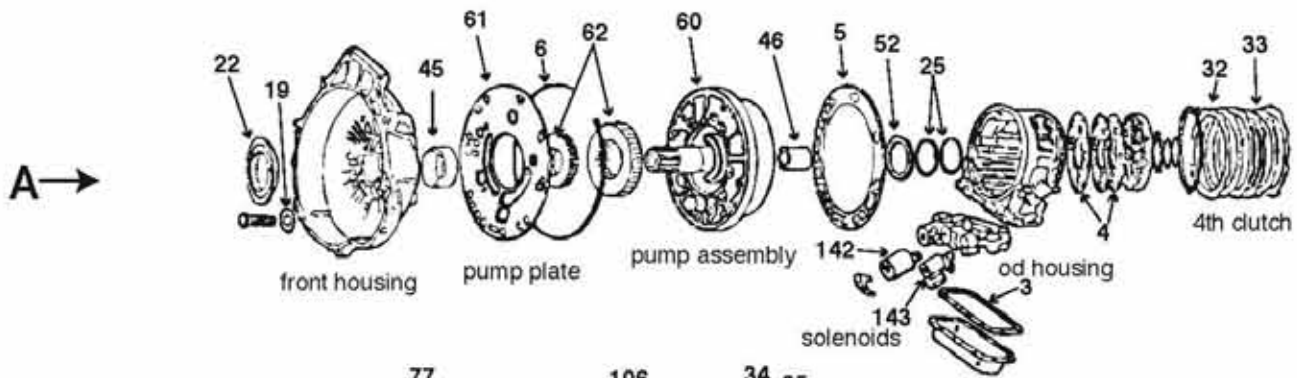

TH180/4L30E
41000/E

TH180 (MD3)•180•TH180C (MD2)•3L30•4L30-E•4L30E

ILL	DESCRIPTION	QTY	YEAR	REFERENCE #	PART #
TECHNICAL MANUALS					
K53	Tech manual 4L30E dis/assembly diagnosis/troubleshooting	1	91-05	83-4L30ETM	10-450
REBUILDER KITS					
K4	Master deluxe rebuild kit TH180/C/3L30 (except Australian)	1	69-98	AE	K4100-R
K5	Master kit w/steels TH180/C/3L30 (except Australian)	1	69-98	AE	K4100
K5	Master kit w/steels 4L30E	1	90-99	AE	K4100E
K5	Master kit w/steels 4L30E	1	98-05	AE	K4100F
K6	Master kit w/o steels TH180/C/3L30 (except Australian)	1	69-98	AE	K4100-LS
K6	Master kit w/o steels 4L30E	1	90-99	AE	K4100E-LS
K6	Master kit w/o steels 4L30E	1	98-05	AE	K4100F-LS
K7	O/H gasket set w/seals-rings TH180/C/3L30 (except Australian)	1	69-98	AE	K41900
K7	O/H gasket set w/seals-rings 4L30E	1	90-05	AE	K41900E
K11	Gasket and seal kit TH180/C/3L30/3L30 (except Australian)	1	69-98	AE	K41900-1
VALVE BODY KITS					
K15	Shift Kit@ 4L30E PWM burn-up/low band/slips	1	90-05	SK@ 4L30E	K41908E
K15	Valve body calibration Kit 4L30E fixes 2-3,3-2,coast down/planet failure	1	90-05	TL-4L30	G41908E
GASKETS AND RUBBER COMPONENTS					
F1	Gasket, oil pan TH180/3L30 (neoprene/cork)	1	69-98	14050668	13600X
F1	Gasket, oil pan TH180/3L30 (Duraprene®)	1	69-98	90064106	13600D
F2	Gasket, oil pan BMW 4L30E (neoprene/cork)	1	90-00	241M-218-850	13604X
F2	Gasket, oil pan BMW 4L30E (Duraprene®)	1	90-00	241M-218-850F	13604D
F2	Gasket, oil pan 4L30E (except BMW neoprene/cork)	1	90-05	8-9014-234-0	13605X
F2	Gasket, oil pan 4L30E (except BMW Duraprene®)	1	90-05	8-9014-234-0F	13605D
A3	Gasket, adapter pan 4L30E (all neoprene/cork)	1	90-05	8-9014-235-0	13606X
A3	Gasket, adapter pan 4L30E (all Duraprene®)	1	90-05	8-9014-235-0F	13606D
A4	Gasket, adapter plate 4L30E (overdrive housing)	2	90-91	8-96015-772-0	13608
A4	Gasket, adapter plate 4L30E (overdrive housing)	2	92-05	8-96016-514-0	13608A
A5	Gasket, pump TH180 (to case)	1	69-98	96013211	13601
A5	Gasket, pump 4L30E (to overdrive housing)	1	90-05	8-96014-973-0	13601E
A6	Seal, lathe cut pump/bell outer and overdrive hsg to case	1/2	69-05	5258119	13602
E7	Gasket, valve body TH180 (upper)(except Australian)	1	69-98	5258155	13610
E7	Gasket, valve body (main) 4L30E (upper)(case to spacer plate)	1	90-05	96017202	13611
E8	Gasket, valve body TH180 (lower)(except Australian)	1	69-87	735057	13612
E8	Gasket, valve body TH180 (lower)(except '87 Chevette)	1	87-98	96040728	13612A
E8	Gasket, valve body (main) 4L30E (lower)(spacer plate to main VB)	1	90-05	96015417	13611A
E9	Gasket, extension housing TH180	1	69-98	5258199/	13613
E9	Gasket, extension housing 4L30E	1	90-05	96014417	13613A
F10	Gasket, servo cover TH180	1	69-98	5258339	13614
F10	Gasket, servo cover 4L30E (w/steel core)	1	90-05	96014414	13614A
C11	Lip seal TH180/C/4L30E (2nd clutch piston outer)	1	69-05	5258041	13607
C11	Lip seal TH180/C/4L30E (2nd clutch piston inner)	1	69-05	5258043	13619
F12	Gasket, filter TH180	1	69-98	5258245	13617
E13	Multi lip seal (boot) TH180/C/4L30E (filler tube to case)	1	79-05	1259475	13925
E14	Gasket, governor TH180/C	1	69-98	5259657/5258520	13615A
A19	Washer, coated pump/bell housing bolts	12	69-05	5258938	13268A
n/i	O'ring speedometer housing (ext Tracker/Sidekick)	1	69-05	7430921	3410L
n/i	O'ring Tracker/Sidekick (speedometer housing)	1	89-05	96057733	3411L
n/i	O'ring 4L30E (speed sensor)	1	90-05	96041008	3412L
n/i	O'ring Honda 4L30E (speedo housing)	1	90-02	9921100	3413L
n/i	O'ring TH180 (filler tube to case)	1	69-78	6264902	3291L
n/i	O'ring TH180 (detent cable)	1	69-98	5258404	3667L
n/i	Hose, vacuum (90° elbow) TH180/C (modulator)	1	69-98	C1AZ-7B087-E	13266
n/i	O'ring TH180/C (modulator)	1	69-98	11078101	13769
n/i	O'ring (teflon coated/green) TH180C/4L30E (turbine shaft)	1	82-98	8662686	13766

TH180•C•4L30-E

TH180 (MD3)•180•TH180C (MD2)•3L30•4L30-E•4L30E

TH180•C•4L30-E

ILL	DESCRIPTION	QTY	YEAR	REFERENCE #	PART #
GASKETS AND RUBBER COMPONENTS (CONTINUED)					
n/i	Lip seal	1	69-05	96014296	13605
n/i	Lip seal	1	69-98	5258543	13606
n/i	Lip seal	1	90-05	96014295	13606A
n/i	Seal, lathe cut	1	69-05	96014332	3774L
n/i	Seal, lathe cut	1	69-05	96014331	3775L
n/i	Lip seal w/spring	1	69-05	25519078	3991L
n/i	Lip seal	1	90-94	96014320	13609
n/i	Lip seal	1	95-05	96017561	13609A
n/i	Seal, lathe cut	1	90-05	96014231	3776L
n/i	Gasket, auxiliary VB	1	90-05	96017400	13639
n/i	Gasket, auxiliary VB	1	90-05	96017399	13639A
n/i	Seal, lathe cut	1	90-05	96014062	3777L
n/i	O'ring	1	90-05	96014673	3288L
n/i	O'ring	2	90-05	96014317	3289L
n/i	O'ring	3	90-05	24204409	13710
n/i	O'ring	3	90-05	8634188	23071
n/i	Seal	2	90-05	n/a	13749
METAL CLAD SEALS					
A22	Seal, metal clad	1	69-98	705216	38151A
A22	Seal, metal clad	1	90-05	96015187	41151
E23	Seal, metal clad 1.950" od (not in kit)	1	69-05	235728-3	47201A
E23	Seal, metal clad	1	71-05	n/a	41204
E23	Seal, metal clad 60x38x12mm	1	69-05	1243402	8850B
E23	Seal, metal clad	1	90-05	96014416	56201B
E23	Seal, metal clad (not in kit)	1	92-97	96040762	41204A
E24	Seal, metal clad	1	69-98	8623056	38511
E24	Seal, metal clad	1	90-05	8644709	51202A
n/i	Seal, metal clad	1	89-98	96057735	41206
n/i	Seal, metal clad	1	94-05	97131328	91206
n/i	Seal, metal clad	1	89-98	96054039	75201M
SEALING RINGS					
K10	Kit, sealing ring	1	69-98	AE	K41300
K10	Kit, sealing ring	1	90-05	AE	K41300E
A25	Ring, sealing	2	69-05	5258106	41302
A25	Ring, sealing (teflon)	2	90-05	9617553	41304T
E26	Ring, sealing (cast iron)	1	69-05	8623653	34711
E27	Ring, sealing (not in kit)	3	69-98	5258100	41300A
E27	Ring, sealing	3	69-05	5258837	41300
F28	Ring, sealing	1	69-05	5258159	41303
n/i	Ring, sealing (teflon)(scarf cut)	2	90-05	96015717	41305T
n/i	Ring, sealing (teflon)(solid)	1	90-05	8634598	32326T
n/i	Ring, sealing	1	90-05	5258837	41300
CLUTCH PLATES					
A32	Friction .088" 6.710" od 36T	3	90-05	8-96014-459-0	41106
A33	Steel .083" 5.835" id 6T	4	90-05	8-96014-187-0	41107
B35	Friction .088" 5.090" od 40T	2	90-05	8-96014-195-0	32108
B34	Steel .083" 3.954" id 36T	2	90-05	96014194	32110
C36	Friction .098" 6.405" od 36T	2/5	69-05	5258017	41100
C37	Steel .070" 5.675" id 7T	ar	69-05	5258019	41101
C37	Steel .083" 5.675" id 7T	3/6	69-05	5258957	41101A
C38	Friction .098" 5.229" od 30T	2/5	69-05	5258025	41102
C39	Steel .070" 4.306" id 36T	3/6	69-05	5258057	41103
C39	Steel .080" 4.306" id 36T	3/6	69-05	960401183	41103A

TH180 (MD3)•180•TH180C (MD2)•3L30•4L30-E•4L30E

ILL	DESCRIPTION	QTY	YEAR	REFERENCE #	PART #
CLUTCH PLATES (CONTINUED)					
D40	Friction .098" 3.875" od 12T TH180 (3rd clutch)	2/5	69-98	90064281	41104
D40	Friction .098" 3.875" od 12T 4L30E (3rd clutch)	4	90-97	96014946	41104
D40	Friction .063" 3.875" od 12T (high energy) 4L30E (3rd clutch)	6	98-05	8-96017-371-0	41104A
D41	Steel .070" 2.850" id 30T TH180/C/4L30E (3rd clutch)	ar	69-05	5258086	41105
D41	Steel .080" 2.850" id 30T TH180/C/4L30E (3rd clutch)	3/6	69-05	5258955	41105A
FILTERS					
K9	Kit, filter TH180/C/3L30 (neoprene/cork)	1	69-98	AE	FK41800
K9	Kit, filter TH180/C/3L30 (Duraprene®)	1	69-98	AE	DK41800
K9	Kit, filter Isuzu/Amigo/Rodeo/Trooper II (4L30E)	1	90-05	AE	FK41800E
K9	Kit, filter Isuzu/Amigo/Rodeo/Trooper II (4L30E)	1	90-05	AE	DK41800E
K9	Kit, filter BMW (4L30E neoprene/cork)	1	91-00	AE	FK41800B
K9	Kit, filter BMW (4L30E Duraprene®)	1	91-00	AE	DK41800B
F42	Filter TH180/C/3L30	1	69-98	5258130/	41800
F42	Filter BMW (4L30E)	1	91-00	24-11-1-218-899	41800B
F42	Filter Isuzu/Amigo/Rodeo/Trooper II (4L30E)	1	90-05	8-96041-011-0	41800E
F42	Filter Opel (4L30E 4 cyl.)	1	92-05	n/a	41800C
n/i	Screen, filter TH180/C (governor)	1	69-98	5258383	26712
n/i	Screen, filter 4L30E (low solenoid)	1	90-05	96041012	41713
n/i	Screen, filter 4L30E (lock-up/TCC solenoid)	1	90-05	96014109	66714
MODULATORS					
E43	Modulator TH180/C (blue) Opel/Holden 1969-74/GM1977-80/Fiat	1	69-80	8958947	41820
E43	Modulator (dual)(blue) GM 1979-Up/Holden 1975-Up others	1	75-98	96013028	41820A
E43	Modulator TH180/C (dual)(green) Opel 1975/others 1980-Up	1	80-98	96013169	41820B
E43	Modulator TH180/C (green) 10-11 eda 1.9 Opel 1975/GM 1980-Up various	1	80-98	90064071	41820C
E43	Modulator TH180/C (purple) Geo Tracker/Suzuki	1	89-97	96040434	41820D
BANDS					
E44	Band TH180/C/4L30E (low)	1	69-05	5463805	41700
BUSHINGS					
K13	Kit, bushing TH180	1	69-98	AE	K41901
K13	Kit, bushing 4L30E	1	90-05	AE	K41901E
A45	Bushing (babbitt) TH180/C/4L30E (pump body/bell hsg)	1	69-05	8958661	8005
A46	Bushing TH180/C/4L30E (stator support rear)	1	69-05	8958621	41003
C47	Bushing TH180/C/4L30E (2nd clutch drum)	1	69-05	5258128	41000
E48	Bushing TH180/C/4L30E (input sun gear)	1	69-05	5258075	41009
E49	Bushing TH180/C/4L30E (case)	1	69-05	5258191	41012
E50	Bushing (babbitt) 1.626" od TH180/C/4L30E (extension housing)	1	69-05	6260048	8008A
n/i	Bushing (bronze) TH180/C/4L30E (stator support front)	1	69-05	8628915	32006
WASHERS/BEARINGS/RACES/SHIMS					
K14	Kit, thrust washer TH180/C	1	69-98	AE	K41907
A52	Thrust washer (plastic) .061" (yellow) TH180/C/4L30E (pump)	sel	69-05	5258201	41208
A52	Thrust washer (plastic) .069" (red) TH180/C/4L30E (pump)	sel	69-05	5258202	41208A
A52	Thrust washer (plastic) .077" (black) TH180/C/4L30E (pump)	sel	69-05	5258203	41208B
A52	Thrust washer (plastic) .084" (white) TH180/C/4L30E (pump)	sel	69-05	5258205	41208C
A52	Thrust washer (plastic) .092" (green) TH180/C/4L30E (pump)	sel	69-05	5258206	41208D
A52	Thrust washer (plastic) .100" (blue) TH180/C/4L30E (pump)	sel	69-05	5258207	41208E
C53	Thrust washer (metal) 2nd clutch drum to 3rd clutch drum	1	69-05	5258091	41702
C53	Thrust washer (plastic) 2nd clutch drum to 3rd clutch drum	1	69-05	96040241	41702A
C54	Thrust washer (metal) TH180/C/4L30E (input shaft rear)	1	69-05	5258554	41703
D55	Bearing, thrust TH180 (race to sun gear drum)	2	69-98	5686837	41704
D56	Race TH180 (rear planet to bearing)	2	69-98	90064108	41705
D57	Race TH180 (bearing to rear planetary)	1	69-98	5258555	41706
D57	Bearing, thrust TH180 (race to sun gear)	1	69-98	96040078	41707
D58	Race TH180 (input shaft to bearing)	1	69-98	90064108	41705

TH180•C•4L30-E

TH180 (MD3)•180•TH180C (MD2)•3L30•4L30-E•4L30E

TH180•C•4L30-E

ILL	DESCRIPTION	QTY	YEAR	REFERENCE #	PART #
WASHERS/BEARINGS/RACES/SHIMS (CONTINUED)					
D59	Bearing, thrust	1	69-98	96040078	41707
PUMP PARTS AND PUMPS					
A60	Pump assembly	1	69-81	AE	41424-R
A60	Pump assembly	1	70-79	AE	41424A-R
A60	Pump assembly	1	81-81	AE	41424C-R
A60	Pump assembly (w/lock-up)	1	82-98	AE	41424B-R
A60	Pump assembly	1	90-05	8-96041-018-0	41424E-R
A60	Pump assembly	1	00-05		41424F-R
A61	Plate, wear pump	1	69-80	5258850	41202-R
A61	Plate, wear pump	1	81-81	96013269	41202B
A61	Plate, wear pump	1	77-87	96013212	41202A-R
A61	Plate, wear pump	1	90-05	8-96015-519-0	41202E
A62	Gear set, pump .626" thick	1	69-06	AE	K41201
A62	Gear set, pump .628" thick	1	69-06	AE	K41201A
HARD PARTS					
D69	Gear, speedo drive (7T black)	1	69-98	90064073	41227
D70	Clip, speedo (5/16" thin long)	1	69-98	1373122	35226
E72	Filler tube repair	1	69-00	n/a	96-140A
E73	Vent tube (plastic)	1	79-05	8640496	96-141
B107	Cam (inner race)	1	90-05	8-08634-038-0	32838-R
ELECTRICAL COMPONENTS					
F124	Sensor, speed	1	90-05	8-96014-442-0	16A-204
A142	Solenoid	1	90-05	8-96014-182-0	5A-400
A142	Solenoid	1	90-00	8677314	5A-400C
A143	Solenoid	1	90-99	8-96014-183-0	5A-333
A143	Solenoid (PWM)	1	00-05	8-96078-534-0	5A-392
F144	Solenoid	1	90-05	8-96014-593-0	5A-334
F145	Solenoid	1	90-05	8-96014-224-0	5A-335
n/i	Solenoid	1	82-98	96040316	5A-163
n/i	Connector, electrical (3 terminal square)	1	90-98	8634383	25A-103
n/i	Solenoid (PWM)	1	90-05	96014795	5A-395
n/i	Connector, electrical (4 terminal square)	1	90-05	8662395	25A-104
n/i	Connector, electrical (5 prongs round)	1	90-05	8649507	25A-105A
n/i	Connector, electrical (7 prongs round)	1	00-05	n/a	25A-107A
n/i	Harness, internal wiring (w/bolt-on TCC)	1	91-99	n/a	16A-270
n/i	Harness, internal wiring (w/bolt-on TCC)	1	00-04	8-96018-478-0	16A-273
n/i	Harness, internal wiring (w/push-on TCC)	1	00-05	n/a	16A-276
n/i	Harness, internal wiring (7 prongs)	1	00-04	8-96018-581-0	16A-274
SPRAGS					
D63	Sprag .700" 2.295" od (26 elements)	1	69-05	5258137	61725
B106	Roller clutch	1	90-05	8-08634-049-0	32849
BONDED PISTONS					
B77	Piston, bonded rubber	1	90-05	8-96017-401-0	41530
n/i	Cover, bonded rubber	1	90-05	96017095	41228
NOTES					



Automatic transmission

10 Digit Numbering System

1st/2nd Digit	Vehicle Make
3rd/4th/5th Digit	Transmission Type
6th/7th/8th Digit	Actual Part Number
9th Digit	Year or Design Change
10th Digit	Manufacturer/Vendor

6th/7th/8th Digit	
K4 Master deluxe rebuild kits	100-101
K5 Master kit w/steels	110-119
K6 Master kit w/o steels	120-129
K7 O/H gasket set w/seals-rings	130-139
K8 External seal kits	140-149
K11 Gaskets & seals kits	150-159
K13 Valve body gasket sets	160-167
K28 Accumulator D ring kits	168-169
K15 Valve body kits	170-179
Pan gaskets neoprene/cork	180-189
Pan gaskets Duraprene®	190-199
Pan gaskets molded rubber	200-209
O-rings/D rings	210-245
Lip seals	246-279
Gaskets	280-299
Metal clad seals	300-314
K10 Sealing ring kits	315-319
K10 Sealing ring kits (metal)	320-330
K10 Sealing ring kits (Teflon/plastic)	331-350
Friction (lined disc)	351-374
Steel/waved plates	375-410
Pressure plates	411-434
K9 Filter kits neoprene/cork	435-439
K9 Filter kits Duraprene®	440-444
K9 Filter kits molded rubber	445-449
Filters	450-464
Modulator	465-474
Bands	475-484
K13 Bushing kits	500-505
Bushings	506-540
K14 Thrust washer kits	545-550
K12 Thrust bearing kits	551-555
K14 Shim kits	556-560
Thrust washers	561-620
Thrust bearing races	561-620
Snap rings	621-669
Pump/pump parts	670-710
Hard parts	721-849
Electrical	850-939
Sprags	940-960
Pistons, bonded rubber	961-994
Bonded piston kits	995-999

This is what a typical number looks like, this one is an O/H gasket set w/seals-rings w/pistons (5R110W)

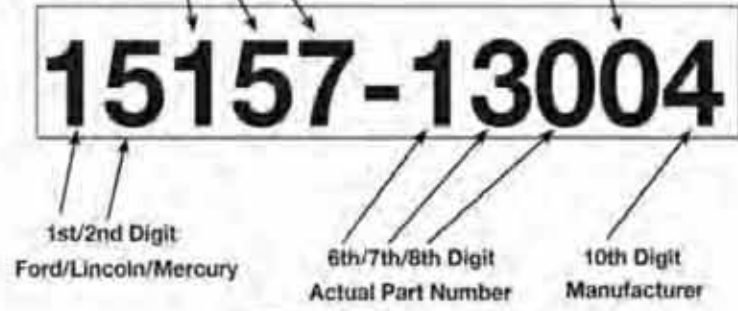
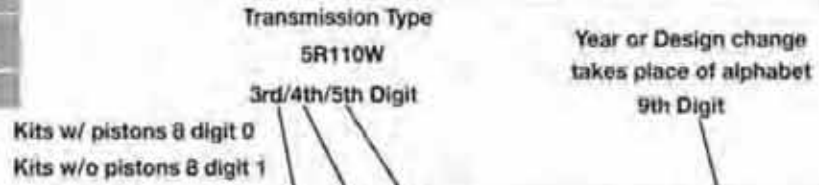

Vehicle Make

10 General Motors	74 Lexus
15 Ford/Lincoln/Mercury	75 Mazda
20 Chrysler/Dodge/Jeep/Eagle	78 Mercedes
25 Acura	80 Mitsubishi
30 Alfa Romeo	82 Nissan/Datsun
40 Audi	83 Opel
45 BMW	84 Peugeot
50 Daewoo	85 Porsche
52 Fiat	86 Renault
55 Daihatsu	87 Saab
56 GEO	90 Saturn
60 Honda	91 Sterling
65 Hyundai	92 Subaru
68 Infiniti	93 Suzuki
70 Isuzu	94 Smart
71 Jaguar	95 Toyota
72 Kia	96 Volkswagen
73 Land Rover	97 Volvo

- 670 Pump assemblies
- 681 Pump gears
- 685 Pump stators
- 675 Pump bodies w/gears

1st/2nd Digit	Vehicle Make	3rd/4th/5th Digit	Transmission Type	6th/7th/8th Digit	Actual Part	9th Digit	Year or Design Change	10th Digit	Manufacturer
0	OEM							0	OEM
1	Borg/Warner							1	Borg/Warner
2	Raybestos							2	Raybestos
3	Rebuilt/Good Used							3	Rebuilt/Good Used
4	Aftermarket							4	Aftermarket
5	Superior							5	Superior
6	SPX							6	SPX
7	Transtec							7	Transtec
8	Hi-Performance							8	Hi-Performance
9	Transgo®							9	Transgo®

10 Digit Numbering System

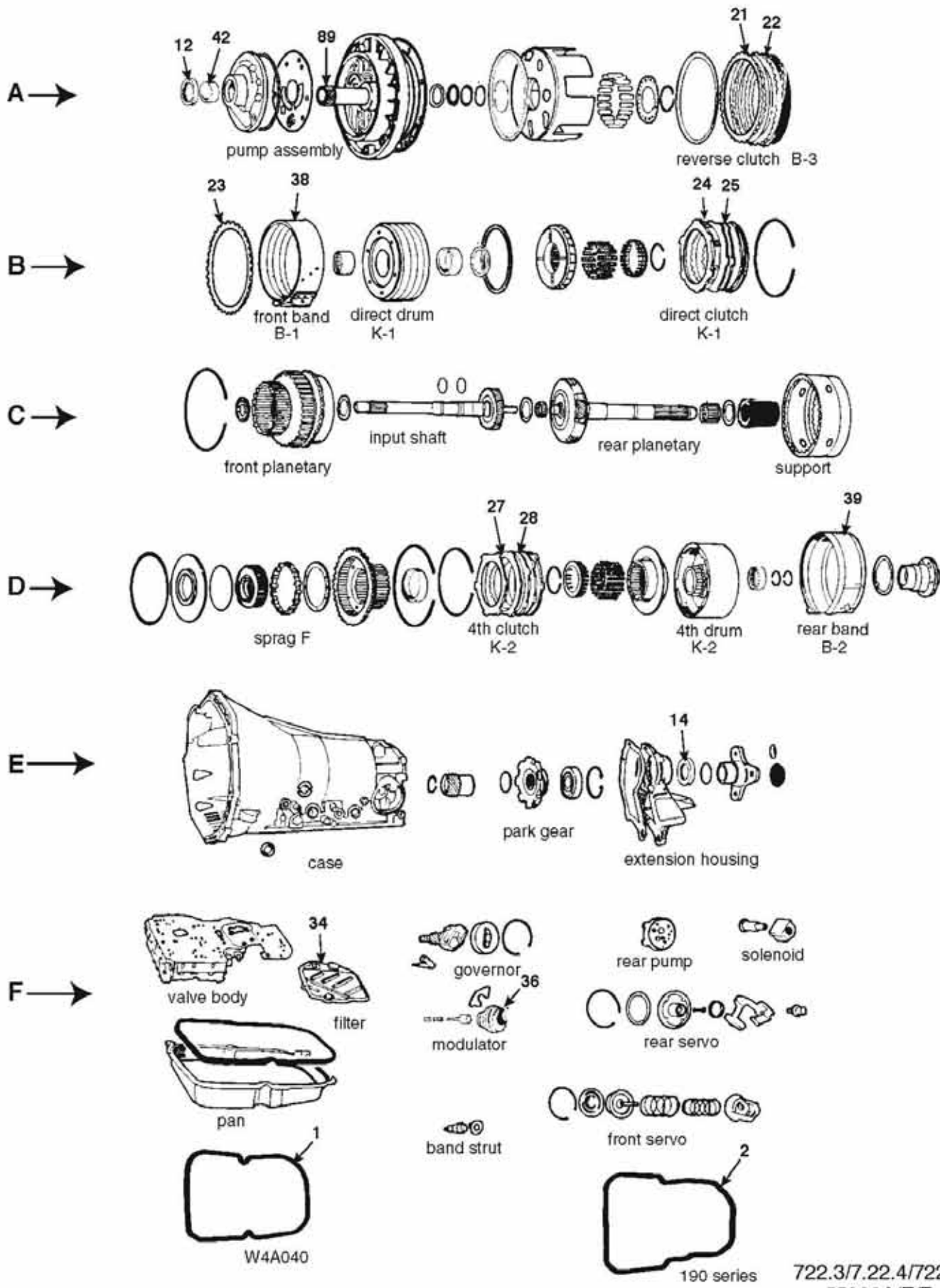

722.3/7.22.4/722.5
55000A/E/F

ILL	DESCRIPTION	QTY	YEAR	REFERENCE #	PART #	
TECHNICAL MANUALS						
K53	Tech manual-covers 722.4 dis/assembly	dis/assembly diagnosis/troubleshooting	1	84-96	83-7224TM	010-422
REBUILDER KITS						
K5	Master kit w/steels-380 series	722.3	1	81-99	AE	K5500A
K5	Master kit w/steels-190 series	722.4	1	84-96	AE	K5500E
K6	Master kit w/o steels-380 series	722.3	1	81-99	AE	K5500A-LS
K6	Master kit w/o steels-190 series	722.4	1	84-96	AE	K5500E-LS
K7	O/H gasket set w/seals-rings-380 Series	722.3	1	81-99	AE	K55900A
K7	O/H gasket set w/seals-rings-190 Series	722.4	1	84-96	AE	K55900E
VALVE BODY KITS						
K15	Shift Correction Package (diesel)	722.3/722.4	1	81-96	K722A-D	K55908D
K15	Shift Correction Package (gas)	722.3/722.4	1	81-96	K722A-G	K55908G
GASKETS AND RUBBER COMPONENTS						
F1	Gasket, molded rubber	722.3	1	81-99	126-271-0280	13841R
F2	O'ring	722.4	1	84-96	201-271-0380	13842
METAL CLAD SEALS						
A12	Seal, metal clad	722.3 (front)	1	81-99	004-997-2847	55206
A12	Seal, metal clad	722.4 (front)(190 series)	1	81-99	010-997-4547	55207
E14	Seal, metal clad	all (extension housing)	1	81-99	008-997-6647	22978
n/i	Seal, metal clad	722.3 (shift shaft)	1	81-99	006-997-0147	55210
n/i	Seal, metal clad	722.4 (shift shaft)(190 series)	1	84-96	008-997-9047	55211
n/i	Seal, metal clad	all (rear servo)	1	81-99	006-997-7347	55212
CLUTCH PLATES						
A21	Friction .081" 6.678" od 36T	722.3 (reverse clutch B-3)	4	81-99	126-272-0925	55104
A21	Friction. 081" 6.016" od 30T	722.4 (reverse clutch B-3)	3/5	84-96	123-272-0325	55107
A22	Steel .091" 5.787" id 36T	722.3 (reverse clutch B-3)	sel	81-99	126-272-6726	55117
A22	Steel .110" 5.787" id 36T	722.3 (reverse clutch B-3)	sel	81-99	126-272-6826	55117A
A22	Steel .130" 5.787" id 36T	722.3 (reverse clutch B-3)	sel	81-99	126-272-6426	55117B
A22	Steel .150" 5.787" id 36T	722.3 (reverse clutch B-3)	sel	81-91	126-272-6526	55117C
A22	Steel .098" 5.060" id 36T	722.4 (reverse clutch B-3)	sel	84-96	201-272-2526	55141
A22	Steel .118" 5.060" id 36T	722.4 (reverse clutch B-3)	sel	84-96	201-272-2126	55141A
A22	Steel .138" 5.060" id 36T	722.4 (reverse clutch B-3)	sel	84-96	201-272-2226	55141B
A22	Steel .158" 5.060" id 36T	722.4 (reverse clutch B-3)	sel	84-96	201-272-2626	55141C
B24	Friction .083" 5.265" od 24T	722.3 (direct clutch K-1)	4/5	81-99	126-272-0625	55103
B24	Friction .083" 4.600" od 40T	722.4 (direct clutch K-1)	3/5	84-96	123-272-0225	55105
B25	Steel .079" 4.094" id 6T	722.3 (direct clutch K-1)	sel	81-99	126-272-0926	55115
B25	Steel .138" 4.094" id 6T	722.3 (direct clutch K-1)	sel	81-99	126-272-1006	55115B
B25	Steel .157" 4.094" id 6T	722.3 (direct clutch K-1)	sel	81-99	126-272-1126	55115C
B25	Steel .177" 4.094" id 6T	722.3 (direct clutch K-1)	sel	81-99	126-272-1226	55115D
B25	Steel .197" 4.094" id 6T	722.3 (direct clutch K-1)	sel	81-96	126-272-1326	55115E
B25	Steel .217" 4.094" id 6T	722.3 (direct clutch K-1)	sel	81-99	126-272-1426	55115F
B25	Steel .079" 3.524" id 6T	722.4 (direct clutch K-1)	sel	84-96	201-272-0726	55128
B25	Steel .118" 3.524" id 6T	722.4 (direct clutch K-1)	sel	84-96	201-272-0826	55128A
B25	Steel .138" 3.524" id 6T	722.4 (direct clutch K-1)	sel	84-96	201-272-0926	55128B
B25	Steel .158" 3.524" id 6T	722.4 (direct clutch K-1)	sel	84-96	201-272-1026	55128C
B25	Steel .178" 3.524" id 6T	722.4 (direct clutch K-1)	sel	84-96	201-272-1126	55128D
D27	Friction .085" 4.870" od 24T	722.3 (4th clutch K-2)	4/5	81-99	126-272-0325	55102
D27	Friction .083" 4.245" od 36T	722.4 (4th clutch K-2)	3/5	84-96	123-272-0125	55106
D28	Steel .079" 3.464" id 6T	722.3 (4th clutch K-2)	1/2	81-99	126-272-0326	55116
D28	Steel .118" 3.464" id 6T	722.3 (4th clutch K-2)	3	81-99	126-272-0426	55116A
D28	Steel .138" 3.464" id 6T	722.3 (4th clutch K-2)	sel	81-99	126-272-0526	55116B
D28	Steel .177" 3.464" id 6T	722.3 (4th clutch K-2)	sel	81-99	126-272-0626	55116D
D28	Steel .197" 3.464" id 6T	722.3 (4th clutch K-2)	sel	81-99	126-272-0726	55116E
D28	Steel .217" 3.464" id 6T	722.3 (4th clutch K-2)	sel	81-99	126-272-0826	55116F

T-1256 Parts List

The Ultimate Engine Hanger



012-128 front leg (2)



012-116 shock tower bracket (2)



012-019 shock tower adapter (2)



012-125 lower front leg bracket (2)



012-109 square poly plug (12)



012-123 front leg rubber pad (2)



012-117 j-hook handle (3)



012-122 front leg handle (2)

all parts are sold separately



012-127 2-link chain (3)



012-120 s-hook (3)



012-111 3 1/2" thread bolt (2)



012-112 2" thread bolt (2)



012-124 thrust bearing (3)



012-110 1/2" flat washer (6)



012-114 1/2" jam nut (2)



012-113 1/2" hex nut (2)



012-106 side cross bar (2)



012-107 cross bar (1)



012-115 bottom bracket w/nut (2)



012-118 j-hook (3)



012-126 top support bracket (9)



012-121 wall hanger (1)



012-108 wall hanger peg (7)

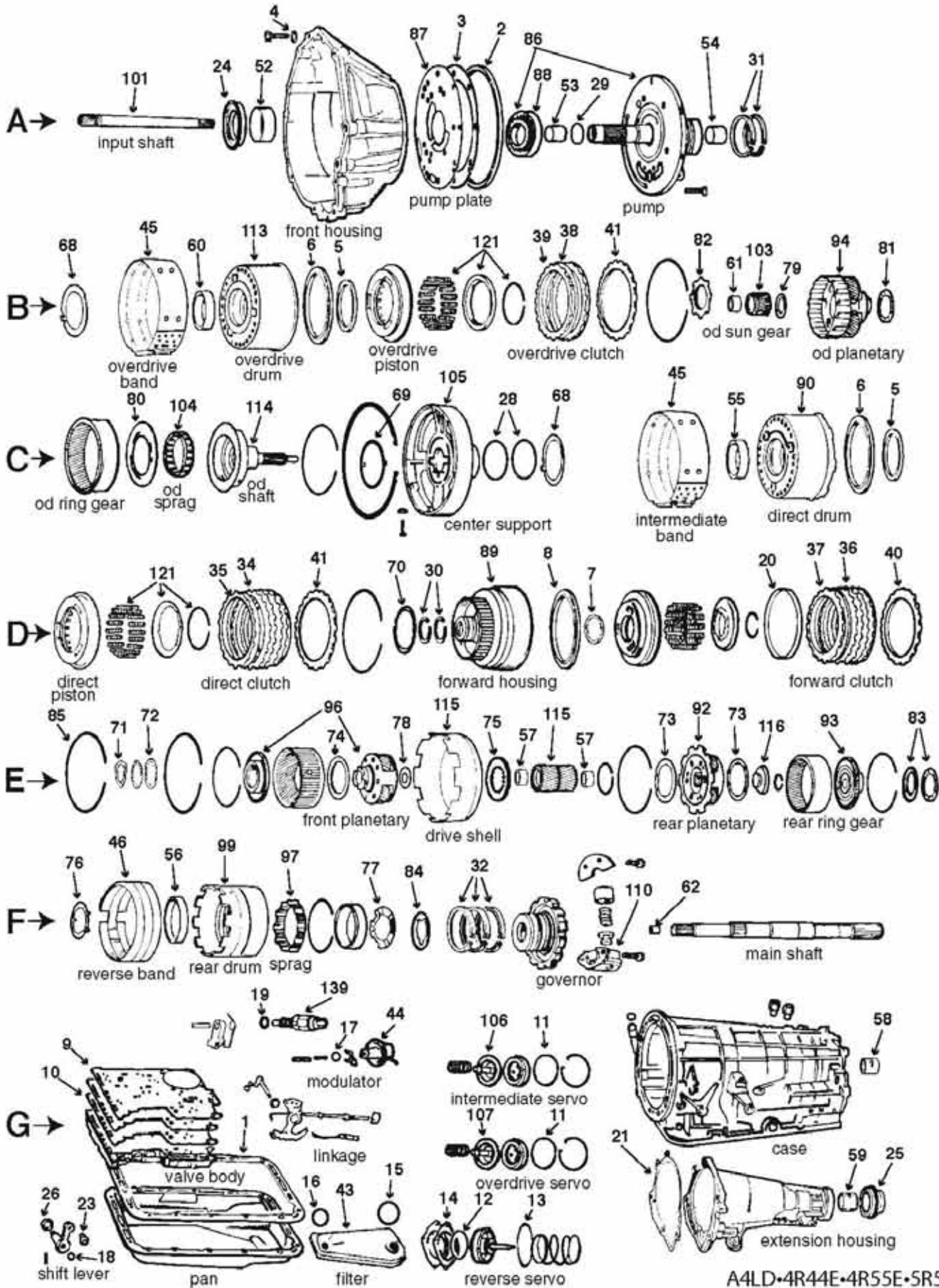

A4LD•4R44E•4R55E•5R55E
27000D/E/G/H

ILL	DESCRIPTION	QTY	YEAR	REFERENCE #	PART #
TECHNICAL MANUALS					
K53	Tech manual Ford A4LD dis/assembly	1	85-95	A4LDTM	010-204
K53	Tech manual 4R44E/4R55E dis/assembly	1	95-01	4R44ETM	010-218
K53	Interchange book changes, parts	1	85-95	A4LDTM-U1	010-219
K53	Tech manual 5R55E dis/assembly	1	97-08	5R55ETM	010-220
REBUILDER KITS					
K4	Master deluxe rebuild kit	1	85-87	AE	K2700D-R
K4	Master deluxe rebuild kit	1	88-89	AE	K2700E-R
K4	Master deluxe rebuild kit	1	90-95	AE	K2700F-R
K4	Master deluxe rebuild kit	1	95-96	AE	K2700G-R
K4	Master deluxe rebuild kit	1	97-08	AE	K2700H-R
K5	Master kit w/steels	1	85-87	AE	K2700D
K5	Master kit w/steels	1	88-89	AE	K2700E
K5	Master kit w/steels	1	90-95	AE	K2700F
K5	Master kit w/steels	1	95-96	AE	K2700G
K5	Master kit w/steels	1	97-08	AE	K2700H
K6	Master kit w/o steels	1	85-87	AE	K2700D-LS
K6	Master kit w/o steels	1	88-89	AE	K2700E-LS
K6	Master kit w/o steels	1	90-95	AE	K2700F-LS
K6	Master kit w/o steels	1	95-96	AE	K2700G-LS
K6	Master kit w/o steels	1	97-08	AE	K2700H-LS
K7	O/H gasket set w/seals-rings	1	88-95	AE	K27900E
K7	O/H gasket set w/seals-rings	1	85-95	AE	K27900F
K7	O/H gasket set w/seals-rings	1	95-96	AE	K27900G
K7	O/H gasket set w/seals-rings	1	97-08	AE	K27900H
K8	External seal kit	1	85-87	AE	K27900D-2
K11	Gasket and seal kit	1	88-89	AE	K27900E-1
K11	Gasket and seal kit	1	85-95	AE	K27900F-1
K11	Gasket and seal kit	1	95-08	AE	K27900G-1
K28	Kit, reverse servo D'ring	1	85-01	AE	K27900-3
VALVE BODY KITS					
K15	Shift Kit@-Jr fixes soft shifts	1	85-95	SK@ A4LD-Jr	K27908E
K15	Shift Kit@	1	95-04	SK@ 44-55E	K27908F
K15	Shift Correction Package	1	85-95	KA4LD	S27908E
K15	Shift Correction Package	1	95-04	K4R-5R55E	S27908F
GASKETS AND RUBBER COMPONENTS					
G1	Gasket, oil pan	1	85-08	E5TZ-7A191-A	13720X
G1	Gasket, oil pan	1	85-08	E5TZ-7A191A	13720D
A2	Seal, lathe cut	1	85-08	D5ZZ-7A248-A	13701
A3	Gasket	1	85-08	D5TZ-7A136-B	13702
A4	Washer	8	85-89	E830124-S	13718
A4	O'ring	8	90-08	E804595-S200	13718A
B5	Seal, lathe cut	1	85-87	D7ZZ-7D404A	13713A
B5	Lip seal	1	88-08	E8TZ-7D404-A	13713
C5	Seal, lathe cut	1	85-87	D7ZZ-7D404-A	13713A
C5	Lip seal	1	88-08	E8TZ-7D404-A	13713
B6	Lip seal	1	88-96	E8TZ-7A548-A	13714
B6	Seal, lathe cut	1	85-87	D7ZZ-7A548-A	13714A
B6	Lip seal	1	97-08	F77Z-7A548-AA	13714C
C6	Lip seal	1	88-96	E8TZ-7A548-A	13714
C6	Seal, lathe cut	1	85-87	D7ZZ-7A548-A	13714A
C6	Lip seal	1	90-08	F0TZ-7A548-A	13714B
D7	Seal, lathe cut	1	85-08	D4ZZ-7A548-B	13711
D8	Seal, lathe cut	1	85-08	D4ZZ-7A548-A	13712

A4LD•4R44E•4R55E•5R55E

A4LD•4R44E•4R55E•5R55E

ILL	DESCRIPTION	QTY	YEAR	REFERENCE #	PART #
GASKETS AND RUBBER COMPONENTS (CONTINUED)					
G9	Gasket, valve body A4LD (upper)	1	85-95	E8RY-7C155-A	13777
G9	Gasket, valve body 4R44E/55E/5R55E (upper)	1	95-08	F5TZ-7C155-A	13777A
G10	Gasket, valve body A4LD (lower)	1	85-95	E8RY-7D100-A	13776
G10	Gasket, valve body 4R44E/55E/5R55E (lower)	1	95-08	F5TZ-7D100-B	13776A
G11	Seal, lathe cut A4LD (overdrive/intermediate servo cover)	2	85-85	D4ZZ-7D040-A	13706
G11	O'ring overdrive/intermediate servo cover	2	86-08	E6TZ-7D040-A	13706A
G12	O'ring A4LD/4R44E/55E/5R55E (reverse servo small)	1	85-08	D4ZZ-7423-B	3435L
F13	O'ring A4LD/4R44E/55E/5R55E (reverse servo large)	1	83-08	D4ZZ-7423-A	13715
G14	Gasket A4LD/4R44E/55E/5R55E (reverse servo cover)	1	85-08	D4ZZ-7L173-A	13708
G15	O'ring A4LD (filter large)	1	85-85	E6TZ-7A469-A	13782
G15	O'ring A4LD/4R44E/55E/5R55E (filter large)	1	86-08	E6TZ-7A469-A	13782A
G16	O'ring A4LD (filter small)	1	85-85	E6TZ-7A469-B	13783
G16	O'ring A4LD/4R44E/55E/5R55E (filter small)	1	86-08	E6TZ-7A469-B	13783A
G17	O'ring A4LD (modulator)	1	85-95	E853110-S	13707
G18	O'ring A4LD (throttle valve lever shaft)	1	85-95	386078-S	3499L
G19	O'ring A4LD (neutral safety switch/MLPS)	1	85-95	E853116-S	13710
D20	Rubber cushion A4LD (forward clutch)	1	85-89	D8ZZ-7B070-A	13740
D20	Rubber cushion A4LD/4R44E/55E/5R55E (forward clutch)	1	90-08	F0TZ-7B070-A	13742
G21	Gasket A4LD (extension housing)	1	85-08	D4ZZ-7086-B	13709
G23	Grommet 5/16" id 1/2" od (not in kit) A4LD/4R44E/55E/5R55E (linkage small)	1	85-08	D5AZ-7341-A	96-126
n/i	O'ring speedo/output speed sensor/case	1	85-08	87036-S94	3410L
n/i	O'ring A4LD/4R44E/55E/5R55E (filler tube to case)	1	85-08	87034-S94	3291L
n/i	Ball, check .250" od (viton) A4LD/4R44E/55E/5R55E (valve body)	5	85-08	E0AZ-7E195-A	13924
n/i	O'ring A4LD (oil cooler tubes)	4	85-08	380892-S94	13327
n/i	Seal, lathe cut (viton) A4LD (governor)	3	85-95	E7TZ-7D011-A	13675
n/i	O'ring A4LD (case connector to case)	2	85-95	84400120	13723
n/i	O'ring 4R44E/4R55E/5R55E (case connector to case)	2	95-08	84400120	13724
n/i	O'ring 4R44/55E (pump gear to converter hub)	1	95-08	W701431-S300	13725
n/i	O'ring 4R44/55E/5R55E (shift solenoid small)	1/4	95-08	W702949-S300	23096
n/i	O'ring 4R44/55E/5R55E (shift solenoid large)	1/4	95-08	W702951-S300	23097
METAL CLAD SEALS					
A24	Seal, metal clad A4LD/4R44E (front)	1	85-96	E5TZ-7A248-A	27601B
A24	Seal, metal clad (rubber coated) 4R55E/5R55E (front)	1	97-08	F7TZ-7A248-AA	27601C
G25	Seal, metal clad (w/boot) A4LD/4R44E/55E/5R55E (extension housing)	1	85-08	E2ZZ-7052-A	27695E
G25	Seal, metal clad (w/o boot) A4LD/4R44E/55E/5R55E (extension housing)	1	85-08	D5ZZ-7052-A	27695
G26	Seal, metal clad A4LD/4R44E/55E/5R55E (manual lever shaft)	1	85-08	D5ZZ-7B498-A	6507A
SEALING RINGS					
K10	Kit, sealing ring A4LD	1	85-95	AE	K27901D
K10	Kit, sealing ring 4R44E/4R55E	1	95-96	AE	K27901G
K10	Kit, sealing ring 4R55E/5R55E	1	97-08	AE	K27901H
C28	Ring, sealing .083" (viton) A4LD (center support to direct drum)	2	85-92	E5TZ-7D429-A	13779
C28	Ring, sealing .103" (viton) A4LD/4R44E (center support to direct drum)	2	93-96	F3TZ-7D429-A	13779A
C28	Ring, sealing (plastic) center support to direct drum	2	97-08	n/a	27228A
A29	Ring, sealing (teflon/scarf cut) A4LD (pump stator/lock up/TCC)	1	85-95	E5TZ-7L323-A	27230T
A29	Ring, sealing (teflon/butt cut) 4R44E/55E/5R55E (pump stator/lock up/TCC)	1	95-08	IL2Z-7L323-AA	27230AT
D30	Ring, sealing (metal) A4LD/4R44E (forward clutch housing)	2	85-96	D4ZZ-7D019-A	27227
D30	Ring, sealing (brass) 4R44E/55E/5R55E (forward clutch housing)	2	97-08	n/a	27227A
A31	Ring, sealing (teflon) A4LD/4R44E (overdrive clutch drum)	2	85-96	E5TZ-7D025-A	27229T
A31	Ring, sealing (plastic) 4R44E/55E/5R55E (overdrive clutch drum)	2	97-08	n/a	27228A
F32	Ring, sealing (seal plated) A4LD (governor)	3	85-95	F0TZ-7D011-A	27645

ILL	DESCRIPTION	QTY	YEAR	REFERENCE #	PART #	
CLUTCH PLATES						
D34	Friction .075" 4.891" od 48T	A4LD (direct clutch)	5	85-89	E3ZZ-7B164-B	27304
D34	Friction 1.75mm .069" 4.891" od 48T	A4LD/4R44E (direct clutch)	6	90-96	F0TZ-7B164-B	27304B
D34	Friction .069" 4.891" od 48T (directional)	direct clutch (helical groove)	6	97-08	F7ZZ-7B-164-BA	27304D
D35	Steel .068" 3.969" id 20T	A4LD (direct clutch)	5	85-89	D8ZZ-7B442-B	27305A
D35	Steel .065" 3.969" id 20T	A4LD/4R44E (direct clutch)	6	90-96	F0TZ-7B442-B	27305B
D35	Steel .082" 3.969" id 20T	4R44E/55E/5R55E (direct clutch)	4/6	97-08	F7ZZ-7B442-AA	27305C
D35	Steel .100" 3.969" id 20T (oversized)	A4LD/4R44E/55E/5R55E (direct clutch)	ar	85-08	D4ZZ-7B442-BOS	27305X
D36	Friction .075" 4.652" od 72T	A4LD (forward clutch)	5	85-89	E3ZZ-7B164-A	27404
D36	Friction .069" 4.652" od 72T	A4LD/4R44E (forward clutch)	6	90-96	F0TZ-7B164-A	27404B
D36	Friction .069" 4.652" od 72T (directional)	forward clutch (helical groove)	6	97-08	F7ZZ-7B164-AA	27404D
D37	Steel .068" 3.801" id 19T	A4LD (forward clutch)	5	85-89	D8ZZ-7B442-A	27505A
D37	Steel .065" 3.801" id 19T	A4LD/4R44E/55E/5R55E (forward clutch)	6	90-08	F0TZ-7B442-A	27505B
D37	Steel .100" 3.801" id 19T (oversized)	A4LD/4R44E/55E/5R55E (forward clutch)	ar	85-08	D4ZZ-7B442-AOS	27505X
C38	Friction .078" 4.891" od 32T (narrow)	A4LD (overdrive clutch)	2/3	85-89	E5TZ-7B164-A	27504
C38	Friction .069" 4.891" od 16T (wide)	A4LD/4R44E (overdrive clutch)	3	90-96	F0TZ-7B164-C	27504C
C38	Friction .069" 4.891" od 16T (directional)	4R44E/55E/5R55E (overdrive clutch)	3	97-08	F7ZZ-7B164-CA	27504D
C39	Steel .068" 3.969" id 20T	A4LD (overdrive clutch)	2/3	85-89	D8ZZ-7B442-B	27305A
C39	Steel .065" 3.969" id 20T	A4LD/4R44E/55E/5R55E (overdrive clutch)	3	90-08	F0TZ-7B442-B	27305B
PRESSURE PLATES						
D40	Pressure plate .202" 19T	A4LD (forward clutch)	1	85-89	D4ZZ-7B066-A	27307-R
D40	Pressure plate .222" 19T	A4LD/4R44E/55E/5R55E (forward clutch)	1	90-08	F0TZ-7B066-A	27307D-R
B41	Pressure plate .202" 20T	A4LD (overdrive clutch)	1	85-89	D4ZZ-7B066-B	27307A-R
B41	Pressure plate .199" 20T	A4LD/4R44E/55E/5R55E (overdrive clutch)	1	90-08	F0TZ-7B066-B	27307B-R
D41	Pressure plate .202" 20T	A4LD (direct clutch)	1	85-89	D4ZZ-7B066-B	27307A-R
D41	Pressure plate .199" 20T	A4LD/4R44E/55E/5R55E (direct clutch)	1	90-08	F0TZ-7B066-B	27307B-R
FILTERS						
K9	Kit, filter (4WD)	A4LD (neoprene/cork)	1	85-85	AE	FK27800D
K9	Kit, filter (4WD)	A4LD (Duraprene®)	1	85-85	AE	DK27800D
K9	Kit, filter (2WD)	A4LD (neoprene/cork)	1	85-85	AE	FK27800E
K9	Kit, filter (2WD)	A4LD (Duraprene®)	1	85-85	AE	DK27800E
K9	Kit, filter (2WD)	A4LD (neoprene/cork)	1	85-88	AE	FK27800G
K9	Kit, filter (2WD)	A4LD (Duraprene®)	1	85-88	AE	DK27800G
K9	Kit, filter (4WD)	A4LD/4R44E/55E/5R55E (neoprene/cork)	1	85-08	AE	FK27800F
K9	Kit, filter (4WD)	A4LD/4R44E/55E/5R55E (Duraprene®)	1	85-08	AE	DK27800F
K9	Kit, filter (2WD)	A4LD/4R44E/55E/5R55E (neoprene/cork)	1	89-08	AE	FK27800H
K9	Kit, filter (2WD)	A4LD/4R44E/55E/5R55E (Duraprene®)	1	89-08	AE	DK27800H
G43	Filter (2WD)	A4LD	1	85-85	E5TZ-7A098-B	27800E
G43	Filter (4WD)	A4LD	1	85-85	E5TZ-7A098-A	27800D
G43	Filter (2WD)	A4LD	1	85-88	E6TZ-7A098-B	27800G
G43	Filter (4WD)	A4LD/4R44E/55E/5R55E	1	85-08	E6TZ-7A098-A	27800F
G43	Filter (2WD)	A4LD/4R44E/55E/5R55E	1	89-08	E9TZ-7A098-C	27800H
n/i	Screen, filter	lock-up/TCC solenoid	1	85-08	E8TZ-7N113-AA	27712
MODULATORS						
G44	Modulator	A4LD	1	85-95	E5TZ-7A377-BC	27830G
G44	Modulator (w/Modojust, will retro)	to allow adj w/heat shield thumb wheel	1	90-95	F0TZ-7A377-A	27830H
G44	Modulator (turbo)(olive)	A4LD	1	85-95		27830E
BANDS						
B45	Band, flex	A4LD/4R44E/55E/5R55E (overdrive)	1	85-08	E6TZ-7D034-A	27320F
B45	Band, flex (triple wrap)	A4LD/4R44E/55E/5R55E (overdrive 4.0L only)	1	90-08	F0TZ-7F196-A	27320E
C45	Band, flex	A4LD/4R44E/55E/5R55E (intermediate)	1	85-08	E6TZ-7D034-A	27320F
F46	Band, rigid	A4LD/4R44E/55E/5R55E (reverse)	1	85-06	E3ZZ-7D095-A	27520A
n/i	Nut, band adjusting (w/seal)	A4LD/4R44E/55E/5R55E	2	85-08	380850-S	26610

A4LD•4R44E•4R55E•5R55E

A4LD•4R44E•4R55E•5R55E

ILL	DESCRIPTION	QTY	YEAR	REFERENCE #	PART #	
BUSHINGS						
K13	Kit, bushing	A4LD/4R44E	1	85-96	AE	K27905D
A52	Bushing (bronze)	A4LD/4R44E/55E/5R55E (bell/pump housing)	1	85-08	n/a	27001A
A52	Bushing (babbitt)	A4LD/4R44E/55E/5R55E (bell/pump housing)	1	85-08	n/a	27001B
A52	Bushing (seal-sure)	A4LD/4R44E/55E/5R55E (bell/pump housing)	1	85-08	n/a	27001X
A53	Bushing	A4LD (pump/stator front)	1	85-87	n/a	27000
A53	Bushing	A4LD/4R44E/55E/5R55E (pump/stator front)	1	88-08	n/a	27009
A54	Bushing	A4LD/4R44E/55E/5R55E (pump/stator rear)	1	85-08	n/a	27000A
C55	Bushing	A4LD/4R44E (direct drum cast iron only)	1	85-96	90DT-7D046-AA	27002
C55	Bushing (bronze)	A4LD/4R44E (direct drum)	1	85-96	84GT-7L671-AA	27002B
F56	Bushing	A4LD/4R44E (reverse/rear drum except 4.0L)	1	85-96		27004
E57	Bushing	A4LD/4R44E (rear sun gear front and rear)	2	85-96	74DT-7D065-A	27003
G58	Bushing	A4LD/4R44E (case)	1	85-96		27005
G59	Bushing	A4LD/4R44E/55E/5R55E (extension housing)	1	85-08	74DT-7A034-AA	16001A
B60	Bushing (bronze)	A4LD/4R44E (overdrive drum)	1	85-96		27002B
B61	Bushing	A4LD/4R44E/55E/5R55E (overdrive sun gear)	1	85-08	94GT-7D065-BA	27000
F62	Bushing (bronze)	A4LD (output shaft pilot)	1	85-89		27006
F62	Bushing, caged	A4LD/4R44E/55E/5R55E (output shaft pilot)	1	90-08		27006B
WASHERS/BEARINGS/RACES/SHIMS						
K14	Kit, thrust washer (w/o selectives)	A4LD/4R44E (except below)	1	85-96	AE	K27907D
K14	Kit, thrust washer	4.0L (w/o bearings or selectives)	1	90-96	AE	K27907E
K14	Kit, thrust washer	4R44E/4R55E (w/o selectives/w/o lube dam)	1	97-01	AE	K27907G
F62	Bearing, caged	A4LD/4R44E/55E/5R55E (output shaft pilot)	1	90-08	n/a	27006B
B68	Thrust washer (metal) .055"	A4LD (pump to overdrive drum)	sel	85-08	E5TZ-7D014-A	27209A
B68	Thrust washer (plastic) .063" (#2)	A4LD/4R44E/55E (pump to overdrive drum)	sel	85-08	E5TZ-7D014-B	27209B
B68	Thrust washer (plastic) .078" (#3)	A4LD/4R44E/55E (pump to overdrive drum)	sel	85-08	E5TZ-7D014-C	27209C
B68	Thrust washer (plastic) .094" (#4)	A4LD/4R44E/55E (pump to overdrive drum)	sel	85-08	E5TZ-7D014-D	27209D
B68	Thrust washer (plastic) .109" (#5)	A4LD/4R44E/55E (pump to overdrive drum)	sel	85-08	E5TZ-7D014-E	27209E
C68	Thrust washer (metal) .055"	A4LD (center support direct drum)	sel	85-95	E5TZ-7D014-A	27209A
C68	Thrust washer (plastic) .063" (#2)	A4LD/4R44E/55E (center supt direct drum)	sel	85-96	E5TZ-7D014-B	27209B
C68	Thrust washer (plastic) .078" (#3)	A4LD/4R44E/55E (center supt direct drum)	sel	85-96	E5TZ-7D014-C	27209C
C68	Thrust washer (plastic) .094" (#4)	A4LD/4R44E/55E (center supt direct drum)	sel	85-96	E5TZ-7D014-D	27209D
C68	Thrust washer (plastic) .109" (#5)	A4LD/4R44E/55E (center supt direct drum)	sel	85-96	E5TZ-7D014-E	27209E
C68	Bearing, thrust .105"	A4LD/4R44E/55E (center support rear)	sel	93-96	F3TZ-7L326-A	27233
C68	Bearing, thrust .120"	4R44E/55E (center support rear)	sel	95-96	F5TZ-7L326-A	27233A
C68	Bearing, thrust .125"	4R44E/55E (center support rear)	sel	95-96	F5TZ-7L326-B	27233B
C68	Bearing, thrust .130"	4R44E/55E (center support rear)	sel	95-96	F5TZ-7L326-C	27233C
C68	Bearing, thrust	4R44E/55E (center support rear)	1	97-08	F7TZ-7D014-VA	27231
C69	Thrust washer 2.594" id 3" od	A4LD/4R44E (center support front)	1	85-96	E5TZ-7L326-A	27217
C69	Bearing, thrust .105"	od sft to center sup frt w/snap type shell	1	93-96	F3TZ-7L326-A	27233
C69	Bearing, thrust	overdrive shaft to center support	1	97-08	F77Z-7M153-EB	27226
D70	Thrust washer	fwd hsg to center sup w/o snap type shell	1	85-96	E5TZ-7C096-A	27210D
D70	Bearing, thrust	fwd hsg to center sup w/snap type shell	1	93-95	F3TZ-7C096-A	27225
D70	Bearing, thrust	center support frt to fwd hsg direct drum	1	97-08	F77Z-7M153-EB	27226
E71	Thrust washer (3 tabs)	forward housing to forward planetary	1	85-89	D4ZZ-7D090-A	27211A
E71	Bearing, thrust	fwd hsg to fwd hub w/6 pinion planetary	1	90-95	F3TZ-7D234-A	27235
E72	Thrust washer (4 tabs)	A4LD (forward hub to snap ring)	1	85-89	D4ZZ-7D090-B	27211
E72	Thrust washer (cup type)	forward ring gear hub w/4 pinion planetary	1	87-90	E7TZ-7A045-A	27011
E72	Thrust washer (cup type)	fwd ring gear hub w/6 pinion planetary	1	90-08	F0TZ-7D090-A	27011A
E73	Thrust washer (6 tabs outer)	drive shell to rear planetary aluminum	2	85-89	D4ZZ-7A166-A	27213
E73	Thrust washer (3 tabs outer)	drive shell to rear planetary steel	1	89-96	F0TZ-7A166-A	27213B
E73	Thrust washer (3 tabs outer)	rear planetary to rear hub steel	1	89-96	F0TZ-7A166-B	27213A
E73	Bearing, thrust	drive shell to rear planetary	1	97-08	F7ZZ-7M151-BA	27232
E73	Bearing, thrust	rear planetary to rear hub	1	97-08	F77Z-7M153-EB	27226

ILL	DESCRIPTION	QTY	YEAR	REFERENCE #	PART #
WASHERS/BEARINGS/RACES/SHIMS (CONTINUED)					
E74	Bearing, thrust forward hub to forward planetary	1	89-08	E1FZ-7F374-A	57407
E74	Thrust washer (6 tabs outer) A4LD (forward hub to forward planetary)	1	85-89	D4ZZ-7A166-A	27213
E75	Thrust washer (metal) 27T internal A4LD (drive shell to thrust washer)	1	85-96	D4ZZ-7D066-A	27215
F76	Thrust washer A4LD (rear hub to rear sprag inner race)	1	85-89	D4ZZ-7D422-B	27218
F76	Thrust washer rear hub to rear sprag inner race (4.0L)	1	90-96	F0TZ-7D422-A	27218B
F77	Thrust washer (not in kit) rear sprag inner race to case (4.0L)	1	90-08	n/a	27224
E78	Race, thrust bearing fwd planetary brg open face to sun gear	1	85-95	E5TZ-7D235-A	27219-R
B79	Race, thrust bearing od planetary brg open face to sun gear	1	85-96	E5TZ-7D235-B	27220-R
C80	Thrust washer 4.078" od A4LD (overdrive overrunning clutch)	1	85-92	E5TZ-7L339-A	27221
B81	Bearing, thrust (flat/open faced) od carrier to od hub w/shaft	1	85-08	E5TZ-7L495-A	27222
B82	Washer overdrive drum to overdrive sun gear	1	85-08	E5TZ-7660-A	27223
E83	Race rear hub to rear inner sprag race	1	97-08	F7ZZ-7M150-DA	27218C
E83	Bearing, thrust rear hub to rear inner sprag race	1	97-08	F7ZZ-7M150-CA	27218D
F84	Thrust washer A4LD/4R44E/55/5R55E (case to park gear)	1	85-08	D4ZZ-7B368-A	27216
SNAP RINGS					
E85	Snap ring .096" A4LD/4R44E/55E/5R55E (forward clutch)	1	85-08	E860115-S	27510C
PUMP PARTS AND PUMPS					
A86	Support, pump assembly 8mm bolts no plate	1	85-87	E5TZ-7A103-A	27200D
A86	Support, pump assembly 8mm bolts no plate	1	85-87	E5TZ-7A103-A	27200D-R
A86	Support, pump assembly 10mm bolts no plate	1	88-95	E8TZ-7A103-A	27200E
A86	Support, pump assembly 10mm bolts no plate	1	88-95	E8TZ-7A103-A	27200E-R
A86	Support, pump w/o bearings 4R44E/4R55E	1	95-96	XL2Z-7A103-BA	27200G
A86	Support, pump w/o bearings 4R44E/4R55E	1	95-96	XL2Z-7A103-BA	27200G-R
A86	Support, pump w/bearings 4R44E/4R55E/5R55E	1	97-08	F77Z-7A103-CA	27200H
A86	Support, pump w/bearings 4R44E/4R55E/5R55E	1	97-08	F77Z-7A103-CA	27200H-R
A87	Plate, pump w/8mm bolt holes A4LD	1	85-87	E5TZ-7B472-B	27202D
A87	Plate, pump w/10mm bolt holes A4LD	1	88-95	F0TZ-7B472-A	27202E
A87	Plate, pump 4R44E/4R55E/5R55E	1	95-08	F5TZ-7B472-A	27202G
A87	Plate, pump 4R44E/4R55E/5R55E	1	95-08	F5TZ-7B472-A	27202G-R
A88	Gear set A4LD/4R44E/4R55E	1	85-95	74DT-7L201	K27201
A88	Gear set 4R44E/4R55E/5R55E	1	95-08	AE	K27201A
HARD PARTS					
D89	Drum, forward (6 clutch) A4LD	1	90-96	F0TZ-7A360-A	27400B-R
D89	Drum, forward (5 clutch) A4LD	1	85-96	F0TZ-7A360-B	27400C-R
D89	Drum, forward (5 clutch) 4R44E/55E/5R55E	1	97-08	F77Z-7A360-DD	27400D-R
D89	Drum, forward (6 clutch) 4R44E/55E/5R55E	1	97-08	F77Z-7A360-EE	27400E-R
C90	Drum, direct (4 clutch stamped steel) A4LD	1	85-89	E5TZ-7D044-F	27300C-R
C90	Drum, direct (5 clutch stamped steel) A4LD	1	85-89	E5TZ-7D044-E	27300G
C90	Drum, direct (5 clutch stamped steel) A4LD	1	85-89	E5TZ-7D044-E	27300G-R
C90	Drum, direct (6 clutch cast iron) A4LD (snap type drive shell)	1	90-95	F0TZ-7D044-C	27300F
C90	Drum, direct (6 clutch cast iron) A4LD (snap type drive shell)	1	90-95	F0TZ-7D044-C	27300F-R
C90	Drum, direct (4 clutch cast iron) A4LD/4R44E (snap type drive shell)	1	90-96	n/a	27300Q-R
C90	Drum, direct (4 clutch cast iron) A4LD (non snap type drive shell)	1	90-94	F0TZ-7D044-A	27300D-R
C90	Drum, direct (5 clutch cast iron) A4LD (non snap type drive shell)	1	90-95	F0TZ-7D044-B	27300E-R
C90	Drum, direct (6 clutch cast iron) A4LD/4R44E	1	90-96	n/a	27300P-R
C90	Drum, direct (4 clutch) A4LD/4R44E	1	95-96	F5TZ-7D044-C	27300H-R
C90	Drum, direct (5 clutch) A4LD/4R44E	1	95-96	F5TZ-7D044-D	27300J-R
C90	Drum, direct (4 clutch) 4R44E/55E	1	97-01	F77Z-7D044-AA	27300K-R
C90	Drum, direct (5 clutch) 4R44E/55E	1	97-01	XL2Z-7D044-CA	27300L-R
C90	Drum, direct 4R44E/55E	1	99-01	F87Z-7D044-AA	27300M-R
C90	Drum, direct 4R44E/55E/5R55E	1	02-08	IL5Z-7D044-BA	27300N-R
E92	Planetary (aluminum) A4LD (rear/reverse)	1	85-87	D4ZZ-7D006-A	27448-R
E92	Planetary (4 pinion steel) A4LD/4R44E (rear/reverse)	1	87-96	E7SZ-7D006-C	27448A-R

A4LD•4R44E•4R55E•5R55E

A4LD•4R44E•4R55E•5R55E

ILL	DESCRIPTION	QTY	YEAR	REFERENCE #	PART #	
HARD PARTS (CONTINUED)						
E92	Planetary (6 pinion steel)	A4LD/4R44E (rear/reverse 4.0L)	1	90-96	F0TZ-7D006-A	27448B-R
E92	Planetary (4 pinion steel)	4R44E/55E/5R55E (rear/reverse)	1	97-08	XL2Z-7D006-BA	27448C-R
E92	Planetary (6 pinion steel)	4R44E/55E/5R55E (rear/reverse)	1	97-08	XL2Z-7D006-AA	27448D-R
E93	Hub, rear	A4LD (output)	1	85-91	D4ZZ-7A153-A	27427-R
E93	Hub, rear	A4LD/4R44E (output)	1	87-96	E7SZ-7D164-A	27427A-R
E93	Hub, rear	A4LD/4R44E (output 4.0L)	1	90-96	F0TZ-7D164-C	27427B
E93	Hub, rear	A4LD/4R44E (output 4.0L)	1	90-96	F0TZ-7D164-C	27427B-R
E93	Hub, rear	4R44E/55E/5R55E (output)	1	97-08	F77Z-7D164-AD	27427C-R
C94	Planetary, overdrive	A4LD	1	85-94	E5TZ-7B446-A	27413D
C94	Planetary, overdrive	A4LD	1	85-94	E5TZ-7B446-A	27413D-R
C94	Planetary, overdrive (w/reluctor ring)	4R44E/55E/5R55E	1	95-08	XL2Z-7B446-AB	27413E
E96	Planetary (3 pinion aluminum)	w/ring gear hub (forward)	1	85-87	D4ZZ-7A398-A	27412-R
E96	Planetary (6 pinion steel w/ring gear hub)	A4LD (forward)	1	90-08	E7TZ-7A398-A	27412A-R
F99	Drum, reverse	A4LD (except 4.0L)	1	85-96	D4ZZ-7C498-A	27560-R
F99	Drum, reverse (w/sprag)	A4LD (4.0L)	1	90-96	F0TZ-7C498-A	27560A
F99	Drum, reverse (w/sprag)	A4LD (4.0L)	1	90-96	F0TZ-7C498-A	27560A-R
F99	Drum, reverse (w/sprag)	4R44E/4R55E	1	97-08	XL2Z-7C498-BA	27560B
F99	Drum, reverse (w/sprag)	5R44E/5R55E	1	97-08	XL2Z-7C498-AA	27560C
A101	Shaft	A4LD/4R44E/4R55E/5R55E	1	85-08	F0TZ-7017-D	27411D-R
B103	Gear, sun 24T	A4LD/4R44E/4R55E/5R55E (overdrive)	1	85-08	F7RZ-7D063-AA	27728D-R
C105	Support, center	A4LD	1	85-94	E9TZ-7A130-AA	27902D
C105	Support, center	A4LD	1	85-94	E5TZ-7A130-A	27902D-R
C105	Support, center (w/snap type shell)	A4LD	1	90-94	F1TZ-7A130-AA	27902E
C105	Support, center (w/snap type shell)	A4LD	1	90-94	F1TZ-7A130-AA	27902E-R
C105	Support, center	4R44E/4R55E	1	95-96	F5TZ-7A130-B	27902G-R
C105	Support, center	4R44E/55E/5R55E	1	97-08	F77Z-7A130-CB	27902H-R
F110	Governor assembly	A4LD	1	85-95	D8ZZ-7C063-A	27615A-R
B113	Drum, overdrive	A4LD	1	85-89	E9TZ-7L669-A	27420
B113	Drum, overdrive	A4LD	1	85-89	E9TZ-7L669-A	27420-R
B113	Drum, overdrive	A4LD	1	90-94	F0TZ-7L669-A	27420A
B113	Drum, overdrive	4R44E/55E	1	95-96	F5TZ-7L669-A	27420B-R
B113	Drum, overdrive	4R44E/55E/5R55E	1	97-08	XL2Z-7L669-AA	27420C-R
C114	Shaft (hub/outer race)	A4LD (overdrive bushing type output shaft)	1	85-89	E5TZ-7A658-A	27450
C114	Shaft (hub/outer race)	A4LD (overdrive bushing type output shaft)	1	85-89	E5TZ-7A658-A	27450-R
C114	Shaft (hub/outer race)	overdrive bearing type output shaft	1	90-95	F0TZ-7A658-A	27450A
C114	Shaft (hub/outer race)	overdrive bearing type output shaft	1	90-95	F0TZ-7A658-A	27450A-R
C114	Shaft (hub/outer race w/plastic sprag)	overdrive bearing type output shaft	1	92-96	F3TZ-7A658-A	27450B-R
C114	Shaft (hub/outer race w/plastic sprag)	overdrive bearing type output shaft	1	97-08	XL2Z-7A658-AA	27450C-R
E115	Shell, drive (w/sun gear)	A4LD	1	85-90	F0TZ-7D064-A	27728-R
E115	Shell, drive (w/o sun gear snap type)	A4LD	1	90-95	F3TZ-7D064-A	27728A
E115	Shell, drive (w/sun gear snap type)	A4LD	1	90-95	F3TZ-7D064-A	27728A-R
E115	Shell, drive (w/sun gear w/o sensor slots)	4R44E/55E/5R55E	1	97-01	F77Z-7D064-BB	27728B-R
E115	Shell, drive (w/sun gear w/sensor slots)	4R44E/55E/5R55E	1	01-08	IL5Z-7D064-AA	27728C-R
E116	Oil dam (output hub)	A4LD/4R44E/55E/5R55E	1	90-08	F0TZ-7B176-A	27025
D121	Set, retainer w/springs	A4LD/4R44E/55E/5R55E	2	85-08	K56850	K27301
G126	Lever, shift	T-Bird	1	87-93	E7SZ-7A256-A	E7SZ-7A256-A
G126	Lever, shift	Mustang	1	87-93	F3ZZ-7A256-A	E7ZZ-7A256-A
G126	Lever, shift	Merkur	1	88-89	E7RY-7A256-A	E7RY-7A256-A
G126	Lever, shift	Aerostar	1	85-91	E5TZ-7A256-B	E5TZ-7A256-B
G126	Lever, shift	all others	1	85-88	E5TZ-7A256-A	E5TZ-7A256-A
G126	Lever, shift	all others	1	89-95	F3TZ-7A256-A	E9TZ-7A256-B
G126	Lever, shift	Aerostar	1	92-95	F3TZ-7A256-B	F3TZ-7A256-B
n/i	Linkage pin	A4LD/4R44E/55E/5R44E/55E	1	85-08	n/a	096-009

ILL	DESCRIPTION	QTY	YEAR	REFERENCE #	PART #		
HARD PARTS (CONTINUED)							
n/i	Bracket, solenoid		4R44E/55E/5R44E/55E	1	95-08	XL2Z-7L491-AA	27912
ELECTRICAL COMPONENTS							
G139	Switch, neutral safety (4 pins)		A4LD	1	85-90	D6RY-7A247-B	15A-264-R
G139	Switch, neutral safety (5 pins)		A4LD	1	85-95	E6TZ-7A247-A	15A-265-R
n/i	Solenoid		A4LD (lock-up/TCC)	1	85-95	E5TZ-7F037-A	5A-255
n/i	Solenoid		A4LD (3-4 shift)	1	88-95	E8TZ-7M107-A	5A-257
n/i	Solenoid		4R44E/55E/5R55E (coast/shift/SS1/2/3)	1/4	95-08	F77Z-7G484-A	5A-520
n/i	Solenoid (green)		4R44E/55E (force motor/EPC)	1	95-96	F5TZ-7H144-A	5A-521
n/i	Solenoid (red)		4R44E/55E/5R55E (force motor/EPC)	1	97-08	XL2Z-7G383-AA	5A-523
n/i	Solenoid		4R44E/55E (lock-up/TCC)	1	95-96	F5TZ-7F037-AA	5A-530
n/i	Solenoid		4R44E/55E/5R55E (lock-up/TCC)	1	97-01	F77Z-7G136-AA	5A-532
n/i	Sensor		4R44E/55E/5R55E (turbine shaft speed/TSS)	1	95-08	F5TZ-7M101-A	15A-525
n/i	Sensor		5R55E input (middle of case)	1	97-08	XW4Z-7M183-AA	15A-526
n/i	Sensor		4R44E/55E/5R55E (overdrive drum speed/ODS)	1	97-08	n/a	15A-530
n/i	Sensor		4R44E/55E/5R55E (output speed/OSS)	1	97-08	F7RZ-7H103-BA	15A-535
n/i	Solenoid, master kit		A4LD (2 solenoids)	1	85-95	MS-A4LD	25A-025
n/i	Connector w/internal harness (16 pins)		4R44E/55E/5R55E (case)	1	95-08	F5TZ-7Z409-B	25A-139
n/i	Connector (2 prongs)		A4LD (case)	1	85-89	E7TZ-7E449-A	25A-200
n/i	Connector (3 prongs)		A4LD (case)	1	88-95	E7SZ-7E449-A	25A-258
n/i	Solenoid, master kit		A4LD	1	85-88	52-9006	25A-027
n/i	Solenoid, master kit		A4LD	1	88-95	52-9005	25A-026
n/i	Harness, external repair		4R44E/55E	1	95-08	F5TZ-7X409-B	16A-425
n/i	Sensor, manual lever position (MLPS)		4R44E/55E (except Crown Victoria)	1	95-96	F5AZ-7A247-A	05-120
n/i	Sensor, digital transmission range (DTR)		4R44E/55E/5R55E	1	97-08	F7LZ-7F293-AA	05-120A
SPRAGS							
F97	Kit, spring/roller (w/retainer)		A4LD/4R44E (rear except 4.0L)	1	85-96	D4ZZ-7D191-A	K27960
F97	Sprag		A4LD/4R44E (rear 4.0L)	1	90-96	90GT-7F109-BB	27960A
F97	Sprag		4R44E/4R55E (rear)	1	97-08	F77Z-7A089-BB	27960B
F97	Sprag		5R44E/5R55E (rear)	1	97-08	F77Z-7A089-BR	27960C
C104	Sprag		A4LD (overdrive)	1	85-92	E5TZ-7A089-A	27961D
C104	Sprag (plastic)		A4LD/4R44E/55E (overdrive)	1	92-96	n/a	27961E
C104	Sprag		4R44E/4R55E/5R55E (overdrive)	1	97-08	F77Z-7A089-AB	27962
N/I	Tool to install plastic sprag		A4LD/4R44E/55E (overdrive)	1	92-96	n/a	27961T
BONDED PISTONS							
F106	Piston 1.655" (bonded rubber)		intermediate servo (cover FB)	1	90-08	F0TZ-7D021-B	27528C
F106	Piston 1.850" (bonded rubber)		intermediate servo (cover CA/CB)	1	85-08	E3ZZ-7D021-A	27528D
F106	Piston 1.945" (bonded rubber)		intermediate servo (cover BA/BB)	1	86-08	F2ZZ-7D021-A	27528B
F106	Piston 1.710" (bonded rubber)		intermediate servo (cover EB)	1	90-08	F77Z-7D021-EA	27528E
F106	Piston 1.775" (bonded rubber)		intermediate servo (cover DB)	1	90-08	F77Z-7D021-DA	27528A
F106	Piston 2.300" (bonded rubber)		intermediate servo (cover ZC)	1	97-08	F77Z-7D021-ZA	27528F
F107	Piston 2.100" (bonded rubber)		intermediate servo (cover AA/AB)	1	85-08	F77Z-7D021-A2A	27528
NOTES							

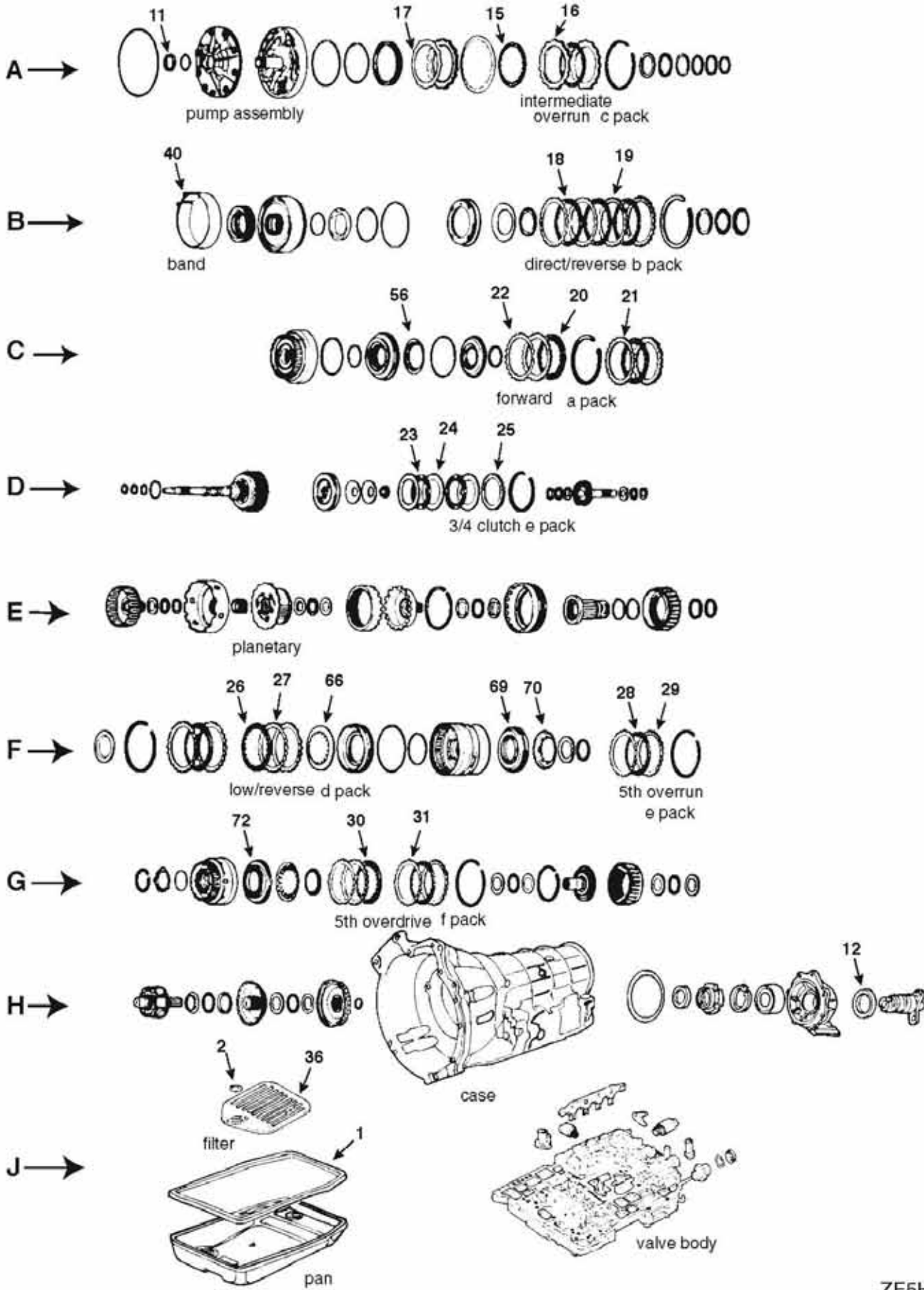

ZF5HP18
56000F

ILL	DESCRIPTION	QTY	YEAR	REFERENCE #	PART #
REBUILDER KITS					
K5	Master kit w/steels w/o pistons	1	93-98	AE	K5600F
K6	Master kit w/o steels w/o pistons	1	93-98	AE	K5600F-LS
K7	O/H gasket set w/seals-rings w/o pistons	1	93-98	AE	K56900F
GASKETS AND RUBBER COMPONENTS					
J1	Gasket, oil pan ZF5HP18	1	93-98	24-11-1-219-127	13660
J2	O'ring filter	1	93-98	0734-313-181	23067
METAL CLAD SEALS					
A11	Seal, metal clad 40x52x7mm front	1	93-98	24-31-1-207-433	56200D
H12	Seal, metal clad 68x52x8mm extension housing	1	93-98	0734-319-404	56203
SEALING RINGS					
K10	Kit, sealing ring ZF5HP18	1	93-98	AE	K56300B
CLUTCH PLATES					
A15	Friction .063" 5.625" od 48T (C) intermediate clutch	3/4	93-98	1043-217-009	56106A
A16	Steel .082" 4.690" id 12T (C) intermediate clutch	3/4	93-98	1043-302-021	56101F
A17	Steel 120mm .118" 12T (apply) (C) intermediate clutch	1	93-98	1043-302-092	56101M
B18	Friction .079" 5.792" od 30T (B) direct/reverse clutch	2/3	93-98	1056-272-024	83103
B19	Steel .071" 5.204" id 24T (B) direct/reverse clutch	2/3	93-98	1050-302-011	83100
C20	Friction .063" 5.778" od 30T (A) forward clutch	4	93-98	1050-217-002	83101
C21	Steel .071" 5.204" id 24T (A) forward clutch	4	93-98	1050-302-011	83100
C22	Steel, waved .040" 5.204" id 24T (A) forward clutch	1	93-98	1050-302-012	83115
D23	Friction .063" 4.250" od 36T (E) 3rd/4th clutch	5	93-98	1050-230-033	83107
D24	Steel .071" 3.079" id 30T (E) 3rd/4th clutch	4/5	93-98	1050-330-017	83104
D25	Steel .138" 3.079" id 30T (E) 3rd/4th clutch	ar	93-98	1056-271-014	83105
F26	Friction .063" 5.778" od 30T (D) low/reverse clutch	5/6	93-98	1050-202-035	83101
F27	Steel .071" 5.204" id 24T (D) low/reverse clutch	5/6	93-98	1050-302-011	83100
F28	Friction .061" 5.778" od 30T (E) 5th overrun clutch	3/4	93-98	1056-277-036	82101
F29	Steel .071" 4.730" id 24T (E) 5th overrun clutch	3/4	93-98	1036-302-015	82100
G30	Friction .061" 5.778" od 30T (F) 5th overdrive clutch	4/5	93-98	1056-277-012	82101
G31	Steel .118" 4.730" id 24T (F) 5th overdrive clutch	5/6	93-98	1056-329-002	82110
FILTERS					
K9	Kit, filter ZF5HP18	1	93-98	AE	FK56800F
J36	Filter, oil ZF5HP18	1	93-98	24-34-1-219-631	56800F
BANDS					
B40	Band, intermediate 1.570" wide	1	93-98	24-23-1-421-346	56700
PUMP PARTS AND PUMPS					
A	Pump assembly ZF5HP18	1	93-98	AE	56200F-R
HARD PARTS					
C56	Spring, diaphragm (A) forward clutch	1	93-98	0501-316-285	56701-R
F66	Spring, diaphragm (D) low/reverse clutch	1	93-98	0501-312-903	56702-R
F70	Spring, diaphragm (E) overrun clutch	1	93-98	0501-312-904	56703-R
n/i	Spring, diaphragm (C) clutch intermediate	1	93-98	1050-331-021	56704-R
n/i	Valve body ZF5HP18	1	93-98	AE	56585-R
BONDED PISTONS					
F69	Piston, bonded rubber (E) clutch	1	93-98	0750-132-057	56501
G72	Piston, bonded rubber (F) clutch	1	93-98	0750-132-060	56504
NOTES					

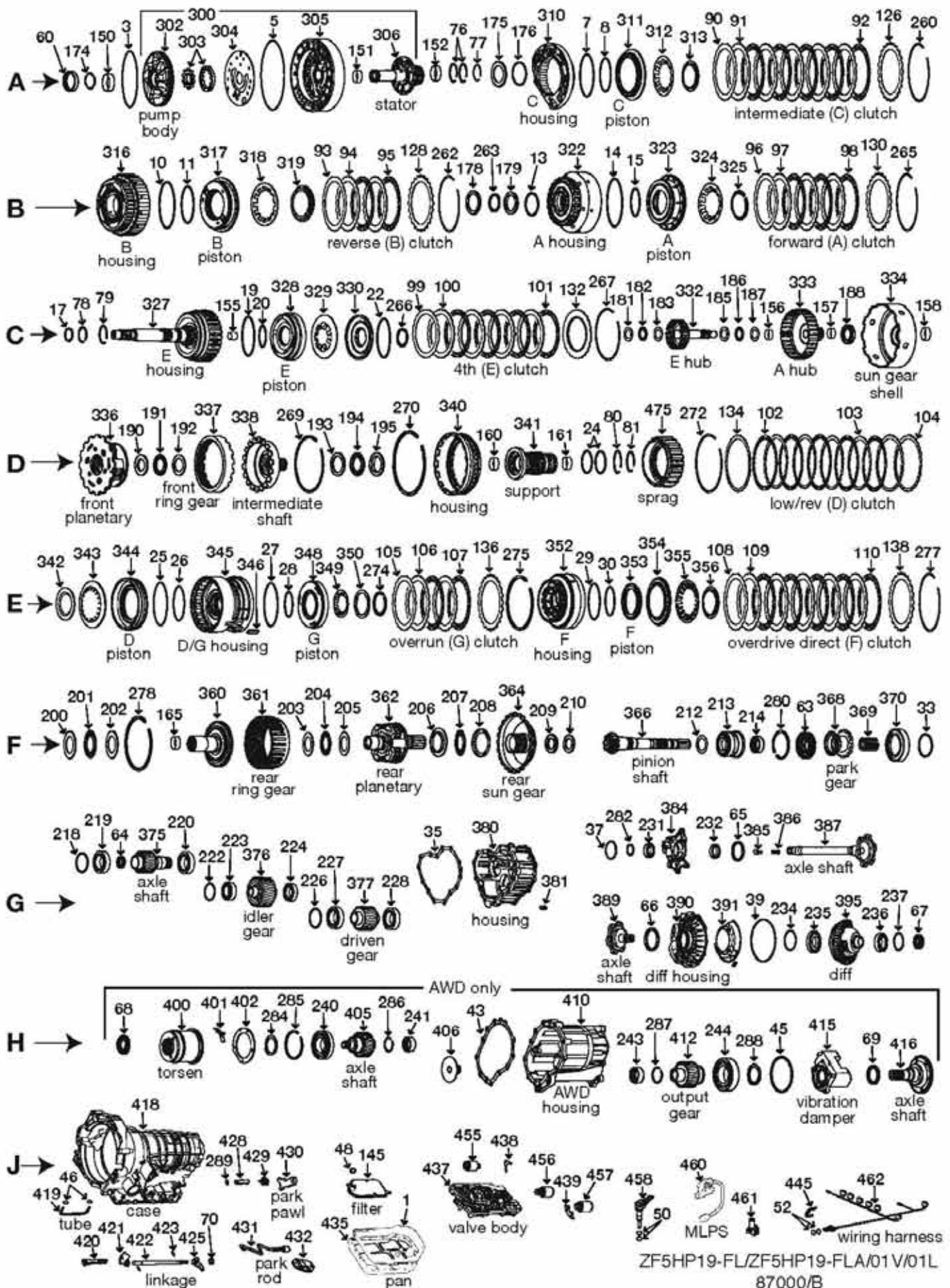

ZF5HP19-FL/ZF5HP19-FLA/01V/01L
87000/B

ILL	DESCRIPTION	QTY	YEAR	REFERENCE #	PART #	
REBUILDER KITS						
K5	Master kit w/steels	5HP19FL (FWD)	1	94-06	AE	K8700
K5	Master kit w/steels	5HP19FLA (AWD)	1	94-06	AE	K8700A
K5	Master kit w/steels	BMW (5HP19 RWD)	1	94-06	AE	K8700B
K6	Master kit w/o steels	FWD	1	94-06	AE	K8700-LS
K6	Master kit w/o steels	AWD	1	94-06	AE	K8700A-LS
K6	Master kit w/o steels	RWD	1	94-06	AE	K8700-LS
K7	O/H gasket set w/seals-rings	All	1	94-06	AE	K87900
GASKETS AND RUBBER COMPONENTS						
J1	Gasket, oil pan	All except BMW	1	94-06	1056-303-031	13662
J1	Gasket, oil pan	BMW	1	96-04	1060-390-002	13663
METAL CLAD SEALS						
A60	Seal, metal clad 40x52x7mm	front	1	94-06	0750-111-254	56200D
G66	Seal, metal clad	intermediate section (large)	1	94-06	0734-319-547	56212
G67	Seal, metal clad	intermediate section (small)	1	94-06	0734-319-604	56207
F64	Seal, metal clad	differential pinion shaft	1	94-06	0734-319-529	56210
G65	Seal, metal clad	differential axle	1	94-06	0750-111-399	56204
G65	Seal, metal clad	extension housing	1	94-06	0734-319-419	56209
H69	Seal, metal clad	extension housing	1	94-06	0750-111-253	56215
H69	Seal, metal clad	extension housing	1	94-06	0734-319-588	56211
G68	Seal, metal clad	extension housing	1	94-06	0734-310-342	56206
J70	Seal, metal clad	shaft shaft (ZF5HP19)	1	94-06	0750-110062	56208
J70	Seal, metal clad	shaft shaft (ZF5HP19FL/FLA)	1	94-06	0734-319-524	56214
SEALING RINGS						
K10	Kit, sealing ring	ZF5HP19FLA	1	94-06	n/a	K87300
CLUTCH PLATES						
A91	Steel .071" 5.740" id 24T	(C) intermediate clutch	4/5	95-04	1060-372-002	87104
A91	Steel .082" 5.740" id 24T	(C) intermediate clutch	sel	95-04	APC-139705-210	87104A
A91	Steel .094" 5.740" id 24T	(C) intermediate clutch	sel	95-04	1060-310-053	87104B
A91	Steel .118" 5.740" id 24T	(C) intermediate clutch	sel	95-04	APC-139705-300	87104C
A92	Friction .061" 6.635" od 40T	(C) intermediate clutch	4/5	55-04	1019-273-019	87103
B94	Steel .071" 5.204" id 24T	(B) reverse clutch	2	95-04	1060-372-002	87106
B95	Friction .079" 6.097" od 30T	(B) reverse clutch	2	95-05	1060-272-003	87105
B97	Steel .071" 5.204" id 24T	(A) forward clutch	4/5	95-04	1050-302-011	83100
B97	Steel, waved .040" 5.204" id 24T	(A) forward clutch	1	95-04	1056-370-009	83115
B98	Friction .063" 5.778" od 30T	(A) forward clutch	4/5	95-05	1050-217-002	83101
C100	Steel .071" 3.079" id 30T	(E) 4th clutch	4/5	95-04	1050-330-017	83104
C101	Friction .063" 4.250" od 36T	(E) 4th clutch	4/5	95-04	1050-230-033	83107
D102	Friction .063" 5.778" od 30T	(D) low/reverse clutch	5/6	95-04	1050-217-002	83101
D103	Steel .071" 5.204" id 24T	(D) low/reverse clutch	5/6	95-04	1050-302-011	83100
E106	Steel .071" 4.730" id 24T	(G) overrun clutch	3/4	95-04	1056-277-036	82100
E107	Friction .061" 5.778" od 30T	(G) overrun clutch	3/5	95-04	1056-277-036	82101
E109	Steel .118" 4.730" id 24T	(F) overdrive direct clutch	5/6	95-04	1056-377-045	82110
E110	Friction .061" 5.778" od 30T	(F) overdrive direct clutch	4/5	95-04	APC-103702-155	82103
PRESSURE PLATES						
A126	Pressure plate .130" 24T	(C) intermediate clutch	sel	95-04	APC-139705-300	87714-R
A126	Pressure plate .153" 24T	(C) intermediate clutch	sel	95-04	1019-373-029	87714A-R
B128	Pressure plate 30T	(B) reverse clutch	1	95-05	1060-372-003	87715-R
B130	Pressure plate .178" 24T	(A) forward clutch	1	95-04	1050-302-013	87716-R
C132	Pressure plate 30T	(E) 4th clutch	1	95-04	1056-371-043	87717-R
D134	Pressure plate .175" 24T	(D) low/reverse clutch	1	95-04	1050-302-013	87719-R
E136	Pressure plate 24T	(G) overrun clutch	1	95-04	1056-377-046	87720-R
E138	Pressure plate	(F) overdrive direct	1	95-05	AE	87721-R

T-1256

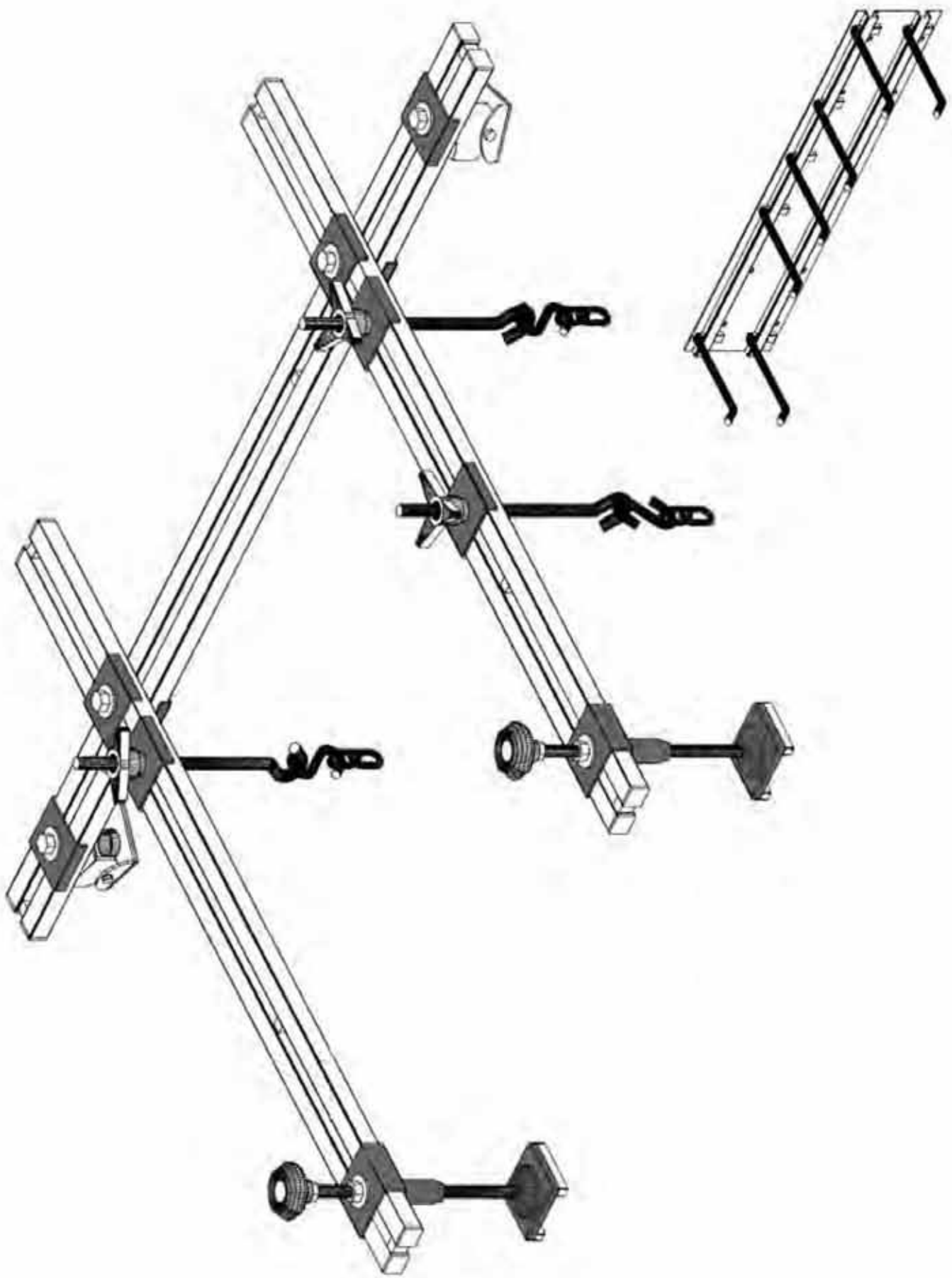

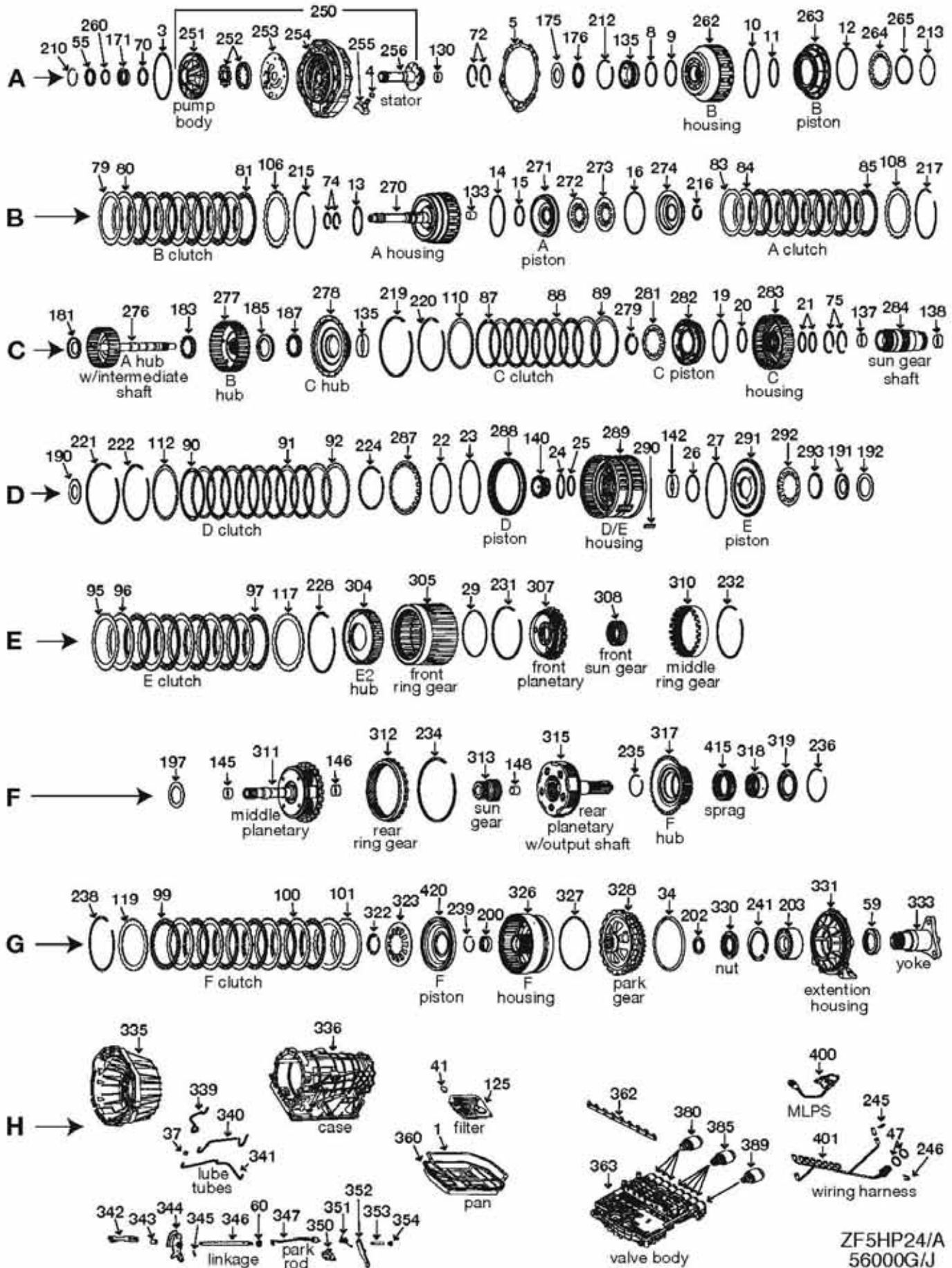

ZF5HP24/A
56000G/J

ILL	DESCRIPTION	QTY	YEAR	REFERENCE #	PART #	
REBUILDER KITS						
K5	Master kit w/steels	5HP24/A/22 w/o piston	1	95-04	AE	K5600G
K5	Master kit w/steels	5HP24/A/22 w/piston	1	95-04	AE	K5600J
K6	Master kit w/o steels	5HP24/A/22 w/o piston	1	95-04	AE	K5600G-LS
K6	Master kit w/o steels	5HP24/A/22 w/piston	1	95-04	AE	K5600J-LS
K7	O/H gasket set w/seals-rings	5HP24/A/22 w/o piston	1	95-04	AE	K56900G
K7	O/H gasket set w/seals-rings	5HP24/A/22 w/piston	1	95-04	AE	K56900J
GASKETS AND RUBBER COMPONENTS						
H1	Gasket, oil pan	RWD	1	95-04	24-11-1-422-676	13665
H1	Gasket, oil pan	AWD	1	95-04	1058-303-015	13670
H41	O'ring	ZF5HP24A	1	95-04	0734-313-181	23067
METAL CLAD SEALS						
A55	Seal, metal clad 40x52x7mm	front	1	95-04	0750-111-254	56200D
G59	Seal, metal clad	BMW/Jaguar (extension housing (2WD)	1	98-03	0750-11-243	56205
G59	Seal, metal clad	left outer extension (4WD)	1	55-04	0734-310-342	56206
G59	Seal, metal clad	right inner extension (4WD)	1	95-04	0734-319-604	56207
G59	Seal, metal clad	right inner extension (4WD)	1	95-04	0734-319-419	56209
n/i	Seal, metal clad	front differential (4WD)	1	95-04	0734-319-529	56210
n/i	Seal, metal clad	rear output (4WD)	1	95-04	0734-319-399	56211
n/i	Seal, metal clad	adapter housing (4WD)	1	95-04	0734-319-547	56212
n/i	Seal, metal clad	adapter housing (4WD)	1	02-04	0734-319-520	56213
n/i	Seal, metal clad	Range Rover (front input)	1	95-04	0734-319-520	56213
SEALING RINGS						
K10	Kit, sealing ring	ZF5HP24	1	95-04	n/a	K56300G
CLUTCH PLATES						
B80	Steel .118" 6.100" id 30T	(B) clutch	6	95-04	1058-370-050	56111
B81	Friction .061" 7.025" od 30T	(B) clutch	6	95-04	1058-270-025	56106C
B85	Friction .061" 5.042" od 40T	(A) clutch	6	95-04	1043-230-009	56106B
B84	Steel .082" 4.212" id 24T	(A) clutch	6	95-04	1058-370-053	56110
C87	Friction .061" 5.042" od 40T	(C) clutch	4	95-04	1043-230-009	56106B
C88	Steel .082" 4.212" id 24T	(C) clutch	4	95-04	1058-370-053	56110
D90	Friction .061" 7.025" od 30T	(D) clutch	6	95-04	1058-270-025	56106C
D91	Steel .118" 6.100" id 30T	(D) clutch	1	95-04	1058-370-050	56111
E96	Steel .118" 6.100" id 30T	(E) clutch	5	95-04	1058-370-050	56111
E97	Friction .061" 7.025" od 30T	(E) clutch	5	95-04	1058-270-025	56106C
G99	Friction .062" 5.627" od 30T	(F) clutch	6	95-06	1055-270-072	56106D
G100	Steel .071" 4.685" id 24T	(F) clutch	6	95-06	1055-374-030	56114
n/i	Steel .083" 6.100" id 30T	(B)/(D)/(E) clutch	sel	95-06	1058-370-050-083	56112
n/i	Steel .095" 6.100" id 30T	(B)/(D)/(E) clutch	sel	95-06	1058-370-050-095	56113
FILTERS						
K9	Kit, filter	ZF5HP24	1	95-04	AE	FK56800K
K9	Kit, filter	ZF5HP24A	1	95-04	AE	FK56800L
H125	Filter, oil	ZF5HP24	1	95-04	24-34-1-422-673	56800K
H125	Filter, oil	ZF5HP24A	1	95-04	01L-325-429	56800L
PUMP PARTS AND PUMPS						
A250	Pump assembly	ZF5HP24	1	95-04	AE	56200G-R
A250	Pump assembly	ZF5HP24A	1	99-04	AE	56200J-R
HARD PARTS						
H363	Valve body w/solenoids	ZF5HP24	1	95-04	AE	56785-R
BONDED PISTONS						
G420	Piston, bonded rubber	(F) clutch	1	95-04	n/a	87501
NOTES						

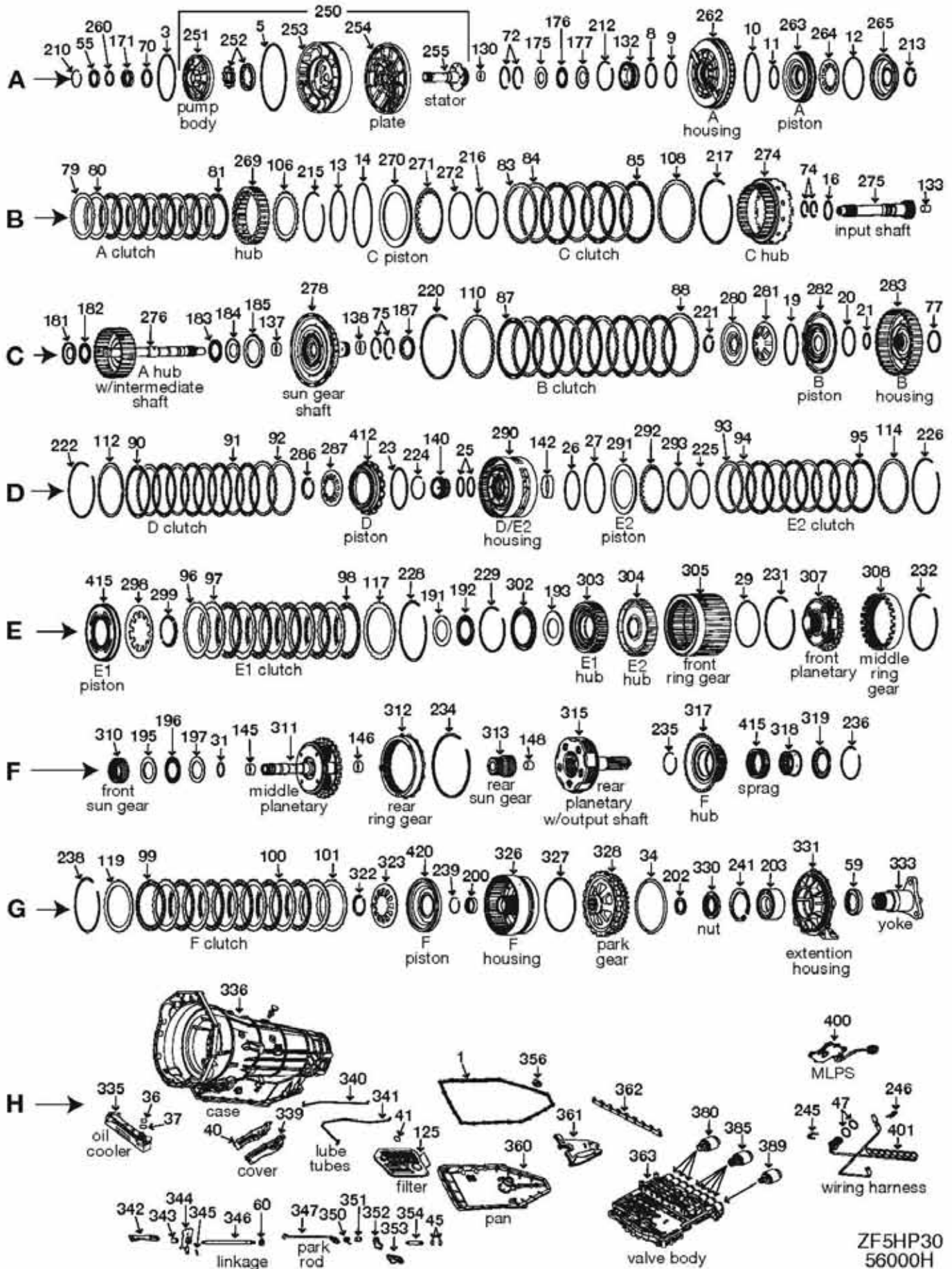

ZF5HP30
56000H

ILL	DESCRIPTION		QTY	YEAR	REFERENCE #	PART #
REBUILDER KITS						
K5	Master kit w/steels	5HP30 (w/o pistons)	1	91-01	AE	K5600H
K6	Master kit w/o steels	5HP30 (w/o pistons)	1	91-01	AE	K5600H-LS
K7	O/H gasket set w/seals-rings	5HP30 (w/o pistons)	1	91-01	AE	K56900H
GASKETS AND RUBBER COMPONENTS						
H1	Gasket, pan	fiber	1	91-01	24-11-1-211-400	13672
H41	O'ring	filter	1	91-01	0734-313-181	23067
METAL CLAD SEALS						
A55	Seal, metal clad 40x52x7mm	front	1	91-01	24-31-1-207-433	56200D
G59	Seal, metal clad	extension housing	1	91-01	n/a	56205
H60	Seal, metal clad	shift shaft	1	91-01	n/a	56208
SEALING RINGS						
K10	Kit, sealing ring	ZF5HP30	1	91-01	n/a	K56300H
CLUTCH PLATES						
B79	Steel .032" 5.905" id 24T (waved)	(A) clutch forward	1	91-01	1055-370-088	56117
B80	Steel .120" 4.690" id 24T	(A) clutch forward	5	91-01	1055-370-003	56115
B81	Friction .063" 5.627" od 30T	(A) clutch forward	5	91-01	1055-270-030	56106E
B83	Steel .035" 5.905" id 24T (waved)	(C) intermediate clutch	1	91-01	1055-372-008	56119
B84	Steel .120" 7.170" id 32T	(C) intermediate clutch	3	91-01	1055-371-003	56118
B85	Friction .063" 8.007" od 30T	(C) intermediate clutch	3	91-01	1055-271-025	56106F
C87	Friction .063" 8.007" od 30T	(B) direct clutch	5/6	91-01	1055-271-025	56106F
C88	Steel .120" 7.170" id 32T	(B) direct clutch	6/7	91-01	1055-371-003	56118
D90	Friction .063" 8.007" od 30T	(D) clutch	5	91-01	1055-271-025	56106F
D91	Steel .120" 7.170" id 32T	(D) clutch	5/6	91-01	1055-371-003	56118
D92	Steel .035" 5.905" id 24T (waved)	(D) clutch	1	91-01	1055-372-008	56119
D93	Steel .035" 5.905" id 24T (waved)	(E2) clutch	1	91-01	1055-372-008	56119
D94	Steel .120" 7.170" id 32T	(E2) clutch	4	91-01	1055-371-003	56118
D95	Friction .063" 8.007" od 30T	(E2) clutch	4	91-01	1055-271-025	56106F
E96	Steel .032" 5.905" id 24T (waved)	(E1) clutch	1	91-01	1055-370-088	56117
E97	Steel .071" 4.685" id 24T	(E1) clutch	5/6	91-01	1055-374-001	56114
E98	Friction .063" 5.627" od 30T	(E1) clutch	5/6	91-01	1055-270-030	56106E
G99	Friction .063" 5.627" od 30T	(F) overdrive clutch	6	91-01	1055-270-030	56106E
G100	Steel .071" 4.685" id 24T	(F) overdrive clutch	6	91-01	1055-374-001	56114
G101	Steel .032" 5.905" id 24T (waved)	(F) overdrive clutch	1	91-01	1055-370-088	56117
FILTERS						
K9	Kit, filter	ZF5HP30	1	91-01	AE	FK56800H
H125	Filter, oil	ZF5HP30	1	91-01	24-34-1-432-200	56800H
PUMP PARTS AND PUMPS						
A250	Pump assembly	ZF5HP30	1	91-01	AE	56200H-R
HARD PARTS						
H363	Valve body w/solenoids	ZF5HP30	1	91-01	AE	56985-R
BONDED PISTONS						
E412	Piston, bonded rubber	(D) clutch	1	91-01	0750-132-082	56505
E415	Piston, bonded rubber	(E1) clutch	1	91-01	0750-132-086	56506
G420	Piston, bonded rubber	(F) overdrive clutch	1	91-01	0750-132-072	56507
NOTES						

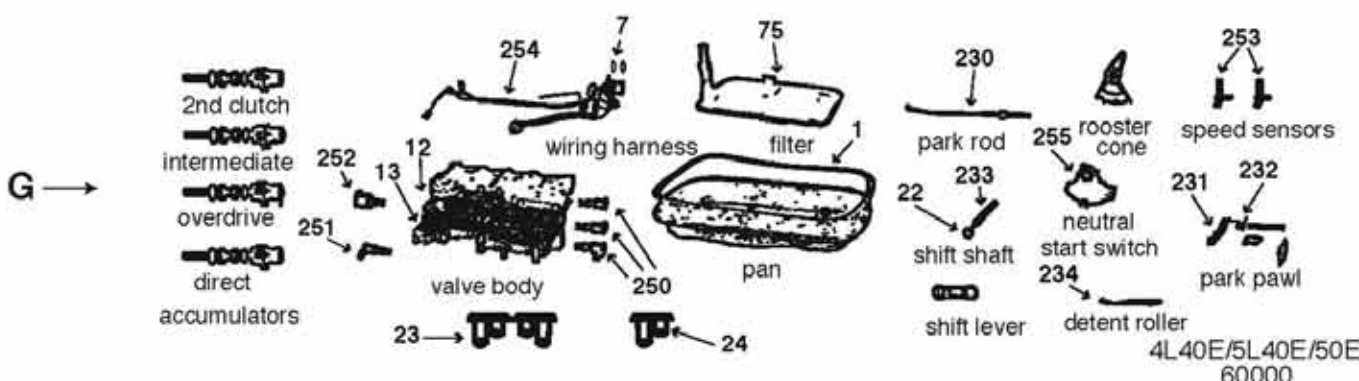
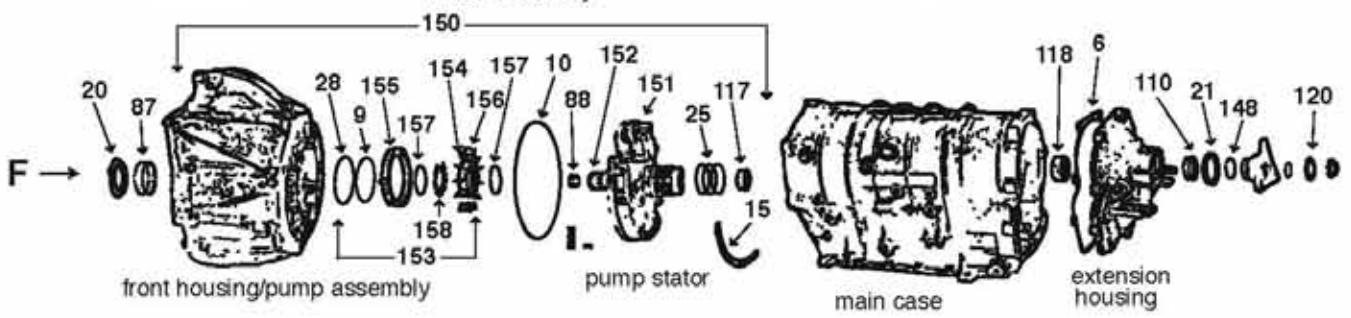
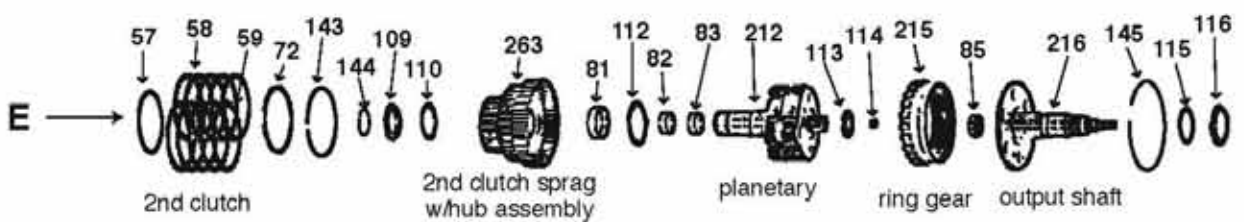
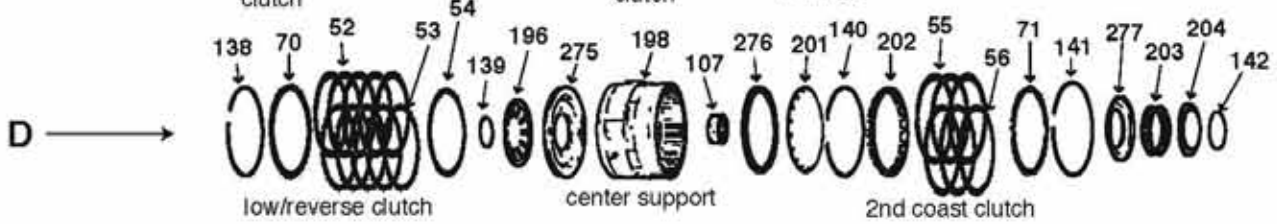
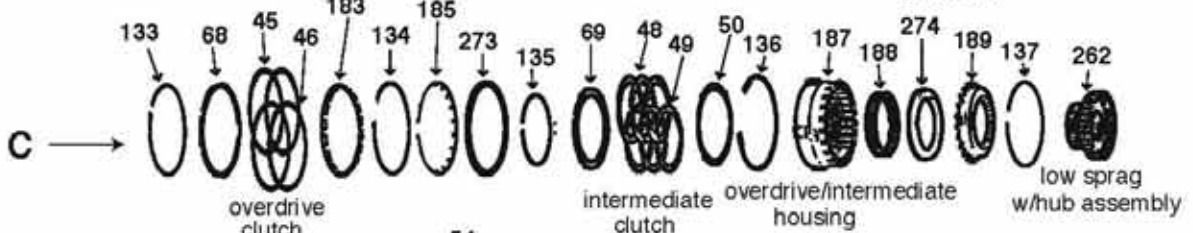
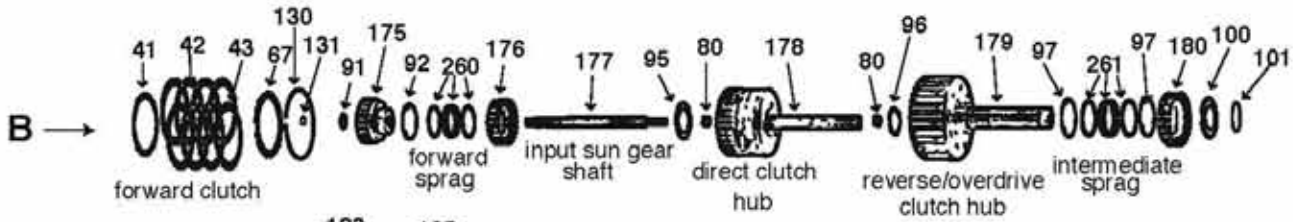
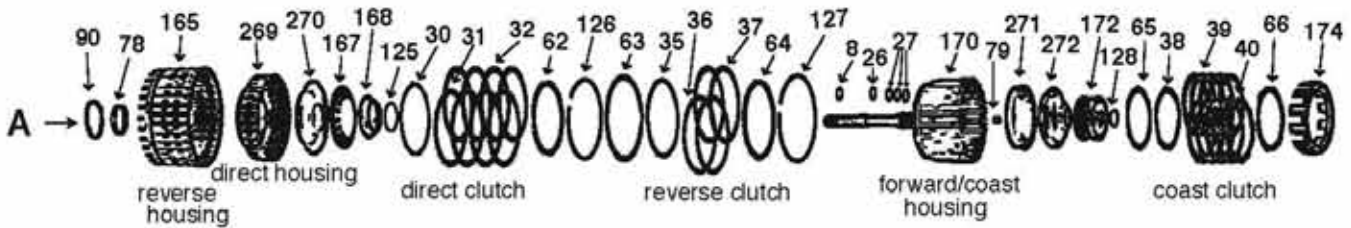

4L40E/5L40E/50E 60000

ILL	DESCRIPTION	QTY	YEAR	REFERENCE #	PART #
TECHNICAL MANUALS					
K53	Tech manual 4L40E/50E dis/assembly	1	91-02	83-5L40ETM	010-419
K53	Tech manual 5L50E dis/assembly	1	99-09	83-5L50ETM	010-328
REBUILDER KITS					
K5	Master kit w/steels	1	99-09	AE	K6000
K5	Master kit w/steels	1	03-09	AE	K6000C
K7	O/H gasket set w/seals-rings	1	99-09	AE	K60900
VALVE BODY KITS					
K15	Shift Kit®	1	99-07	n/a	K60908
K15	Shift Correction Package	1	99-07	n/a	S60908
K15	Kit, repair pump/valve body fixes	1	03-06	5L4-ACT-VL	K60964
K15	Kit, repair pump/valve body	1	03-06	5L4-ACT-VL5	K60965
GASKETS AND RUBBER COMPONENTS					
G1	Gasket, oil pan	1	00-09	96041861	14009R
K4	Kit, valve body gaskets	1	00-09	FDB-4992	13050
G6	Gasket, extension housing to case	1	00-09	96025413	13044
G7	O'ring	2	00-09	96041849	13045
A8	O'ring (teflon coated/green)	1	03-09	8662686	13766
F9	O'ring	1	00-09	24208663	13982
F10	O'ring	1	00-09	FDB-17911	13046
G12	Gasket, lower valve body	1	00-09	FDB-B36093	13047
G13	Gasket, upper valve body	1	00-09	FDB-B36094	13048
F15	Gasket, channel plate	1	00-09	FDB-B36095	13049
n/i	Seal (rubber)	1	00-09	8621283	13762
n/i	Seal (teflon)	1	00-09	8631877	13768
METAL CLAD SEALS					
F20	Seal, metal clad	1	00-09	96020366	60151
F21	Seal, metal clad	1	00-09	96020744	60155
F21	Seal, metal clad	1	03-09	96025254	60156
G22	Seal, metal clad	1	00-09	8644709	51202A
G23	Seal, tube	1	00-09	n/a	60159
G24	Seal, tube	1	00-09	n/a	60160
SEALING RINGS					
K12	Kit, sealing ring	1	00-09	FDB-B3474	K60903T
F25	Ring, sealing (scarf cut)	3	00-09	FDB-21785	60300
A26	Ring, sealing (solid)	1	00-09	FDB-21787	60303
A27	Ring, sealing (scarf cut)	3	00-09	FDB-21786	60301
F28	Ring, sealing (solid) teflon	1	00-09	FDB-21784	60302
CLUTCH PLATES					
A30	Steel, waved	1	99-09	n/a	60120
A30	Steel, waved	1	99-09	AE	60120-R
A31	Friction .063" 6.107" id 36T (external T)	4/5	99-09	96020157	60100
A32	Friction .063" 6.800" od 36T (internal T)	4/5	99-09	96024392	60101
A35	Steel, waved	1	99-09	n/a	60121
A35	Steel, waved	1	99-09	AE	60121-R
A36	Friction .063" 7.062" od 36T (internal T)	3	99-09	96020209	60102
A37	Friction .063" 6.464" id 36T (external T)	3	99-09	96020210	60103
A38	Steel, waved	1	99-09	n/a	60122
A38	Steel, waved	1	99-09	AE	60122-R
A39	Friction .063" 4.848" od 24T (internal T)	3	99-09	96020322	60104
A40	Friction .063" 4.126" id 12T (external T)	3	99-09	96020323	60105
B41	Steel, waved	1	99-09	n/a	60123
B41	Steel, waved	1	99-09	AE	60123-R
A42	Friction .063" 5.111" od 24T (internal T)	4	99-09	96020326	60106

4L40E•5L40E•5L50E

4L40E•5L40E•50E

ILL	DESCRIPTION	QTY	YEAR	REFERENCE #	PART #
CLUTCH PLATES (CONTINUED)					
A43	Friction .063" 4.126" id 24T (external T) forward clutch (1 sided)	4	99-09	96020327	60107
C45	Friction .063" 7.062" od 36T (internal T) overdrive clutch (1 sided)	3	99-09	96020209	60102
C46	Friction .063" 6.464" id 36T (external T) overdrive clutch (1 sided)	3	99-09	96020210	60103
C48	Friction .063" 5.307" od 24T (internal T) intermediate clutch (1 sided)	3	99-09	96020684	60108
C49	Friction .063" 4.122" id 24T (external T) intermediate clutch (1 sided)	3	99-09	96020685	60109
C50	Steel, waved intermediate clutch	1	99-09	156765	60124
C50	Steel, waved intermediate clutch	1	99-09	AE	60124-R
D52	Friction .063" 6.800" od 36T (internal T) low/reverse clutch (1 sided)	5	99-09	96024392	60101
D53	Friction .063" 6.107" id 29T (external T) low/reverse clutch (1 sided)	5	99-09	96020780	60110
D54	Steel, waved low/reverse (cushion)	1	99-09	n/a	60125
D54	Steel, waved low/reverse (cushion)	1	99-09	AE	60125-R
D55	Friction .063" 6.800" od 36T (internal T) 2nd coast clutch (1 sided)	3	03-09	96024392	60101
D55	Friction .065" 6.920" od 36T (internal T) BMW/AWD (2nd coast clutch 1 sided)	2	99-09	n/a	60111
D56	Friction .063" 6.107" id 36T (external T) 2nd coast clutch (1 sided)	3	03-09	96020157	60100
D56	Friction .063" 6.426" id 6T (external T) BMW/AWD (2nd coast clutch 1 sided)	2	99-09	n/a	60112
E57	Steel, waved 2nd clutch (cushion)	1	99-09	n/a	60126
E57	Steel, waved 2nd clutch (cushion)	1	99-09	AE	60126-R
E57	Steel, waved 2nd clutch (cushion)	1	03-09	n/a	60126A
E57	Steel, waved 2nd clutch (cushion)	1	03-09	AE	60126A-R
E58	Friction .063" 5.111" od 24T (internal T) 2nd clutch (1 sided)	6	03-09	96022840	60113
E58	Friction .063" 5.427" od 24T (internal T) BMW/AWD (2nd clutch 1 sided)	4	99-09	n/a	60115
E59	Friction .063" 4.475" id 24T (external T) 2nd clutch (1 sided)	6	03-09	96022841	60114
E59	Friction .063" 4.480" id 24T (external T) BMW/AWD (2nd clutch 1 sided)	4	99-09	n/a	60116
PRESSURE PLATES					
A62	Plate, pressure .199" 6.112" id 18T direct clutch	1	99-09	AE	60724-R
A63	Plate, pressure .119" 36T reverse clutch (apply)	1	99-09	AE	60725-R
A64	Plate, pressure .198" 6.475" id 18T reverse clutch	1	99-09	AE	60715-R
A65	Plate, pressure 6T coast clutch (apply)	sel	99-09	AE	60716-R
A66	Plate, pressure .078" 4.125" id 6T coast clutch (backing)	1	99-09	AE	60717-R
B67	Plate, pressure .200" 12T forward clutch (backing)	1	00-09	AE	60718-R
C68	Plate, pressure .198" 6.475" id 18T overdrive clutch	1	99-09	AE	60715-R
C69	Plate, pressure .198" 12T intermediate clutch	1	99-09	AE	60719-R
D70	Plate, pressure .198" 18T low/reverse clutch	1	99-09	AE	60720-R
D71	Plate, pressure .200" 6T 2nd coast clutch	1	99-09	AE	60723-R
D71	Plate, pressure .199" 6.112" id 18T Cadillac (2nd coast clutch)	1	03-09	AE	60724-R
E72	Plate, pressure .198" 5.460" od 12T BMW/AWD (2nd clutch)	1	99-09	AE	60721-R
E72	Plate, pressure .198" 5.150" od 12T Cadillac (2nd clutch)	1	03-09	AE	60722-R
FILTERS					
K9	Kit, filter (w/outlet tube spacer) (w/plastic shroud around intake) deep pan	1	99-09	AE	FK60710
K9	Kit, filter (w/o outlet tube spacer) (w/o outlet tube spacer)	1	99-09	AE	FK60710A
K9	Kit, filter (w/outlet tube spacer) deep pan	1	99-09	AE	FK60710B
G75	Filter (w/outlet tube spacer) (w/plastic shroud around intake) deep pan	1	99-09	96023081	60710
G75	Filter (w/o outlet tube spacer) shallow pan	1	99-09	96022597	60710A
G75	Filter (w/outlet tube spacer) deep pan	1	99-09	96022598	60710B
BUSHINGS					
K12	Kit, bushing 4L40E/5L40E/5L50E	1	99-09	AE	K60901
A78	Bushing 4L40E/5L40E/5L50E (reverse housing)	1	99-09	n/a	60003
A79	Bushing forward/coast clutch housing	1	99-09	n.a	60002
B80	Bushing 4L40E/5L40E/5L50E (direct hub)	2	99-09	n/a	60004
E81	Bushing 4L40E/5L40E/5L50E2nd (coast clutch hub)	1	99-09	n/a	60006
E82	Bushing 4L40E/5L40E/5L50E (planetary front)	1	99-09	n/a	60007
E83	Bushing 4L40E/5L40E/5L50E (planetary rear)	1	99-09	n/a	60008
E85	Bushing 4L40E/5L40E/5L50E (output shaft front)	1	99-09	n/a	60009

ILL	DESCRIPTION	QTY	YEAR	REFERENCE #	PART #
BUSHINGS (CONTINUED)					
F87	Bushing 4L40E/5L40E/5L50E (front/bell housing)	1	99-09	n/a	60005
F88	Bushing 4L40E/5L40E/5L50E (stator support front)	1	99-09	n/a	60001
WASHERS/BEARINGS/RACES/SHIMS					
K13	Kit, thrust washer 4L40E/5L40E/5L50E	1	99-09	AE	K60907
K13	Kit, thrust bearing 4L40E/5L40E/5L50E	1	99-09	AE	K60906
A90	Thrust washer (w/1 outer 3 inner tabs) stator shaft to reverse housing	sel	99-09	n/a	60401
B91	Bearing, thrust forward/coast housing to hub	1	99-09	n/a	60416
B92	TW .049" 3 inner tabs (flat on 1 side) plastic forward sprag to inner race	1	99-09	n/a	60404
B95	Thrust washer .062" 3 tabs plastic forward sprag to direct clutch hub	1	99-09	n/a	60405
B96	Thrust washer .064" 3 tabs plastic direct hub to reverse/overdrive hub	1	99-09	n/a	60403
B97	TW .040" 3 inner tabs (flat on both sides) plastic intermediate sprag	2	99-09	n/a	60402
B100	Bearing, thrust intermediate sprag to low sprag	1	99-09	n/a	60407
B101	Washer, spacer intermediate sprag to low/reverse race	1	99-09	n/a	60513
C104	Bearing, thrust low/reverse clutch hub to center support	1	99-09	n/a	60414
D107	Bearing, caged type center support	1	99-09	n/a	60503
E109	Bearing, thrust center support to 2nd clutch sprag	1	99-09	n/a	60409
E110	Bearing, thrust 2nd clutch sprag to bearing	1	99-09	n/a	60415
E112	Thrust washer (3 tabs plastic) 2nd coast clutch hub to planetary	1	99-09	n/a	60406
E113	Bearing, thrust planetary to output shaft	1	99-09	n/a	60413
E114	Bearing, caged type mainshaft pilot inside planetary	1	99-09	n/a	60510
E115	Bearing, race output shaft to extension housing	1	99-09	n/a	60417
E115	Bearing, thrust output shaft to extension housing	1	99-09	n/a	60418
F117	Bearing, caged type stator shaft (rear)	1	99-09	n/a	60501
E116	Thrust washer (3 tabs plastic) output shaft to extension housing (AWD)	1	99-09	n/a	60408
F118	Bearing, caged type 5L40E (extension housing front)	1	99-09	n/a	60511
F119	Bearing, caged type 5L50E (extension housing front)	1	99-09	n/a	60512
F120	Washer, spacer output shaft to rear yoke	1	99-09	n/a	60412
SNAP RINGS					
A125	Snap ring direct clutch retainer	1	99-09	n/a	60601-R
A126	Snap ring direct clutch pressure plate	1	99-09	n/a	60602-R
A127	Snap ring reverse clutch pressure plate	1	99-09	n/a	60604-R
A128	Snap ring 2nd coast clutch retainer	1	99-09	n/a	60605-R
B130	Snap ring forward clutch pressure plate	1	99-09	n/a	60606-R
B131	Snap ring forward sprag race to input shaft	1	99-09	n/a	60607-R
C133	Snap ring overdrive clutch pressure plate	1	99-09	n/a	60609-R
C134	Snap ring overdrive clutch return spring	1	99-09	n/a	60608-R
C135	Snap ring intermediate clutch pressure plate	1	99-09	n/a	60616-R
C136	Snap ring (beveled true-ark type) overdrive/intermediate housing to case	1	99-09	n/a	60610-R
C137	Snap ring intermediate to overdrive/inter housing	1	99-09	n/a	60617-R
D138	Snap ring low/reverse clutch pressure plate	1	99-09	n/a	60602-R
D139	Snap ring low/reverse clutch return spring	1	99-09	n/a	60603-R
D140	Snap ring BMW (2nd clutch return spring)	1	99-09	n/a	60618-R
D140	Snap ring Cadillac (2nd clutch return spring)	1	03-09	n/a	60619-R
D141	Snap ring 7.312" od BMW (2nd clutch pressure plate)	sel	99-09	n/a	60611-R
D141	Snap ring 7.250" od Cadillac (2nd clutch pressure plat)	sel	03-09	n/a	60612-R
D142	Snap ring 2nd clutch retainer	1	99-09	n/a	60615-R
E143	Snap ring 5.415" od Cadillac (2nd clutch pressure plate)	sel	03-09	n/a	60612A-R
E143	Snap ring 5.765" od BMW/AWD (2nd clutch pressure plate)	sel	99-09	n/a	60611A-R
E144	Snap ring bearing to planetary	1	99-09	n/a	60620-R
E145	Snap ring ring gear to output shaft	1	99-09	n/a	60622-R
F148	Snap ring rear yoke spacer	1	99-09	n/a	60623-R

4L40E•5L40E•5L50E

4L40E•5L40E•50E

ILL	DESCRIPTION	QTY	YEAR	REFERENCE #	PART #
PUMP PARTS AND PUMPS					
F150	Pump, assembly	1	99-09	AE	60200-R
F150	Pump, assembly	1	03-09	96042812	60201-R
F150	Pump, assembly	1	04-06	96042835	60201A-R
F150	Pump, assembly	1	04-06	96042829	60201B-R
F151	Stator, pump w/shaft	1	99-09	AE	60202-R
F151	Stator, pump w/shaft	1	03-09	AE	60203-R
F152	Shaft, pump stator	1	99-09	n/a	60969
F152	Shaft, pump stator	1	99-09	AE	60969-R
F152	Shaft, pump stator	1	03-09	n/a	60970
F152	Shaft, pump stator	1	03-09	AE	60970-R
F153	Kit, rotor slide, guide (13 vanes)	1	99-09	AE	K32800B
F154	Rotor, pump (13 vane)	1	99-09	n/a	32802B
F155	Slide, pump .709"-.710"	1	99-09	n/a	32803
F156	Vane, pump	13	99-09	n/a	32800
F157	Ring, pump vane (solid)	1	99-09	n/a	32322SP
F158	Guide, rotor (13 vane type)	1	99-09	n/a	32422B
HARD PARTS					
A165	Housing, reverse	1	99-09	n/a	60909-R
A165	Housing, reverse	1	99-09	n/a	60909A-R
A167	Spring, diaphragm type	1	99-09	n/a	60912-R
A168	Retainer, direct clutch	1	99-09	n/a	60913-R
A170	Housing, forward/coast clutch	1	99-09	n/a	60920-R
A170	Housing, forward/coast clutch	1	03-09	n/a	60920A-R
A172	Retainer, w/springs	1	99-09	n/a	60922-R
A174	Housing, coast clutch	1	99-09	n/a	60925-R
A174	Housing, coast clutch	1	03-09	n/a	60925A-R
B175	Hub, inner race	1	99-09	n/a	60927-R
B176	Hub, outer race	1	99-09	n/a	60929-R
B177	Shaft, input sun gear	1	99-09	n/a	60930-R
B177	Shaft, input sun gear	1	03-09	n/a	60930A-R
B178	Hub, direct clutch w/shaft	1	99-09	n/a	60932-R
B178	Hub, direct clutch w/shaft	1	03-09	n/a	60932A-R
B179	Hub, w/shaft reverse/overdrive clutch	1	99-09	n/a	60933-R
B179	Hub, w/shaft reverse/overdrive clutch	1	03-09	n/a	60933A-R
B180	Hub, outer race overdrive clutch	1	99-09	n/a	60936-R
C183	Ring, apply overdrive clutch	1	99-09	n/a	60940-R
C185	Spring, return diaphragm type	1	99-09	n/a	60941-R
C187	Housing, overdrive/intermediate	1	99-09	n/a	60943-R
C187	Housing, overdrive/intermediate	1	03-09	n/a	60943A-R
C188	Retainer, w/spring intermediate	1	99-09	n/a	60944-R
C189	Housing, intermediate clutch piston	1	99-09	n/a	60945-R
D196	Spring, return diaphragm type	1	99-09	n/a	60950-R
D198	Support, center (6T)	1	99-09	n/a	60951-R
D198	Support, center (24T)	1	99-09	n/a	60951A-R
D198	Support, center (29T)	1	03-09	n/a	60951B-R
D201	Spring, return diaphragm type	1	99-09	n/a	60955-R
D201	Spring, return diaphragm type	1	03-09	n/a	60955A-R
D202	Ring, apply 2nd coast clutch	1	99-09	n/a	60956-R
D202	Ring, apply 2nd coast clutch	1	03-09	n/a	60956A-R
D203	Retainer, w/springs 2nd clutch	1	99-09	n/a	60958-R
D203	Retainer, w/springs 2nd clutch	1	03-09	n/a	60958A-R
D204	Retainer, 2nd coast clutch	1	03-09	n/a	60959-R
E209	Hub, outer race 2nd clutch	1	99-09	n/a	60962-R

ILL	DESCRIPTION	QTY	YEAR	REFERENCE #	PART #
HARD PARTS (CONTINUED)					
E212	Planetary, assembly 23T/35T narrow gears	1	99-09	n/a	60968-R
E212	Planetary, assembly	1	03-09	n/a	60968A-R
E212	Planetary, assembly 23T short 1 id groove	1	00-09	n/a	60968B-R
E215	Gear, ring	1	99-09	n/a	60974-R
E215	Gear, ring	1	03-09	n/a	60974A-R
E215	Gear, ring	1	04-06	n/a	60974B-R
E216	Shaft, output	1	99-09	n/a	60975-R
E216	Shaft, output	1	03-09	n/a	60975A-R
E216	Shaft, output	1	04-06	n/a	60975B-R
G230	Rod, park	1	03-09	n/a	60980-R
G231	Pawl, park	1	03-09	n/a	60982-R
G232	Spring, park pawl	1	03-09	n/a	60983-R
G233	Shaft, shift	1	03-09	n/a	60985-R
G234	Roller, detent spring	1	03-09	n/a	60986-R
ELECTRICAL COMPONENTS					
G250	Solenoid	3	00-09	96041866	5A-380
G251	Solenoid (PWM)	1	00-09	24212690	5A-393
G252	Solenoid	1	03-09	24225825	5A-419A
G253	Snap ring	3	03-09	96041860	95237-62603
G254	Harness, wiring	1	99-09	n/a	16A-145
G254	Harness, wiring	1	03-09	96042847	16A-146
G255	Switch, neutral start (PRNDL)	1	03-09	96042540	05-127
SPRAGS					
B260	Sprag, (26 elements)	1	99-09	n/a	60560
B261	Sprag	1	99-09	n/a	60561
C262	Sprag, assembly	1	99-09	n/a	60562
E262	Sprag, assembly	1	99-09	AE	60562-R
E263	Sprag, assembly	1	99-09	n/a	60563
E263	Sprag, assembly	1	99-09	AE	60563-R
E263	Sprag, assembly	1	03-09	AE	60563A-R
E263	Sprag, assembly	1	00-09	AE	60563B-R
BONDED PISTONS					
K43	Kit, bonded apply pistons	1	99-01	FDB-B4895	K60585
K43	Kit, bonded apply pistons	1	02-09	FBD-B4894	K60586
A269	Piston, bonded rubber	1	00-09	96020351	60525
A269	Piston, bonded rubber	1	03-09	n/a	60525A
A270	Piston, bonded rubber	1	00-09	96021174	60522
A271	Piston, bonded rubber	1	00-09	96023901	60520
A272	Piston, bonded rubber	1	00-09	96020306	60521
C273	Piston, bonded rubber	1	99-09	96025338	60523
C274	Piston, bonded rubber	1	00-09	96020682	60526
D275	Piston, bonded rubber	1	99-99	96020153	60527
D275	Piston, bonded rubber	1	00-09	96022480	60527A
D276	Piston, bonded rubber	1	99-01	96020191	60524
D276	Piston, bonded rubber	1	02-09	96025338	60523
D277	Piston, bonded rubber	1	99-99	96020194	60528
D277	Piston, bonded rubber	1	00-02	96022481	60528A
D277	Piston, bonded rubber	1	02-09	96024086	60528B
NOTES					

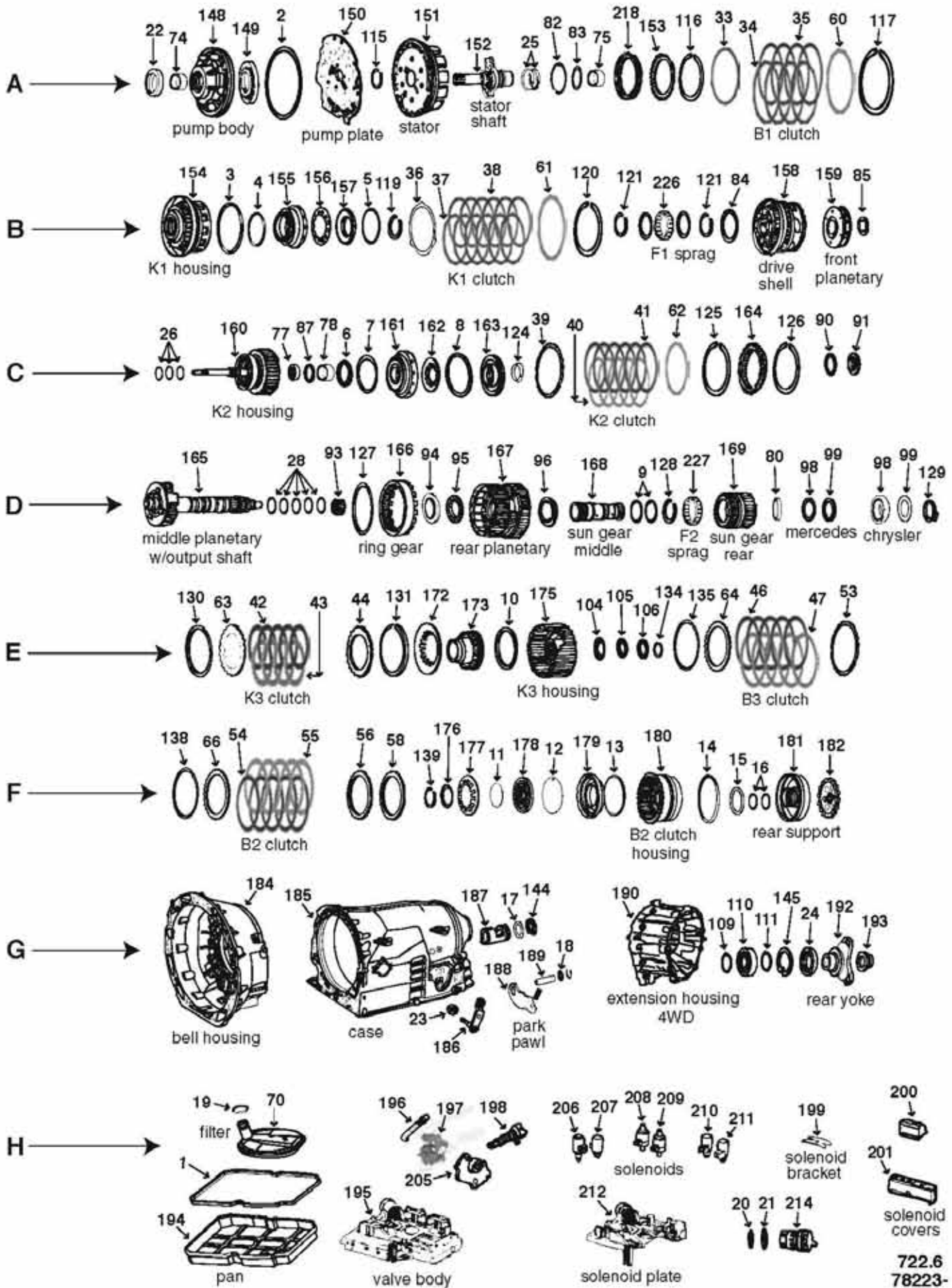

722.6
78223-

ILL	DESCRIPTION	QTY	YEAR	REFERENCE #	PART #
TECHNICAL MANUALS					
K53	Tech manual 722.6 dis/assembly	1	98-10	722.6 update	010-477
K53	Update handbook 722.6	1	98-10	722.6 manual	010-478
K53	Video/manual 722.6	1	98-10	722.6 video	010-855
REBUILDER KITS					
K4	Master deluxe rebuilding kit	1	96-97	AE	78223-10004
K4	Master deluxe rebuilding kit	1	96-97	AE	78223-10104
K4	Master deluxe rebuilding kit	1	98-01	AE	78223-10014
K4	Master deluxe rebuilding kit	1	98-01	AE	78223-10114
K4	Master deluxe rebuilding kit	1	02-10	AE	78223-10024
K4	Master deluxe rebuilding kit	1	02-10	AE	78223-10124
K4	Master deluxe rebuilding kit	1	04-10	AE	20223-10204
K4	Master deluxe rebuilding kit	1	04-10	AE	20223-10304
K5	Master kit w/steels	1	96-97	141901	78223-11004
K5	Master kit w/steels	1	96-97	AE	78223-11104
K5	Master kit w/steels	1	98-01	141901A	78223-11014
K5	Master kit w/steels	1	98-01	AE	78223-11114
K5	Master kit w/steels	1	02-10	141901B	78223-11024
K5	Master kit w/steels	1	02-10	AE	78223-11124
K5	Master kit w/steels	1	04-10	141901C	20223-11204
K5	Master kit w/steels	1	04-10	AE	20223-11304
K6	Master kit w/o steels	1	96-97	141901LS	78223-12004
K6	Master kit w/o steels	1	96-97	AE	78223-12104
K6	Master kit w/o steels	1	98-01	141901ALS	78223-12014
K6	Master kit w/o steels	1	98-01	AE	78223-12114
K6	Master kit w/o steels	1	02-10	141901BLS	78223-12024
K6	Master kit w/o steels	1	02-10	AE	78223-12124
K6	Master kit w/o steels	1	04-10	141901CLS	20223-12204
K6	Master kit w/o steels	1	04-10	AE	20223-12304
K7	O/H gasket set w/seals-rings	1	97-10	2415	78223-13004
K7	O/H gasket set w/seals-rings	1	97-10	2411	78223-13104
VALVE BODY KITS					
K15	Shift Kit®	1	97-08	SK® 722.6	78223-17009
GASKETS AND RUBBER COMPONENTS					
H1	Gasket, oil pan	1	97-10	140-271-0081	78223-20004
A2	O'ring	1	97-10	n/a	78223-21004
B3	Seal, lathe cut	1	97-10	n/a	78223-24604
B4	Seal, lathe cut	1	97-10	n/a	78223-24704
B5	O'ring	1	97-10	n/a	78223-21104
C6	Seal, lathe cut	1	97-10	n/a	78223-24804
C7	O'ring	1	97-10	n/a	78223-21304
C8	O'ring	1	97-10	n/a	78223-21404
D9	O'ring	2	97-10	n/a	78223-21504
E10	Seal, lathe cut	1	97-10	n/a	78223-25004
F11	Seal, lathe cut	1	97-10	n/a	78223-25104
F12	Seal, lathe cut	1	97-10	n/a	78223-25204
F13	Seal, lathe cut	1	97-10	n/a	78223-25304
F14	Seal, lathe cut	1	97-10	n/a	78223-25404
F15	Seal, lathe cut	1	97-10	n/a	78223-25504
F16	O'ring	1	97-10	n/a	78223-21704
G17	O'ring	2	97-10	140-997-2345	78223-22004
G18	O'ring	1	97-10	n/a	78223-22204
H19	O'ring	1	97-10	n/a	78223-22504
H20	O'ring	1	97-10	026-997-4048	78223-22704

722.6•W5A580•W5A330

722.6•W5A580•W5A330

ILL	DESCRIPTION	QTY	YEAR	REFERENCE #	PART #
GASKETS AND RUBBER COMPONENTS (CONTINUED)					
H21	O'ring 722.6 (connector outer large)	1	97-10	026-997-4148	78223-22904
n/i	O'ring 722.6 (filler tube)	1	97-10	n/a	78223-23504
n/i	Boot 722.6 (dipstick tube to case)	1	97-10	n/a	78223-24004
METAL CLAD SEALS					
A22	Seal, metal clad 722.6 (front)	1	96-10	010-997-49-47	55206
G23	Seal, metal clad 722.6 (manual lever shaft)	1	96-10	006-997-01-47	55210
G24	Seal, metal clad 722.6 (extension housing)	1	96-10	140-997-08-46	78223-30104
SEALING RINGS					
K10	Kit, sealing ring 722.6 (teflon)	1	96-10	FDB3458	78223-31500
A25	Ring, sealing (teflon) .077" 2.295" od 722.6 (stator support)	2	97-10	n/a	78223-33204
C26	Ring, sealing (plastic) .092" 1.212" od 722.6 (input shaft K-2 housing)	3	97-10	n/a	78223-33500
D27	Ring, sealing (plastic) 722.6 (output shaft/middle planetary)	1	97-10	n/a	78223-33604
D28	Ring, sealing (plastic) .092" 1.375"od 722.6 (output shaft/middle planetary)	4	97-10	n/a	78223-33804
CLUTCH PLATES					
A33	Steel, dished 6.069" id 3T 722.6 (B1 clutch cushion)	1	96-10	n/a	78223-37603
A34	Steel .071" 6.065" id 12T 722.6 (B1 clutch)	1	96-10	140-272-0226	78223-37804
A34	Steel .110" 6.065" id 12T 722.6 (B1 clutch)	3	02-10	140-272-2825	78223-38004
A34	Steel .138" 6.065" id 12T 722.6 (B1 clutch)	2/3	96-01	140-272-0326	78223-38104
A34	Steel .154" 6.065" id 12T 722.6 (B1 clutch)	1	96-10	140-272-0426	78223-38204
A35	Friction .084" 6.796" od 30T 722.6 (B1 clutch)	3/4	96-01	140-272-0025	78223-35104
A35	Friction .081" 6.796" od 30 internal teeth W5A330 (B1 clutch)	5	04-10	52108507AA	20223-35304
A35	Friction .081" 6.065" id 12 external teeth W5A330 (B1 clutch)	5	04-10	52108508AA	20223-35404
B36	Steel, dished 6.069" id 3T 722.6 (K1 clutch cushion)	1	96-10	n/a	78223-37603
B37	Steel .071" 6.065" id 12T 722.6 (K1 clutch)	1	96-10	140-272-0226	78223-37804
B37	Steel .110" 6.065" id 12T 722.6 (K1 clutch)	5	02-10	140-272-2826	78223-38004
B37	Steel .138" 6.065" id 12T 722.6 (K1 clutch)	3/5	96-01	140-272-0326	78223-38104
B37	Steel .154" 6.065" id 12T 722.6 (K1 clutch)	1	96-10	140-272-0426	78223-38204
B38	Friction .084" 6.796" od 30T 722.6 (K1 clutch)	4/6	96-10	140-372-0025	78223-35104
B38	Friction .081" 6.796" od 30 internal teeth W5A330 (K1 clutch 1-sided)	5	04-10	52108507AA	20223-35304
B38	Friction .081" 6.065" id 12 external teeth W5A330 (K1 clutch 1-sided)	5	04-10	52108508AA	20223-35404
C39	Steel, dished narrow 5.770" id 3T 722.6 (K2 clutch cushion)	1	96-10	n/a	78223-38603
C40	Friction .084" 5.250" id 36T (small id) 722.6 (K2 clutch)	4/5	96-01	210-272-0025	78223-35804
C40	Friction .084" 5.450" id 36T (large id) 722.6 (K2 clutch)	6	96-10	140-272-0125	78223-35904
C40	Friction .062" 6.475" od 36T 722.6 (K2 clutch)	sel	96-01	141706-160	78223-36004
C41	Steel .071" 5.770" id 30T 722.6 (K2 clutch)	1	96-10	140-272-0626	78223-38804
C41	Steel .110" 5.770" id 30T 722.6 (K2 clutch)	3/5	02-10	140-272-2926	78223-38904
C41	Steel .138" 5.770" id 30T 722.6 (K2 clutch)	2/3	96-01	140-272-0726	78223-39004
E42	Friction .063" 4.486" od 24T 722.6 (K3 clutch)	3/4	96-97	140-272-0225	78223-36204
E42	Friction .085" 4.486" od 24T 722.6 (K3 clutch)	5	98-10	140-272-0725	78223-36304
E42	Friction .082" 4.486" od 24T internal T W5A330 (K3 clutch 1-sided)	5	04-10	52108528AA	20223-36404
E42	Friction .083" 3.465" id 24T external T W5A330 (K3 clutch 1-sided)	5	04-10	52108529AA	20223-36504
E43	Steel .063" 3.465" id 24T 722.6 (K3 clutch)	1	96-10	140-272-1026	78223-39304
E43	Steel .109" 3.465" id 24T 722.6 (K3 clutch)	4	96-10	140-272-2726	78223-39404
E43	Steel .138" 3.465" id 24T 722.6 (K3 clutch)	3/4	96-97	140-272-1126	78223-39504
E44	Steel, dished 3.465" id 4T 722.6 (K3 clutch cushion)	1	96-10	AE	78223-39803
E46	Friction .063" 7.085" od 46T 722.6 (B3 clutch)	3/4	96-10	140-272-0626	78223-36804
E47	Steel .071" 6.100" id 30T 722.6 (B3 clutch)	3/4	96-10	140-272-1826	78223-40004
E53	Steel, dished 6.100" id 3T 722.6 (B3 clutch cushion)	1	96-10	AE	78223-40303
F54	Friction .063" 5.219" od 40 external teeth 722.6 (B2 clutch)	4/5	96-10	140-272-0026	78223-37004
F55	Steel .071" 6.097" id 24 internal teeth 722.6 (B2 clutch)	3/4	96-10	140-272-0425	78223-40504
F56	Steel .070" 5.219" id 40T 722.6 (B2 clutch bottom)	1	96-10	n/a	78223-40604
F58	Steel, dished 5.219" id 3T 722.6 (B2 clutch cushion)	1	96-10	AE	78223-40903

ILL	DESCRIPTION	QTY	YEAR	REFERENCE #	PART #
PRESSURE PLATES					
A60	Pressure plate .155" 6.063" id 12T	1	96-10	AE	78223-41203
B61	Pressure plate .155" 6.063" id 12T	1	96-10	AE	78223-41203
C62	Pressure plate .160" 5.765" id 30T	1	96-10	AE	78223-41603
E63	Pressure plate .155" 3.465" id 24T	1	96-97	AE	78223-42003
E64	Pressure plate .255" 6.100" id 30T	1	96-10	AE	78223-42503
F66	Pressure plate .255" 5.210" id 40T	1	96-10	AE	78223-43003
FILTERS					
K9	Kit, filter	1	96-10	AE	78223-44500
H70	Filter	1	97-10	140-277-00-95	78223-45104
BUSHINGS					
K12	Kit, bushing	1	96-10	AE	78223-50004
A74	Bushing	1	96-10	n/a	78223-50704
A75	Bushing	1	96-10	n/a	78223-51204
C77	Bushing (teflon)	1	04-10	Dodge	78223-51704
C78	Bushing	1	96-10	n/a	78223-52004
D80	Bushing	1	96-10	n/a	78223-52504
WASHERS/BEARINGS/RACES/SHIMS					
A82	Bearing, thrust	1	96-10	n/a	78223-56204
A83	Bearing, caged (needle type)	1	96-10	n/a	78223-56404
B84	Bearing, thrust	1	96-10	Mercedes	78223-56604
B84	Bearing, thrust 2 tabs 2.922" od 28 roller	1	04-10	Dodge	20223-56704
B85	Bearing, thrust	1	96-10	n/a	78223-56904
B85	Bearing, thrust 2 tabs .381" oh 1.962" id	1	04-10	Dodge	20223-57004
C87	Bearing, thrust 2 tabs	1	04-10	Dodge	20223-57204
C90	Race, bearing .031" 1.059" id 1.685" od	1	96-10	n/a	78223-57404
C91	Bearing, thrust .129" .950" id 1.754" od	1	96-10	n/a	78223-57604
D93	Bearing, caged .497" 1.335" od	1	96-10	n/a	78223-57804
D94	Race, bearing	1	96-10	Mercedes	78223-58004
D94	Race, bearing	1	04-10	Dodge	20223-58104
D95	Bearing, thrust	1	96-10	Mercedes	78223-58404
D95	Bearing, thrust	1	04-10	Dodge	20223-58500
D96	Bearing, thrust	1	96-10	Mercedes	78223-58704
D96	Bearing, thrust 2 tabs	1	04-10	Dodge	20223-57204
D98	Bearing, thrust	1	96-10	n/a	78223-59004
D98	Bearing, ball .397" 1.903" id 2.558" od	1	04-10	Dodge	20223-59104
D99	Race, bearing	1	96-10	Mercedes	78223-59304
D99	Washer .040" 1.919" id 2.553" od	1	04-10	Dodge	20223-59404
E104	Race, bearing recessed 1.405" id 2.198" od	1	96-10	n/a	78223-59604
E105	Bearing, thrust .078" 1.385" id 1.840" od	1	96-10	n/a	78223-59804
E106	Race, bearing .121" 1.385" id 1.822" od	1	96-10	Mercedes	78223-60004
E106	Race, bearing .132" 1.385" id 1.822" od	1	04-10	Dodge	20223-60104
G109	Washer, shim .008"	sel	96-10	n/a	78223-60404
G109	Washer, shim .012"	sel	96-10	n/a	78223-60504
G109	Washer, shim .016"	sel	96-10	n/a	78223-60604
G109	Washer, shim .020"	sel	96-10	n/a	78223-60704
G110	Bearing, ball .629" 1.257" id 2.442" od	1	96-10	n/a	78223-60904
G111	Washer, shim .008"	sel	96-10	n/a	78223-60404
G111	Washer, shim .012"	sel	96-10	n/a	78223-60504
G111	Washer, shim .016"	sel	96-10	n/a	78223-60604
G111	Washer, shim .020"	sel	96-10	n/a	78223-60704

722.6•W5A580•W5A330

722.6•W5A580•W5A330

ILL	DESCRIPTION	QTY	YEAR	REFERENCE #	PART #
SNAP RINGS					
A115	Ring, snap stator shaft	1	96-10	AE	78223-62103
A116	Ring, snap 5.446" od (retainer type)	1	96-10	AE	78223-62303
A117	Ring, snap .125" 7.250" od	sel	96-10	AE	78223-62503
B119	Ring, snap .078" 3.211" od	1	96-10	AE	78223-63003
B120	Ring, snap .125" 7.250" od	sel	96-10	AE	78223-62503
B121	Ring, snap .058" 2.390" od	2	96-10	AE	78223-63403
C124	Ring, snap .079" 1.707" od	1	96-10	AE	78223-63603
C125	Ring, snap	sel	96-10	AE	78223-63803
C126	Ring, snap .077" 7.385" od	1	96-10	AE	78223-64103
D127	Ring, snap	1	96-10	Mercedes	78223-64303
D127	Ring, snap .076" 5.237" od	1	04-10	Dodge	78223-64503
D128	Ring, snap .038" 2.218" id 2.522" od	1	96-10	AE	78223-64803
D129	Ring, snap 1.765" id 2.063" od	1	96-10	AE	78223-65003
E130	Ring, snap 4.850" od	sel	96-10	AE	78223-65203
E131	Ring, snap 4.800" od (retainer type)	1	96-10	AE	78223-65503
E134	Ring, snap 1.280" id 1.508" od	1	96-10	AE	78223-65703
E135	Ring, snap	sel	96-10	AE	78223-65903
F138	Ring, snap	1	96-10	AE	78223-66203
F139	Ring, snap	1	96-10	AE	78223-66403
G144	Ring, snap	1	96-10	AE	78223-66603
G145	Ring, snap .082" 2.617" od	1	96-10	AE	78223-66803
PUMP PARTS AND PUMPS					
A148	Body, pump (w/gears)	1	96-10	AE	78223-67003
A149	Gears, pump (inner/outer)	1	96-10	AE	78223-67504
A150	Plate, pump intermediate (68 holes/bonded)	1	96-10	140-277- 4214	78223-67804
A150	Plate, pump intermediate (69 holes/bonded)	1	04-10	52108147AA	20223-68004
A151	Stator, pump	1	96-10	AE	78223-68203
A151	Stator, pump	1	04-10	AE	20223-68603
A152	Shaft, stator	1	96-10	AE	78223-70503
HARD PARTS					
A153	Spring, diaphragm 5.324" id 36T	1	96-10	AE	78223-72103
B154	Housing, K1 clutch	1	96-10	Mercedes	78223-72303
B154	Housing, K1 clutch 58T	1	96-10	AE	78223-72403
B154	Housing, K1 clutch	1	04-10	Dodge	20223-72603
B155	Piston, K1 clutch	1	96-10	AE	78223-72803
B156	Spring, diaphragm 4.958" od 10T internal	1	96-10	AE	78223-73003
B157	Retainer, K1 clutch	1	96-10	AE	78223-73203
B158	Shell, drive	1	96-10	Mercedes	78223-73403
B158	Shell, drive	1	04-10	Dodge	20223-73703
B159	Planetary, front (16T pinions)	1	96-10	Mercedes	78223-73903
B159	Planetary, front	1	04-10	Dodge	20223-74103
C160	Housing, K2 clutch	1	96-10	Mercedes	78223-74303
C160	Housing, K2 clutch	1	96-10	Mercedes	78223-74403
C160	Housing, K2 clutch	1	96-10	Mercedes	78223-74503
C160	Housing, K2 clutch (ring gear 92T)	1	04-10	Dodge	20223-74703
C161	Piston, K2 clutch	1	96-10	AE	78223-75003
C162	Spring, diaphragm 4.540" od	1	96-10	AE	78223-75203
C163	Retainer, K2 clutch	1	96-10	AE	78223-75403
C164	Gear, ring 5.480" id 7.250" od 103T id	1	96-10	AE	78223-75603
C164	Gear, ring 90T	1	96-10	Mercedes	78223-75703
C164	Gear, ring 108T	1	04-10	Dodge	20223-76003
D165	Planetary, middle 13 7/8" oh 30 spl 18T pn	1	96-10	Mercedes	78223-76303
D165	Planetary, middle (center)	1	04-10	Dodge	20223-76603

ILL	DESCRIPTION	QTY	YEAR	REFERENCE #	PART #
HARD PARTS (CONTINUED)					
D166	Gear, ring 69T 722.6 (middle planetary)	1	96-10	Mercedes	78223-77003
D166	Gear, ring 1.160" 4.990" od 70T 722.6 (middle planetary)	1	04-10	AE	78223-77303
D166	Gear, ring 74T 722.6 (middle planetary)	1	04-10	Dodge	20223-77503
D167	Planetary, rear (3 pinion gears) 722.6	1	96-10	Mercedes	78223-77703
D167	Planetary, rear (4 pinion gears) 722.6	1	04-10	Dodge	20223-77903
D168	Gear, sun middle .936" 2.226" od 34T 722.6	1	96-10	Mercedes	78223-78103
D168	Gear, sun middle 30T 722.6	1	04-10	Dodge	20223-78503
D169	Gear, sun rear 54T 722.6	1	96-10	Mercedes	78223-78703
D169	Gear, sun rear 60T 722.6	1	04-10	Dodge	20223-78903
D169	Gear, sun rear 3.588" od 65T 722.6 (.905")	1	96-10	AE	78223-79003
E172	Spring, diaphragm K3 clutch return spring	1	96-10	AE	78223-79203
E173	Piston, K3 clutch 722.6	1	96-10	AE	78223-79403
E175	Housing, K3 clutch 722.6 (3 clutch)	1	96-10	Mercedes	78223-79603
E175	Housing, K3 clutch 722.6 (4 clutch)	1	04-10	Dodge	20223-79803
E176	Retainer, B2 clutch 722.6	1	96-10	AE	78223-80003
F177	Spring, diaphragm 4.566" od 20T internal B2 clutch return spring	1	96-10	AE	78223-80203
F178	Piston, B2 clutch 722.6	1	96-10	AE	78223-80403
F179	Piston, B2 clutch 722.6	1	96-10	AE	78223-80603
F180	Housing, B2 clutch 3.495" oh 722.6	1	96-10	Mercedes	78223-80803
F180	Housing, B2 clutch 3.180" oh 722.6	1	04-10	Dodge	20223-81003
F181	Support, rear 722.6	1	96-10	AE	78223-81203
F182	Gear, park 722.6	1	96-10	AE	78223-81503
G184	Housing, bell 722.6	1	96-10	AE	78223-81703
G185	Case 722.6	1	96-10	AE	78223-82003
G186	Lever, shift shaft 722.6	1	96-10	AE	78223-82503
G187	Guide, park pawl actuator 722.6	1	96-10	AE	78223-82903
G188	Pawl, park 722.6	1	96-10	AE	78223-83103
G189	Pin, park pawl 722.6	1	96-10	AE	78223-83303
G190	Housing, extension (adapter) 4x4 722.6 (4x4/AWD)	1	04-10	AE	78223-83504
G192	Yoke, rear 2x4 722.6	1	96-10	AE	78223-83603
G193	Nut, output shaft 722.6	1	96-10	AE	78223-83803
G194	Pan 722.6	1	96-10	AE	78223-84003
G195	Valve body 722.6	1	96-10	AE	78223-84203
G196	Rod, park 722.6	1	96-10	AE	78223-84403
G197	Rooster, comb (detent plate) 722.6	1	96-10	AE	78223-84603
G198	Linkage 722.6	1	96-10	AE	78223-84803
G199	Bracket, solenoid 722.6	3	96-10	AE	78223-84903
ELECTRICAL COMPONENTS					
H205	Switch, neutral start 722.6	1	04-10	AE	78223-85504
H206	Solenoid (PWM) 722.6/W5A580 (lock-up/TCC)	1	96-10	52108314AA	78223-86004
H207	Solenoid 722.6 (2-3 shift)	1	96-10	5134760AA	78223-86404
H208	Solenoid 722.6 (modulating pressure regulating)	1	96-10	5138838AA	78223-87204
H209	Solenoid 722.6 (shift pressure regulating)	1	96-10	5138838AA	78223-87204
H210	Solenoid 722.6 (1-2/4-5 shift)	1	96-10	5134760AA	78223-86404
H211	Solenoid 722.6 (3-4 shift)	1	96-10	5134760AA	78223-86404
H212	Plate, solenoid 722.6 (electric control module)	1	96-10	140-270-0861	78223-87404
H214	Connector, case 722.6	1	96-10	203-540-0053	78223-88004

SPEEDOMETER PROBLEMS

Speedometer slow (on dash) head

- (1) Increase teeth on drive gear
- (2) Decrease teeth on driven gear

Speedometer fast (on dash) head

- (1) Decrease teeth on drive gear
- (2) Increase teeth on driven gear

Usually, there is a 3 to 5 mph change in each tooth.

The drive gear is on the output shaft on most RWD vehicles.
The driven gear is usually in the extension housing.

Most GM vehicles have both replaceable drive and driven gears. Most Ford and Chrysler vehicles have their drive gears cut into output shafts (which do come in different tooth counts). Only driven gears can be replaced without removal of output shafts. This applies to most Ford and Chrysler RWD automatics and standards.

Most Conventional 4x4's are driven at the transfer case.

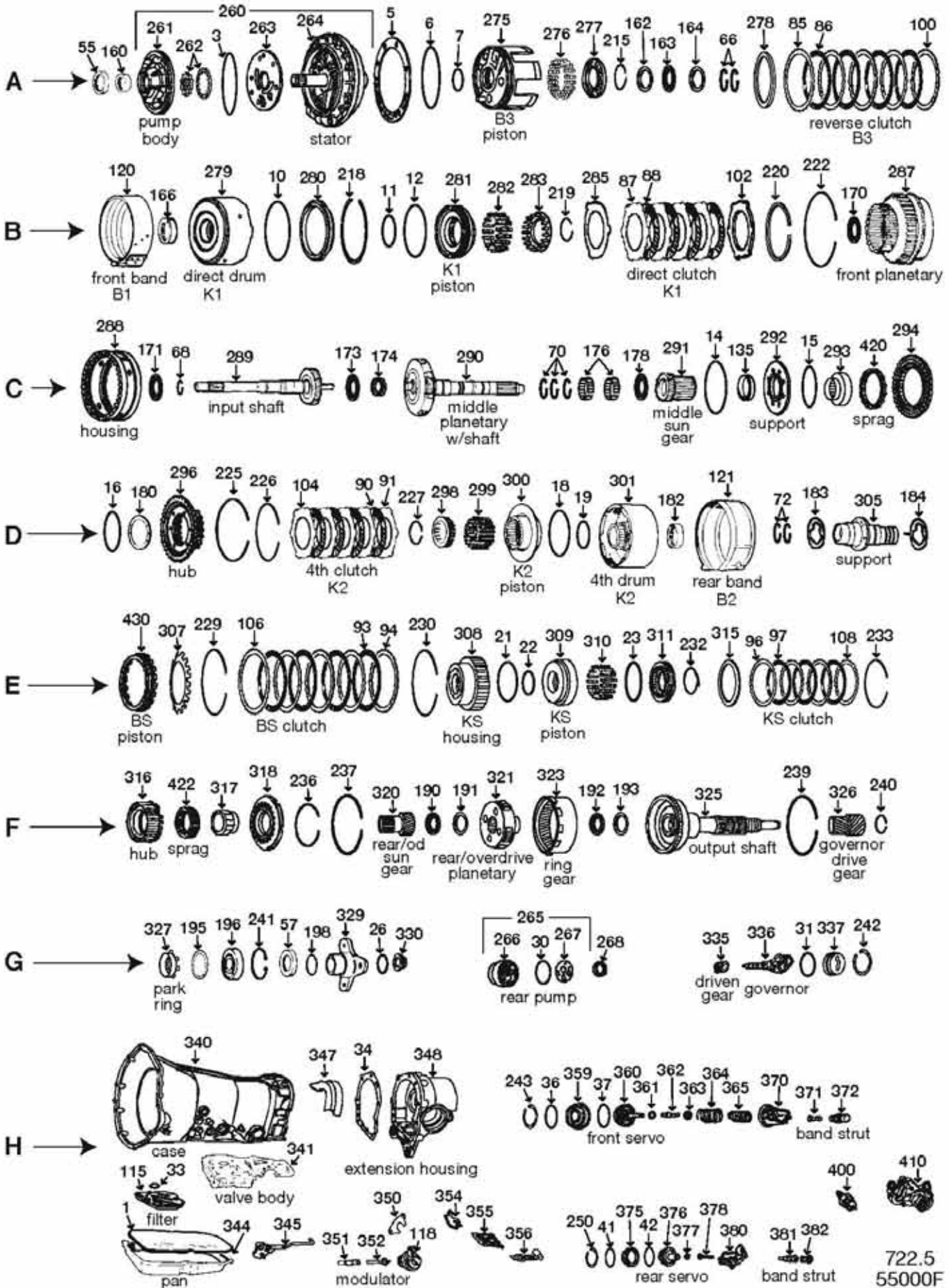

722.5
55000F

ILL	DESCRIPTION		QTY	YEAR	REFERENCE #	PART #
TECHNICAL MANUALS						
K53	Tech manual-covers 722.5 dis/assembly	diagnosis & troubleshooting	1	90-97	83-7225TM	010-451
REBUILDER KITS						
K5	Master kit w/steels-300SE and SL	722.5	1	90-97	AE	K5500F
K6	Master kit w/o steels-300SE and SL	722.5	1	90-97	AE	K5500F-LS
K7	O/H gasket set w/seals-rings-300SE and SL	722.5	1	90-97	AE	K55900F
GASKETS AND RUBBER COMPONENTS						
H1	Gasket, molded rubber	722.5	1	90-97	126-271-0280	13841R
METAL CLAD SEALS						
A55	Seal, metal clad	front	1	90-97	010-997-5049	55206
G57	Seal, metal clad	extension housing	1	90-97	008-997-6647	22978
n/i	Seal, metal clad	shift shaft	1	90-97	006-997-0147	55210
n/i	Seal, metal clad	rear servo	1	90-97	006-997-7347	55212
CLUTCH PLATES						
A85	Steel .091" 5.787" id 36T	reverse clutch (B-3)	sel	90-97	126-272-6726	55117
A85	Steel .110" 5.787" id 36T	reverse clutch (B-3)	sel	90-97	126-272-6826	55117A
A85	Steel .130" 5.787" id 36T	reverse clutch (B-3)	sel	90-97	126-272-6426	55117B
A85	Steel .150" 5.787" id 36T	reverse clutch (B-3)	sel	90-97	126-272-6526	55117C
A86	Friction .081" 6.678" od 36T	reverse clutch (B-3)	4/5	90-97	126-272-0925	55104
B87	Steel .079" 4.094" id 6T	direct clutch (K-1)	sel	90-97	126-272-0926	55115
B87	Steel .138" 4.094" id 6T	direct clutch (K-1)	sel	90-97	126-272-1006	55115B
B87	Steel .157" 4.094" id 6T	direct clutch (K-1)	sel	90-97	126-272-1126	55115C
B87	Steel .177" 4.094" id 6T	direct clutch (K-1)	sel	90-97	126-272-1226	55115D
B87	Steel .197" 4.094" id 6T	direct clutch (K-1)	sel	90-97	126-272-1326	55115E
B87	Steel .217" 4.094" id 6T	direct clutch (K-1)	sel	90-97	126-272-1426	55115F
B88	Friction .083" 5.265" od 24T	direct clutch (K-1)	4/5	90-97	126-272-0625	55103
D90	Friction .085" 4.870" od 24T	4th clutch (K-2)	4/5	90-97	126-272-0325	55102
D91	Steel .079" 3.464" id 6T	4th clutch (K-2)	sel	90-97	126-272-0326	55116
D91	Steel .118" 3.464" id 6T	4th clutch (K-2)	sel	90-97	126-272-0426	55116A
D91	Steel .138" 3.464" id 6T	4th clutch (K-2)	sel	90-97	126-272-0526	55116B
D91	Steel .177" 3.464" id 6T	4th clutch (K-2)	sel	90-97	126-272-0626	55116D
D91	Steel .197" 3.464" id 6T	4th clutch (K-2)	sel	90-97	126-272-0726	55116E
D91	Steel .217" 3.464" id 6T	4th clutch (K-2)	sel	90-97	126-272-0826	55116F
E93	Friction .084" 5.500" od 28T	overdrive clutch (BS)	4	90-97	124-272-0025	55109
E94	Steel .098" 4.786" id 8T	overdrive clutch (BS)	1	90-97	129-272-0126	55133
E94	Steel .215" 4.786" id 8T	overdrive clutch (BS)	3	90-97	129-272-0226	55133A
E96	Steel .079" 3.504" id 28T	overrun clutch (KS)	4	90-97	124-272-0226	55131
E96	Steel .138" 3.504" id 28T	overrun clutch (KS)	sel	90-97	124-272-0326	55131A
E97	Friction .084" 4.180" od 22T	overrun clutch (KS)	4	90-97	124-272-0125	55132
PRESSURE PLATES						
A100	Pressure plate .303" 5.79" id 36T	reverse clutch (B-3)	sel	90-97	126-272-6926	55117D
FILTERS						
K9	Kit, filter	722.5	1	90-97	AE	FK55800F
H115	Filter, oil	722.5	1	90-97	129-277-0195	55800F
MODULATORS						
H118	Modulator, vacuum-black or blue	722.5	1	90-97	126-270-9179	55820G
BANDS						
B12	Band, intermediate	front	1	90-97	126-270-1862	55700
D121	Band, rear	722.5	1	90-97	126-270-2062	55701
ELECTRICAL COMPONENTS						
n/i	Solenoid	shift	1	90-97	n/a	5A-505
NOTES						

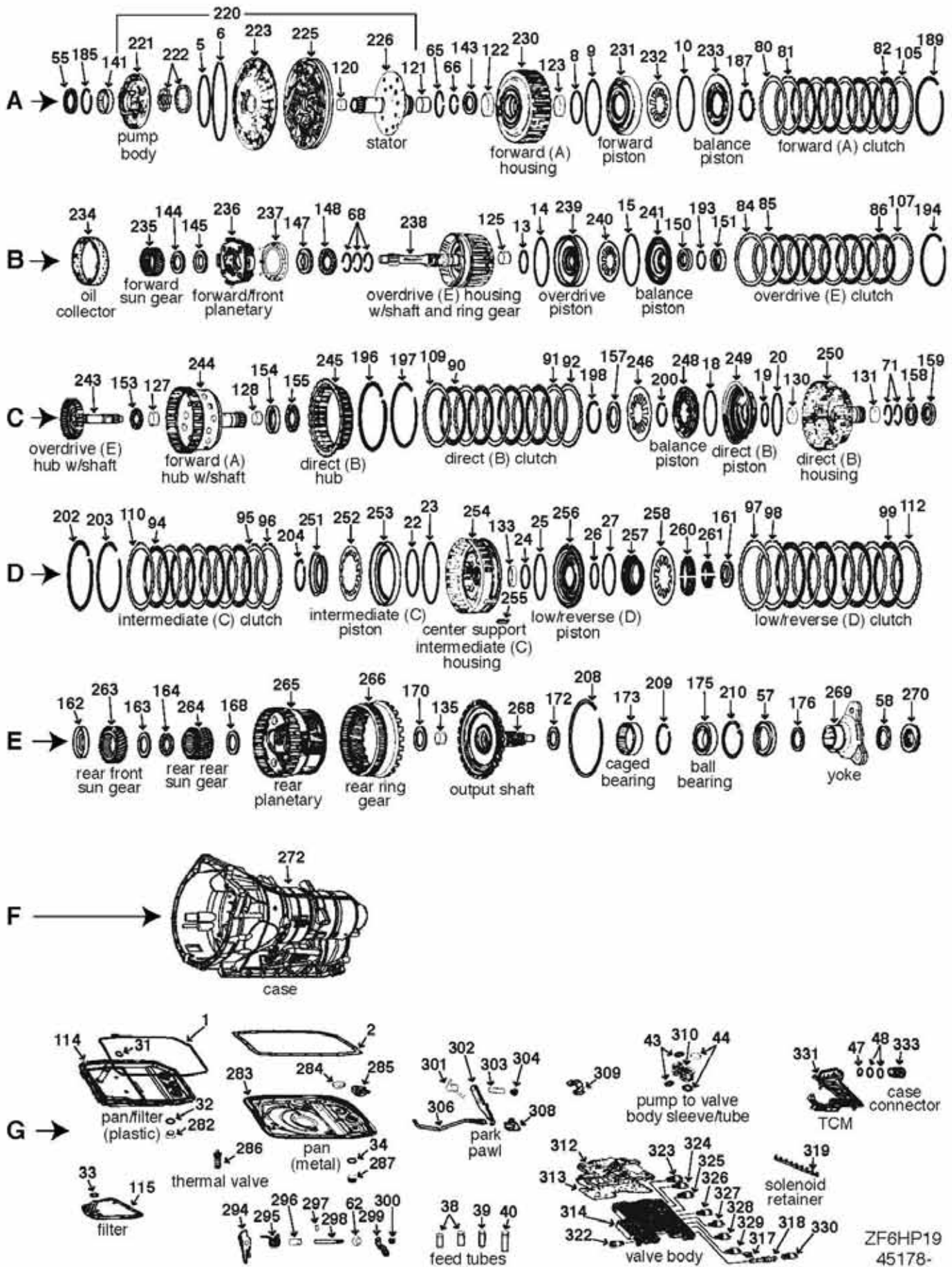

ZF6HP19
45178-

ILL	DESCRIPTION	QTY	YEAR	REFERENCE #	PART #
REBUILDER KITS					
K5	Master kit w/steels w/pistons	1	04-09	APC-143901	45178-11004
K5	Master kit w/steels w/o pistons	1	04-09	APC-143901X	45178-11104
K6	Master kit w/o steels w/pistons	1	04-09	APC-143901LS	45178-12004
K6	Master kit w/o steels w/o pistons	1	04-09	APC-143901XLS	45178-12104
K7	O/H gasket set w/seals-rings w/o pistons	1	04-09	APC-143800X	45178-13104
K7	O/H gasket set w/seals-rings w/pistons	1	04-09	APC-143800	45178-13004
GASKETS AND RUBBER COMPONENTS					
G1	Gasket, oil pan (w/molded rubber edge) ZF6HP19	1	04-09	n/a	15158-20104
G2	Gasket, oil pan ZF6HP19	1	04-09	n/a	45158-20104
METAL CLAD SEALS					
A55	Seal, metal clad front	1	04-09	n/a	45178-30104
E57	Seal, metal clad extension housing	1	04-09	n/a	45178-30204
G62	Seal, metal clad shift shaft	1	04-09	n/a	45178-30504
SEALING RINGS					
K10	Kit, sealing ring ZF6HP19	1	04-09	n/a	45178-31504
CLUTCH PLATES					
A80	Steel 6.050" id 30T (waved) (A) forward clutch	1	04-09	n/a	45178-37504
A81	Steel .118" 6.050" id 30T (A) forward clutch	4	04-09	APC-143701-300	45178-37604
A82	Friction .064" 6.650" od 30T (A) forward clutch	4	04-09	APC-143700-163	45178-35204
B84	Steel 3.820" id 24T (waved) (E) overdrive clutch	1	04-09	n/a	45178-37704
B85	Steel .082" 3.820" id 24T (E) overdrive clutch	4	04-09	APC-143707-208	45178-37804
B86	Friction .063" 4.880" od 30T (E) overdrive clutch	4	04-09	APC-143706-160	45178-35404
C90	Friction .085" 6.650" od 30T (B) direct clutch	5	04-09	APC-143700-216	45178-35604
C91	Steel .094" 6.050" id 30T (B) direct clutch	4	04-09	APC-143701-240	45178-38104
C92	Steel 6.050" id 30T (waved) (B) direct clutch	1	04-09	n/a	45178-38204
D94	Friction .063" 6.100" od 24T (C) intermediate clutch	4	04-09	APC-143702-160	45178-35904
D94	Steel .098" 4.680" id 24T (C) intermediate clutch	4	04-09	APC-143703-250	45178-38404
D96	Steel 4.680" id 24T (waved) (C) intermediate clutch	1	04-09	n/a	45178-38504
D97	Steel 5.080" id 24T (waved) (D) low/reverse clutch	1	04-09	n/a	45178-38704
D98	Steel .071" 5.080" id 24T (D) low/reverse clutch	4	04-09	APC-143705	45178-38804
D99	Friction .0632" 5.940" od 30T (D) low/reverse clutch	5	04-09	APC-143704-157	45178-36204
PRESSURE PLATES					
A105	Pressure plate (A) forward clutch	1	04-09	AE	45178-41103
B107	Pressure plate (E) overdrive clutch	1	04-09	AE	45178-41303
C109	Pressure plate (B) direct clutch	1	04-09	AE	45178-41603
D110	Pressure plate (C) intermediate clutch	1	04-09	AE	45178-41903
D112	Pressure plate (D) low/reverse clutch	1	04-09	AE	45178-42303
FILTERS					
G114	Filter, oil screen/pan assembly ZF6HP19	1	04-09	n/a	45158-45004
G33	Filter (6 sided not equal) ZF6HP19	1	04-09	n/a	15158-45104
PUMP PARTS AND PUMPS					
A220	Pump assembly ZF6HP19	1	04-09	AE	45178-67003
HARD PARTS					
F272	Housing, case ZF6HP19	1	04-09	AE	45178-78503
G283	Pan metal ZF6HP19	1	04-09	AE	15158-82904
G314	Valve body w/solenoids ZF6HP19	1	04-09	AE	45178-80503
NOTES					

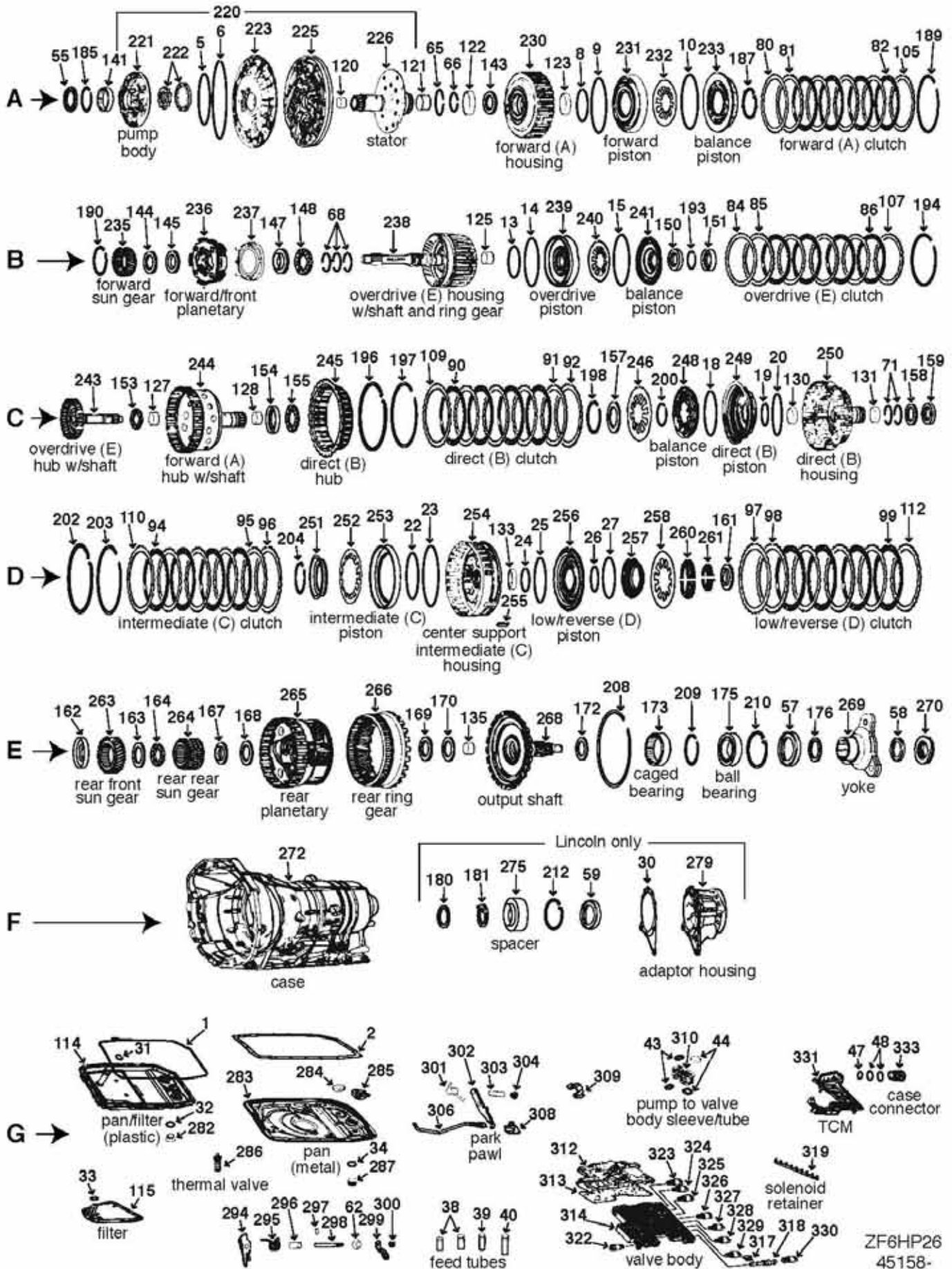

ZF6HP26
45158-

ILL	DESCRIPTION		QTY	YEAR	REFERENCE #	PART #
TECHNICAL MANUALS						
K53	Tech manual 6R60/ZF6HP26 dis/assembly	diagnosis & troubleshooting	1	02-11	ZF6HP26TM	010-232
REBUILDER KITS						
K5	Master kit w/steels	w/o bonded separator plate	1	02-11	AE	45158-11104
K6	Master kit w/o steels	w/o bonded separator plate	1	02-11	AE	45158-12104
K7	O/H gasket set w/seals-rings	w/o bonded separator plate	1	02-11	FDB-2496	45158-13104
VALVE BODY KITS						
K15	Kit, valve body repair	ZF6HP26	1	04-11	n/a	15158-17009
K15	Kit, valve body repair	ZF6HP26	1	04-11	n/a	15158-17005
GASKETS AND RUBBER COMPONENTS						
G1	Gasket, oil pan	molded rubber for plastic pan	1	01-10	0501-323-155	45158-20104
G2	Gasket, oil pan (w/molded rubber edge)	ZF6HP26	1	02-11	FDB-B33324	15158-20104
A5	O'ring	pump body	1	02-11	MGW-86154	15158-21004
A6	O'ring	pump plate	1	02-11	6L2Z-7A248-CA	15158-21204
G38	Seal, rubber tube 1.000" length	intermediate housing to valve body	2	02-11	n/a	15158-23504
G39	Seal, rubber tube 1.212" length	intermediate housing to valve body	1	02-11	n/a	15158-23604
G40	Seal, rubber tube 1.565" length	intermediate housing to valve body	1	02-11	n/a	15158-23704
G43	Seal, rubber (small)	VB to sleeve/tube (plastic) to ump	2	02-11	FDB-B33328	15158-23804
G44	Seal, rubber (large)	VB to sleeve/tube (plastic) to ump	2	02-11	FDB-B33327	15158-23904
G47	O'ring	electrical connector to valve body	1	02-11	n/a	15158-24104
G48	O'ring	electrical connector to case	2	02-11	FDB-B16216	15158-24204
n/i	Washer, pump bolt (rubber inner)	ZF6HP26A	14	02-11	n/a	15158-21104
G62	Seal, metal clad	shift shaft	1	02-11	6L2Z-7B498-AA	15158-30604
METAL CLAD SEALS						
A55	Seal, metal clad	front	1	02-11	6L2Z-7A248-AA	15158-30004
E57	Seal, metal clad	extension housing (2WD)	1	02-08	6L2Z-7052-AA	15158-30104
E57	Seal, metal clad	extension housing (2WD)	1	08-11	9L3Z-7052-A	15158-30114
E58	Seal, rubber	yoke (2WD)	1	02-11	6L2Z-7052-A	15158-30804
SEALING RINGS						
K10	Kit, sealing ring	ZF6HP26	1	02-11	FDB-3501	15158-31504
A65	Ring, sealing (metal)	pump stator	1	02-11	6L2Z-7D019-AA	15158-32004
A66	Ring, sealing (metal)	pump stator	1	02-11	6L2Z-7L323-AA	15158-32304
B68	Ring, sealing (plastic)	turbine shaft (overdrive housing)	3	02-11	n/a	15158-33204
B68	Ring, sealing (teflon)	turbine shaft (overdrive housing)	2	02-11	6L2Z-7G091-DA	15158-33304
C71	Ring, sealing (teflon)	direct clutch housing	2	02-11	6L2Z-7D020-CA	15158-33504
CLUTCH PLATES						
A80	Steel .035" 6.450" id 30T (waved plate)	(A) forward clutch	1	02-11	n/a	15158-37704
A81	Steel .118" 6.450" id 30T	(A) forward clutch	4/5	02-11	1068-377-020	15158-37504
A81	Steel .105" 6.450" id 30T	(A) forward clutch	sel	02-11	1068-377-023	15158-38304
A81	Steel .130" 6.450" id 30T	(A) forward clutch	sel	02-11	1068-377-024	15158-38404
A81	Steel .142" 6.450" id 30T	(A) forward clutch	sel	02-11	1068-377-025	15158-38504
A82	Friction .063" 7.370" od 30T	(A) forward clutch	4/5	02-11	1068-277-004	15158-35204
B84	Steel .030" 4.200" id 24T (waved plate)	(E) overdrive clutch	1	02-11	n/a	15158-37804
B85	Steel .118" 4.200" id 24T	(E) overdrive clutch	6/7	02-11	1068-371-030	15158-38004
B85	Steel .095" 4.200" id 24T	(E) overdrive clutch (some models)	6/7	02-11	APC-183703-240	15158-38104
B86	Friction .063" 5.150" od 30T	(E) overdrive clutch	6	02-11	n/a	15158-35604
B86	Friction .079" 5.150" od 30T	(E) overdrive clutch	sel	02-11	APC-183702-200	15158-35704
C90	Friction .087" 7.370" od 30T	(B) direct clutch	4/5	02-11	1068-277-002	15158-35304
C91	Steel .082" 6.450" id 30T	(B) direct clutch	4/5	01-11	1068-377-019	15158-37604
C92	Steel .035" 6.450" id 30T (waved plate)	(B) direct clutch	1	02-11	n/a	15158-37704
D94	Friction .087" 7.370" od 30T	(C) intermediate clutch	4/5	02-11	1068-277-002	15158-35304
D95	Steel .118" 6.450" id 30T	(C) intermediate clutch	4/5	02-11	1068-377-020	15158-37504
D96	Steel .035" 6.450" id 30T (waved plate)	(C) intermediate clutch	1	02-11	n/a	15158-37704
D97	Steel .040" 6.450" id 30T (waved plate)	(D) low/reverse clutch	1	02-11	n/a	15158-37904

ZF6HP26

ZF6HP26

ILL	DESCRIPTION	QTY	YEAR	REFERENCE #	PART #
CLUTCH PLATES (CONTINUED)					
D98	Steel .082" 6.450" id 30T (D) low/reverse clutch	6/7	02-11	1068-377-019	15158-37604
D98	Steel .095" 6.450" id 30T (D) low/reverse clutch	sel	02-11	1068-377-022	15158-38204
D99	Friction .063" 7.370" od 30T (D) low/reverse clutch	6/7	02-11	1068-277-004	15158-35204
PRESSURE PLATES					
A105	Pressure plate .105" 6.450" id 30T (A) forward clutch	1	02-11	AE	15158-41103
B107	Pressure plate .118" 4.200" id 24T/24 tabs (E) overdrive clutch	1	02-11	AE	15158-41603
C109	Pressure plate .152" 6.450" 30T/30 tabs (B) direct clutch	1	02-11	AE	15158-42003
D110	Pressure plate 30T (C) intermediate clutch	1	02-11	AE	15158-42203
D112	Pressure plate .142" 6.450" 30T (D) low reverse clutch	1	02-11	AE	15158-43003
D112	Pressure plate .130" 6.450" 30T (D) low reverse clutch	sel	02-11	AE	15158-42303
D112	Pressure plate .095" 6.450" 30T (D) low reverse clutch	sel	02-11	AE	15158-42503
FILTERS					
G115	Filter (6 sided not equal) ZF6HP26	1	01-10	0501-213-359	15158-45104
G114	Filter, oil screen/pan assembly plastic pan w/filter made in it	1	97-04	0501-216-243	45158-45004
BUSHINGS					
K12	Kit, bushing ZF6HP26	1	02-11	n/a	15158-50004
A120	Bushing stator (front)	1	02-11	n/a	15158-50704
A121	Bushing stator (rear)	1	02-11	n/a	15158-50804
A122	Bushing forward housing (front)	1	02-11	n/a	15158-50904
A123	Bushing forward housing (rear)	1	02-11	n/a	15158-51204
B125	Bushing overdrive housing (rear)	1	02-11	n/a	15158-51404
C127	Bushing forward hub (front)	1	02-11	n/a	15158-51604
C128	Bushing forward hub (rear)	1	02-11	n/a	15158-51604
C130	Bushing direct housing (front)	1	02-11	n/a	15158-52204
C131	Bushing direct housing (rear)	1	02-11	n/a	15158-52204
D133	Bushing intermediate clutch housing (center)	1	02-11	n/a	15158-52304
E135	Bushing output shaft (front)	1	02-11	n/a	15158-52504
WASHERS/BEARINGS/RACES/SHIMS					
K12	Kit, thrust bearing ZF6HP26	1	02-11	n/a	15158-55104
A141	Bearing, caged pump body	1	02-11	n/a	15158-56104
A143	Spacer, shim .133" 1.596" id 1.928" od pump stator to front sun gear	sel	02-11	n/a	15158-56204
B144	Bearing, thrust .161" 1.381" id 2.037" od sun gear to race	1	02-11	n/a	15158-56504
B145	Race, thrust .038" 1.303" id 1.905" od bearing to forward planetary	1	02-11	n/a	15158-56604
B147	Race, thrust .030" 1.367" id 1.904" od forward planetary to bearing	1	02-11	n/a	15158-57004
B148	Bearing, thrust .161" 1.381" id 2.037" od race to overdrive housing	1	02-11	n/a	15158-56504
B150	Washer (retainer) .043" 1.38" id 1.702" od od bal piston to snap ring	1	02-11	n/a	15158-57504
B151	Bearing, thrust .185" .834" id 1.504" od overdrive housing to od hub	1	02-11	n/a	15158-57804
C153	Bearing, thrust .161" 1.381" id 2.037" od overdrive hub to forward hub	1	02-11	n/a	15158-56504
C154	Race .038" 1.441" id 2.209" od forward hub to bearing	1	02-11	n/a	15158-58304
C155	Bearing, thrust .155" 1.384" id 2.254" od race to direct housing	1	02-11	n/a	15158-58504
C157	Washer (retainer) .080" 1.97" id 2.34" od snap ring to diaphragm spring	1	02-11	n/a	15158-58804
C158	Bearing, thrust .135" 1.930" id 2.628" od direct housing to race	1	02-11	n/a	15158-59004
C159	Race .032" 2.073" id 2.622" od bearing to intermediate housing	1	02-11	n/a	15158-59204
D161	Bearing, thrust .136" 1.860" id 2.670" od intermediate housing to race	1	02-11	n/a	15158-59604
D162	Race .042" 2.003" id 2.819" od bearing to sun gear	1	02-11	n/a	15158-59704
E163	Race .125" 1.380" id 1.970" od rear (front) sun gear to bearing	1	02-11	n/a	15158-60104
E164	Bearing, thrust .0154" 1.342" id 2.046" od race to rear sun gear	1	02-11	n/a	15158-60504
E167	Bearing, thrust .0154" 1.342" id 2.046" od race to rear sun gear	1	02-11	n/a	15158-60504
E168	Race .038" 1.333" id 1.902" od bearing to rear planetary	1	02-11	n/a	15158-60604
E169	Bearing, thrust .155" 1.579" id 2.187" od rear planetary to output shaft	1	02-11	n/a	15158-60904
E170	Race .038" 1.701" id 2.321" od rear planetary to output shaft	1	02-11	n/a	15158-61004
E172	Washer, spacer .071" 1.549" id 2.160" od output shaft yoke (2WD)	1	02-11	sel	15158-61204
E173	Bearing, caged in rear of case	1	02-11	F-233285-1	15158-61504

ILL	DESCRIPTION	QTY	YEAR	REFERENCE #	PART #	
WASHERS/BEARINGS/RACES/SHIMS (CONTINUED)						
F180	Washer, spacer .071" 1.549" id 2.160" od	output shaft to bearing	1	02-11	sel	15158-61204
F181	Bearing, thrust .197" 1.565" id 2.315" od	output shaft to sleeve	1	02-11	n/a	15158-62004
SNAP RINGS						
A187	Snap ring .056" 3.0" od 4 tabs (true-arc)	fwd balance piston to diaphragm spring	1	02-11	AE	15158-62303
A189	Snap ring .155" 7.783" od	forward clutch pressure plate	1	02-11	AE	15158-62503
B190	Snap ring .038" 2.900" (waved)	forward hsg to forward/front planetary	1	02-11	AE	15158-62903
B193	Snap ring .095" 1.633" od	od balance piston retainer to od hsg	1	02-11	AE	15158-63303
B194	Snap ring .083" 5.584" od	overdrive clutch pressure plate	1	02-11	AE	15158-63603
C196	Snap ring .099" 7.750" od	direct hub to forward housing	1	02-11	AE	15158-63803
C197	Snap ring .138" 7.750" od	direct clutch pressure plate	1	02-11	AE	15158-64203
C198	Snap ring .056" 2.250" od	inside direct balance piston	1	02-11	AE	15158-64603
C200	Snap ring .096" 2.130" od	direct balance piston to diaphragm spring	1	02-11	AE	15158-64803
D202	Snap ring .181" (beveled both sides)	8.500" od (intermediate housing to case)	1	02-11	AE	15158-65103
D203	Snap ring .123" 7.750" od	intermediate clutch pressure plate	1	02-11	AE	15158-65403
D204	Snap ring .075" 3.700" od	intermediate clutch retainer	1	02-11	AE	15158-65703
E208	Snap ring .076" 7.250" od	output shaft to rear ring gear	1	02-11	AE	15158-66003
E209	Snap ring	caged bearing to ball bearing (2WD)	1	02-11	AE	15158-66203
E210	Snap ring .096" (beveled both sides)	3.0662" od (ball bearing to case 2WD)	1	02-11	AE	15158-66503
F212	Snap ring .096" (beveled both sides)	3.0662" od (spacer to case 4WD)	1	02-11	AE	15158-66503
PUMP PARTS AND PUMPS						
A220	Pump, assembly (w/o front bushing)	1.000" id rear bushing	1	02-11	AE	15158-67003
A220	Pump, assembly (w/o front bushing)	1.180" id rear bushing	1	02-11	AE	15158-67103
A220	Plate, pump	1.180" id rear bushing	1	02-11	AE	15158-70203
A221	Pump body w/gears	vent hole 1.190" od	1	02-11	AE	15158-67503
A221	Pump body w/gears	vent hole .265" od	1	02-11	AE	15158-67603
A222	Gears, pump .550" thickness 3.767" od	17T inner gear 21T outer gear	1	02-11	n/a	15158-68104
A223	Plate, pump	pump body sits in	1	02-11	AE	15158-70003
A223	Plate, pump	pump body sits in	1	02-11	AE	15158-70103
A223	Plate, pump	pump body sits in	1	02-11	AE	15158-70203
A225	Plate, pump channel	between pump plate and stator support	1	02-11	AE	15158-70503
A225	Plate, pump channel	between pump plate and stator support	1	02-11	AE	15158-70603
A226	Support, pump stator (w/o front bushing)	1.000" id rear bushing	1	02-11	AE	15158-68403
A226	Support, pump stator (w/o front bushing)	1.180" id rear bushing	1	02-11	AE	15158-68503
A226	Support, pump stator (w/front bushing)	1.180" id rear bushing	1	02-11	AE	15158-68603
HARD PARTS						
A230	Housing, forward clutch	casting #1068-102-358/0247686-1	1	02-11	AE	15158-72203
A231	Piston, forward clutch 1.485" oh	casting #1068-470-044	1	02-11	AE	15158-72503
A231	Piston, forward clutch	ZF6HP26	1	02-11	AE	15158-72603
A232	Spring, diaphragm .082" 10 fingers	forward clutch (5.633" od)	1	02-11	AE	15158-72803
A233	Piston, forward balance	3 drive slots for 3 pinion planetary	1	02-11	AE	15158-73003
A233	Piston, forward clutch (balance)	4 drive slots for 4 pinion planetary	1	02-11	AE	15158-73203
B235	Gear, sun forward 2.567" od 37T	1 id groove	1	02-11	AE	15158-73503
B236	Planetary, forward front 3 pinion gears	3 sets 6T drive teeth	1	02-11	AE	15158-73703
G236	Planet, forward front 4 pinion gears 16T	4 sets 6T drive teeth	1	02-11	Ae	15158-73903
B237	Slinger, oil dam	4 tabs 4 oil tubes	1	02-11	1070-332-063	15158-74103
B238	Housing, od (w/turbine shaft ring gear)	bushing surface by splines 2 sealing rings	1	02-11	AE	15158-74503
B238	Housing, od (w/turbine shaft ring gear)	no bushing surface on shaft 3 seal rings	1	02-11	AE	15158-74603
B239	Piston, overdrive clutch 1.340" oh	casting #1068-471-037	1	02-11	AE	15158-75003
B240	Spring, diaphragm .079" 10 fingers	overdrive clutch (4.489" od)	1	02-11	AE	15158-75203
B241	Piston, overdrive balance	ZF6HP26	1	02-11	AE	15158-75403
C243	Hub, overdrive w/shaft	ZF6HP26	1	02-11	AE	15158-75603
C243	Hub, overdrive w/shaft .925" od 29 splines	ZF6HP26	1	02-11	AE	15158-75703
C244	Hub, forward clutch w/shaft 1.306" od	41 splines	1	02-11	AE	15158-75903

ZF6HP26

ZF6HP26

ILL	DESCRIPTION	QTY	YEAR	REFERENCE #	PART #	
HARD PARTS (CONTINUED)						
C245	Hub, direct clutch	ZF6HP26	1	02-11	AE	15158-76103
C246	Spring, diaphragm .079" 10 fingers	4.865" od	1	02-11	AE	15158-76503
C248	Piston, balance direct clutch	casting #1068-472-035	1	02-11	AE	15158-76703
C249	Piston, direct clutch	aluminum w/steel retainer (pressed on)	1	02-11	AE	15158-76903
C250	Housing, direct clutch 1.773" od	56 splines	1	02-11	AE	15158-77203
D251	Retainer, intermediate clutch	ZF6HP26	1	02-11	AE	15158-77503
C252	Spring, diaphragm .082" 6.948" od	12 fingers	1	02-11	AE	15158-77803
D253	Piston, intermediate clutch .737" oh	casting #1068-475-014	1	02-11	AE	15158-78003
D253	Piston, intermediate clutch	ZF6HP26	1	02-11	AE	15158-78203
D254	Housing, intermediate clutch	casting #1068-475-014	1	02-11	AE	15158-78503
D254	Housing, intermediate clutch	ZF6HP26	1	02-11	AE	15158-78703
D256	Piston, low/reverse clutch	E stamped on it	1	02-11	AE	15158-79003
D256	Piston, low/reverse clutch	ZF6HP26	1	02-11	AE	15158-79203
D257	Piston, balance low/reverse clutch	casting #1068-473-020	1	02-11	AE	15158-79503
D258	Spring, diaphragm .063" 12 fingers	5.694" od (low/reverse clutch)	1	02-11	AE	15158-79603
D260	Retainer, 2 piece (split type)	low/reverse (large)	1	02-11	AE	15158-79803
D261	Retainer, 2 piece (split type w/2 tabs)	low/reverse (small)	1	02-11	AE	15158-79903
E263	Gear, rear front sun gear 2.877" od 38T	3 id grooves	1	02-11	AE	15158-80103
E264	Gear, rear rear sun gear 2.373" od 31T	bevel to rear	1	02-11	AE	15158-80503
E265	Planetary, rear 23T on split pinions	24T on short pinion gears	1	02-11	AE	15158-81003
E266	Gear, output ring 85T	with 40T exciter	1	02-11	AE	15158-81503
E268	Shaft, output (w/park gear 2WD)	bolt-on yoke	1	02-11	AE	15158-82003
E268	Shaft, output direct mount	w/park gear (AWD)	1	02-11	AE	15158-82303
E268	Shaft, output direct mount 8.750" oh	w/park gear 4WD	1	02-11	AE	15158-82503
E269	Yoke, drive	3 bolt u-joint 2WD	1	02-11	AE	15158-82603
E269	Yoke, drive	4 bolt u-joint 2WD	1	02-11	AE	15158-82703
F275	Spacer, aluminum	4WD/AWD	1	02-11	AE	15158-82803
G283	Pan metal	ZF6HP26	1	02-11	AE	15158-82904
G288	Roll, detent spring	ZF6HP26	1	02-11	AE	15158-83003
G289	Cone, rooster	ZF6HP26	1	02-11	AE	15158-83103
G290	Spacer	manual lever shaft	1	02-11	AE	15158-83203
G291	Pin, roll	rooster cone lock	1	02-11	AE	15158-83304
G292	Shaft, manual lever	ZF6HP26	1	02-11	AE	15158-83404
G301	Spring, park return	ZF6HP26	1	02-11	AE	15158-83903
G302	Pawl, park	ZF6HP26	1	02-11	AE	15158-84003
G303	Pin, park shaft	ZF6HP26	1	02-11	AE	15158-84103
G304	Bolt, park pin	ZF6HP26	1	02-11	AE	15158-84203
G306	Rod, park	ZF6HP26	1	02-11	AE	15158-84303
G308	Bracket, park rod guide	ZF6HP26	1	02-11	AE	15158-84403
G310	Housing seals (plastic)	ZF6HP26 (pump to valve body)	1	02-11	AE	15158-84503
G313	Plate, valve body (bonded)	ZF6HP26	1	06-07	6L2Z-7Z490-A	15158-28804
G313	Plate, valve body (bonded)	# on plate (1068-327-180)	1	01-10	1068-227-052	45158-28904
G313	Plate, valve body (bonded)	# on plate (1068-327-141)	1	01-10	1068-227-035	45158-29004
G313	Plate, valve body (bonded)	# on plate (1068-327-179)	1	01-10	1068-227-051	45158-29104
G313	Plate, valve body (bonded)	# on plate (1068-327-163)	1	01-10	1068-227-047	45158-29204
G313	Plate, valve body (bonded)	# on plate (1068-327-189)	1	01-10	1068-227-053	45158-29304
G314	Valve body w/solenoids	ZF6HP26	1	02-11	AE	45158-84603

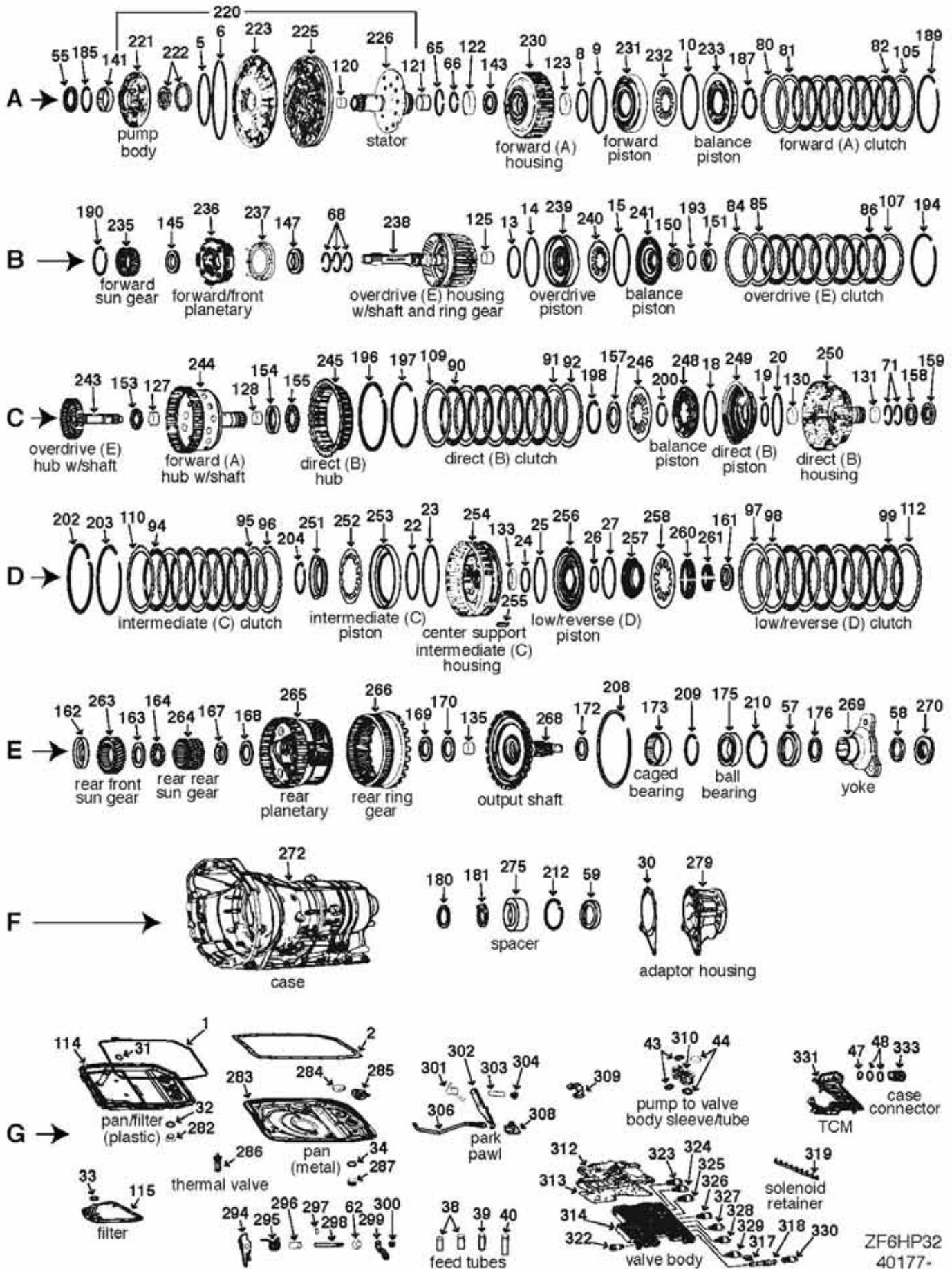

ZF6HP32
40177-

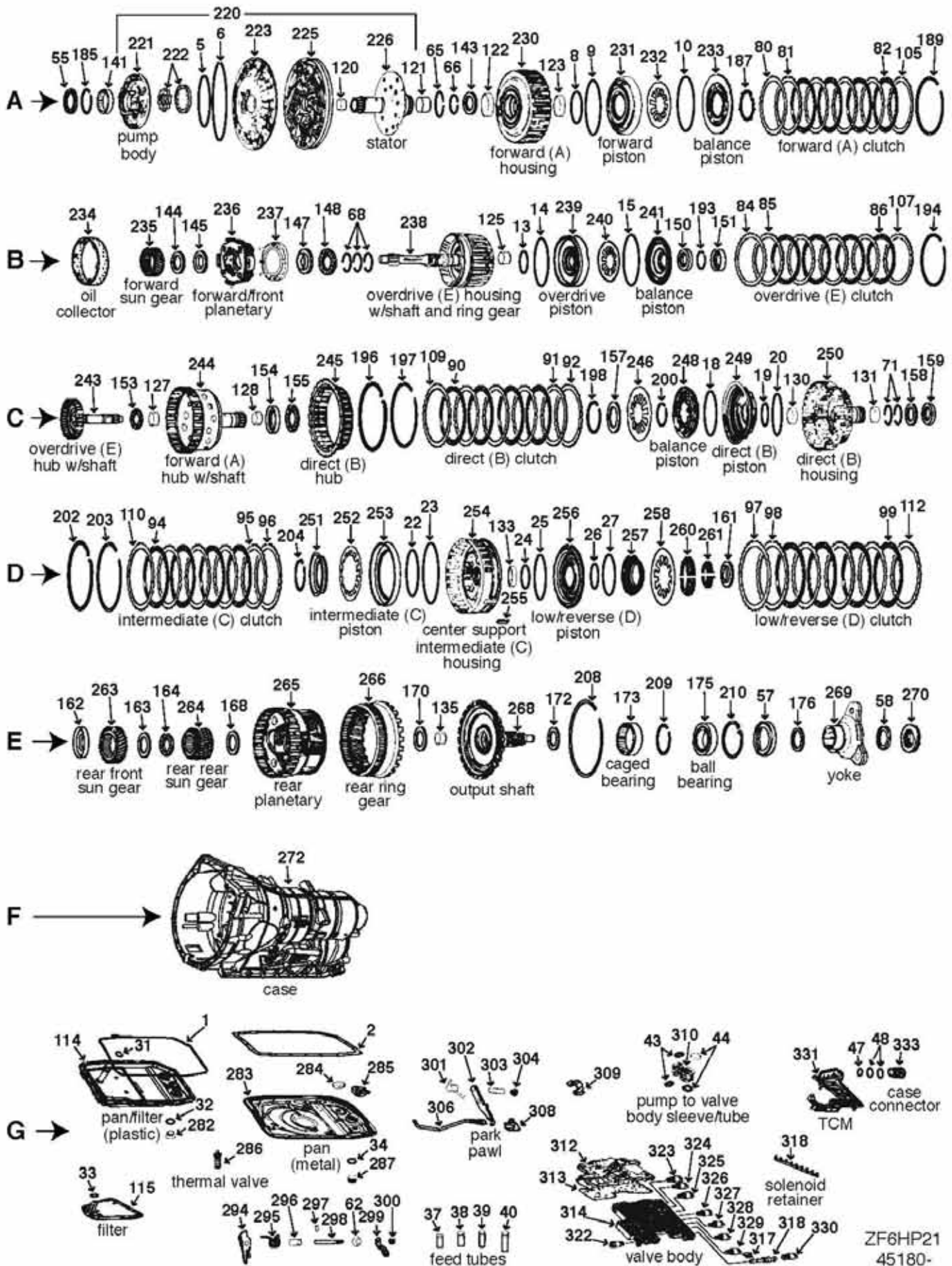

ZF6HP21
45180-

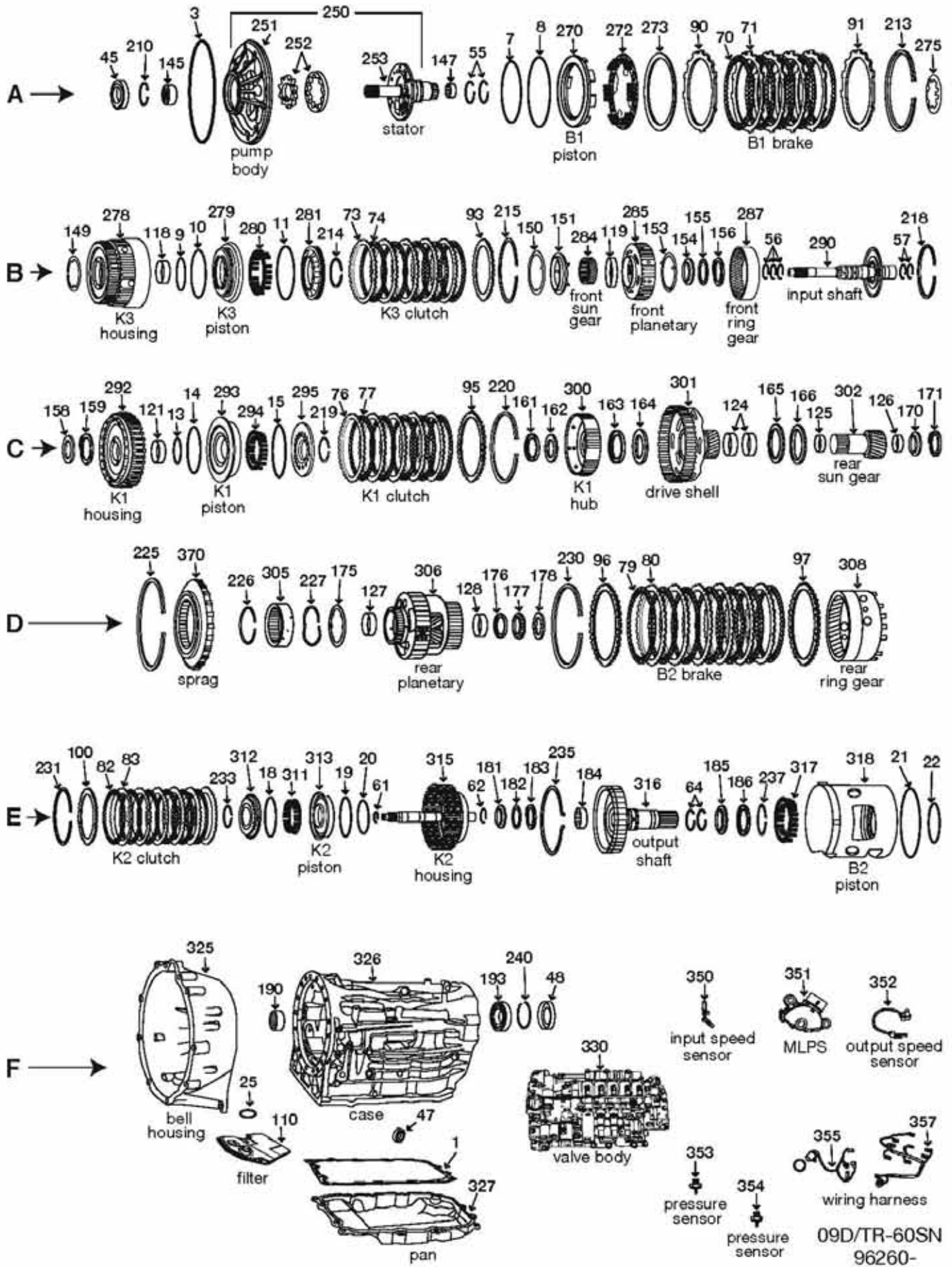

ILL	DESCRIPTION	QTY	YEAR	REFERENCE #	PART #	
REBUILDER KITS						
K5	Master kit w/steels	09D/TR60SN	1	04-11	185901	96260-11104
K6	Master kit w/o steels	09D/TR60SN	1	04-11	185901LS	96260-12104
K7	O/H gasket set w/seals-rings	09D/TR60SN	1	04-11	185800	96260-13104
GASKETS AND RUBBER COMPONENTS						
F1	Gasket, pan	09D/TR60SN	1	04-11	n/a	96260-20104
METAL CLAD SEALS						
A45	Seal, metal clad	front	1	04-11	n/a	96260-30104
F47	Seal, metal clad 12x22x7mm	shift shaft	1	04-11	90311-12002	46202
F48	Seal, metal clad	rear case seal	1	04-11	n/a	96260-30604
SEALING RINGS						
K9	Kit, sealing rings	09D/TR60SN	1	04-11	n/a	96260-31504
A55	Sealing ring (teflon)	pump support	2	04-11	n/a	96260-33104
B56	Sealing ring (teflon)	input shaft (front)	3	04-11	n/a	96260-33204
B57	Sealing ring (teflon)	input shaft (rear)	2	04-11	n/a	96260-33404
E61	Sealing ring (teflon)	K2 housing (front)	1	04-11	n/a	96260-33604
E62	Sealing ring (teflon)	K2 housing (rear)	1	04-11	n/a	96260-33704
E64	Sealing ring (teflon)	output shaft (rear)	2	04-10	n/a	96260-33804
CLUTCH PLATES						
A70	Friction .080" 7.663" od 48T	B-1 brake clutch	4	04-11	185700-200	96260-35204
A71	Steel .079" 6.691" id 10T	B-1 brake clutch	3	04-11	185701-200	96260-37604
B73	Steel .078" 5.745" id 36T	K-3 clutch	5	04-11	185703-200	96260-37804
B73	Steel .126" 5.745" id 36T	K-3 clutch	sel	04-11	185703-320	96260-37904
B74	Friction .079" 6.711" od 36T	K-3 clutch	5	04-11	185702-200	96260-35404
C76	Steel .078" 5.888" id 36T	K-1 clutch	5	04-11	185709-200	96260-38004
C77	Friction .080" 6.499" od 40T	K-1 clutch	5	04-11	185708-200	96260-35604
D79	Friction .065" 6.812" od 50T	B-2 brake clutch	7	04-11	185704-170	96260-35804
D80	Steel .071" 6.274" id 24T	B-2 brake clutch	6	04-11	185705-180	96260-38204
E82	Friction .079" 5.388" od 42T	K-2 clutch	5	04-11	185706-200	96260-36004
E83	Steel .078" 4.496" id 36T	K-2 clutch	5	04-11	185707-200	96260-38404
PRESSURE PLATES						
A90	Pressure plate .179" (apply)	B-1 brale clutch	1	04-11	AE	96260-41103
A91	Pressure plate .155"	B-1 brale clutch	1	04-11	AE	96260-41403
B93	Pressure plate .164"	K-3 clutch	1	04-11	AE	96260-41703
C95	Pressure plate .196"	K-1 clutch	1	04-11	AE	96260-42103
D96	Pressure plate .248"	B-2 brake clutch	1	04-11	AE	96260-42403
D97	Pressure plate .196" (apply)	B-2 brake clutch	1	04-11	AE	96260-42703
E100	Pressure plate .181"	K-2 clutch	1	04-11	AE	96260-43403
FILTERS						
K9	Kit, filter	09D/TR60SN	1	04-11	AE	96260-44504
F110	Filter	09D/TR60SN	1	04-11	n/a	96260-45004
BUSHINGS						
K12	Kit, bushing	09D/TR60SN	1	04-11	n/a	96260-50104
B118	Bushing	K3 housing (rear)	1	04-11	n/a	96260-50904
B119	Bushing	front planetary	1	04-11	n/a	96260-51004
C121	Bushing	K1 housing	1	04-11	n/a	96260-51304
C124	Bushing	drive shell (inner/outer)	2	04-11	n/a	96260-51504
C125	Bushing	rear sun gear (front)	1	04-11	n/a	96260-51704
C126	Bushing	rear sun gear (rear)	1	04-11	n/a	96260-51804
D127	Bushing	rear planetary (front)	1	04-11	n/a	96260-52104
C128	Bushing	rear planetary (rear)	1	04-11	n/a	96260-52204

09D•TR-60SN

09D•TR60SN

ILL	DESCRIPTION	QTY	YEAR	REFERENCE #	PART #	
WASHERS/BEARINGS/RACES/SHIMS						
K13	Kit, thrust bearing	09D/TR60SN	1	04-11	n/a	96260-55104
A145	Bearing, caged	pump body	1	04-11	n/a	96260-56104
A147	Bearing, caged	pump support (rear)	1	04-11	n/a	96260-56204
B149	Washer, thrust (2-tabs plastic)	pump support to K3 housing	1	04-11	n/a	96260-56704
B150	Washer, thrust	K3 housing to planetary	1	04-11	n/a	96260-56804
B151	Washer, thrust (oil lube)	K3 housing to planetary	1	04-11	n/a	96260-56904
B153	Washer, thrust	input hub to planetary	1	04-11	n/a	96260-57004
B154	Race, thrust	front sun gear to hub	1	04-11	n/a	96260-57204
B155	Bearing, thrust	front sun gear to hub	1	04-11	n/a	96260-57304
B156	Race, thrust	front sun gear to hub	1	04-11	n/a	96260-57404
C158	Bearing, thrust	K1 housing to output hub	1	04-11	n/a	96260-57804
C159	Race, thrust	K1 housing to output hub	1	04-11	n/a	96260-57904
C161	Bearing, thrust	K1 hub to K1 housing	1	04-11	n/a	96260-58104
C162	Race, thrust	K1 hub to K1 housing	1	04-11	n/a	96260-58204
C163	Race, thrust	K1 hub to drive shell	1	04-11	n/a	96260-58404
C164	Bearing, thrust	K1 hub to drive shell	1	04-11	n/a	96260-58504
C165	Bearing, thrust	rear sun gear to drive shell	1	04-11	n/a	96260-58804
C166	Race, thrust	rear sun gear to drive shell	1	04-11	n/a	96260-58904
C170	Race, thrust	rear sun gear to planetary	1	04-11	n/a	96260-59104
C171	Bearing, thrust	rear sun gear to planetary	1	04-11	n/a	96260-59204
D175	Washer, thrust (6-tabs)	inner sprag race to planetary	1	04-11	n/a	96260-59304
D176	Race, thrust	rear planetary to K2 housing	1	04-11	n/a	96260-59504
D177	Bearing, thrust	rear planetary to K2 housing	1	04-11	n/a	96260-59604
D178	Race, thrust	rear planetary to K2 housing	1	04-11	n/a	96260-59704
E181	Race, thrust	K2 housing to output shaft	1	04-11	n/a	96260-60104
E182	Bearing, thrust	K2 housing to output shaft	1	04-11	n/a	96260-60204
E183	Race, thrust	K2 housing to output shaft	1	04-11	n/a	96260-60304
E184	Bearing, caged	output shaft	1	04-11	n/a	96260-60504
E185	Bearing, thrust	output shaft	1	04-11	n/a	96260-60704
E186	Race, thrust	output shaft	1	04-11	n/a	96260-60804
E190	Bearing, caged	case	1	04-11	n/a	96260-61004
F193	Bearing, ball	case	1	04-11	n/a	96260-61204
SNAP RINGS						
A213	Snap ring	B1 brake pressure plate	1	04-11	AE	96260-62503
B214	Snap ring	K3 clutch retainer	1	04-11	AE	96260-62803
B215	Snap ring	K3 clutch pressure plate	1	04-11	AE	96260-63003
B218	Snap ring	front ring gear to output hub	1	04-11	AE	96260-63303
C219	Snap ring	K1 clutch retainer	1	04-11	AE	96260-63503
C220	Snap ring	K1 clutch pressure plate	1	04-11	AE	96260-63803
D225	Snap ring	outer sprag in case	1	04-11	AE	96260-64003
D226	Snap ring	inner sprag race	1	04-11	AE	96260-64103
D227	Snap ring	inner sprag race	1	04-11	AE	96260-64203
D230	Snap ring	B2 brake pressure plate	1	04-11	AE	96260-64503
E231	Snap ring	K2 clutch pressure plate	1	04-11	AE	96260-64703
E233	Snap ring	K2 clutch retainer	1	04-11	AE	96260-64903
E235	Snap ring	output shaft	1	04-11	AE	96260-65103
E237	Snap ring	B2 clutch retainer	1	04-11	AE	96260-65303
F240	Snap ring	rear bearing	1	04-11	AE	96260-65503
PUMP PARTS AND PUMPS						
A250	Pump assembly	09D/TR60SN	1	04-11	AE	96260-67003
A251	Pump, body w/gears	09D/TR60SN	1	04-11	AE	96260-67503
A252	Gears, pump (inner/outer)	09D/TR60SN	1	04-11	n/a	96260-68104
A253	Support, pump (stator)	09D/TR60SN	1	04-11	AE	96260-68503

ILL	DESCRIPTION	QTY	YEAR	REFERENCE #	PART #	
HARD PARTS						
A270	Piston, B1 clutch	09D/TR60SN	1	04-11	AE	96260-72303
F272	Retainer, w/springs	B1 clutch	1	04-11	AE	96260-72403
A273	Plate, cushion	B1 clutch	1	04-11	AE	96260-72503
A275	Shield, oil lube (1-tab)	09D/TR60SN	1	04-11	AE	96260-72603
B278	Housing, K3 clutch	09D/TR60SN	1	04-11	AE	96260-73003
B279	Piston, K3 clutch	09D/TR60SN	1	04-11	AE	96260-73303
B280	Retainer, w/springs	K3 clutch	1	04-11	AE	96260-73403
B281	Piston, K3 clutch (balance)	09D/TR60SN	1	04-11	AE	96260-73503
B284	Gear, front sun (40T)	09D/TR60SN	1	04-11	AE	96260-74003
B285	Planetary, front (3-pinion 16T)	09D/TR60SN	1	04-11	AE	96260-74503
B287	Gear, front ring (72T)	09D/TR60SN	1	04-11	AE	96260-74903
B290	Shaft, input w/hub	09D/TR60SN (turbine shaft)	1	04-11	AE	96260-75203
C292	Housing, K1 clutch	09D/TR60SN	1	04-11	AE	96260-75503
C293	Piston, K1 clutch	09D/TR60SN	1	04-11	AE	96260-75803
C294	Retainer, w/springs	K1 clutch	1	04-11	AE	96260-75903
C295	Piston, K1 clutch (balance)	09D/TR60SN	1	04-11	AE	96260-76003
C300	Hub, K1 clutch	09D/TR60SN	1	04-11	AE	96260-76503
C301	Shell, drive (33T)	09D/TR60SN	1	04-11	AE	96260-76803
C302	Gear, sun gear 27T	09D/TR60SN	1	04-11	AE	96260-77203
D305	Race, inner sprag	09D/TR60SN	1	04-11	AE	96260-77503
D306	Planetary, rear (3 tall pinion 18T)	3 short pinion 17T	1	04-11	AE	96260-78003
D308	Gear, rear ring	09D/TR60SN	1	04-11	AE	96260-78303
E312	Piston, K2 clutch (balance)	09D/TR60SN	1	04-11	AE	96260-78503
E313	Piston, K2 clutch	09D/TR60SN	1	04-11	AE	96260-78703
E315	Housing, K2 clutch	09D/TR60SN	1	04-11	AE	96260-79003
E316	Shaft, output (AWD)	09D/TR60SN	1	04-11	AE	96260-79303
E317	Retainer, w/springs	B2 clutch	1	04-11	AE	96260-79503
E318	Piston, B2 clutch	09D/TR60SN	1	04-11	AE	96260-79703
F325	Housing, front (bell housing)	09D/TR60SN	1	04-11	AE	96260-80503
F326	Housing, main case	09D/TR60SN	1	04-11	AE	96260-80703
F330	Valve body w/solenoids	09D/TR60SN	1	04-11	AE	96260-84003
ELECTRICAL COMPONENTS						
F350	Sensor, input speed (TSS)	in pump (G182)	1	04-11	n/a	96260-85504
F352	Sensor, output speed (VSS)	09D/TR60SN (G195)	1	04-11	n/a	96260-85604
F351	Switch, neutral start (MLPS)	09D/TR60SN (F125)	1	04-11	n/a	96260-85704
F353	Sensor, pressure	09D/TR60SN (G93)	1	04-11	n/a	96260-85904
F354	Sensor, pressure	09D/TR60SN (G93)	1	04-11	n/a	96260-85904
F355	Harness, wiring (internal)	09D/TR60SN	1	04-11	n/a	96260-87004
F357	Harness, main wiring (internal)	09D/TR60SN	1	04-11	n/a	96260-87304
n/i	Solenoid	4-6 shift (N88)	1	04-11	n/a	96260-88004
n/i	Solenoid	B2 shift (N89)	1	04-11	n/a	96260-88104
n/i	Solenoid	K1 shift (N90)	1	04-11	n/a	96260-88204
n/i	Solenoid	TCC (modulation) (N91)	1	04-11	n/a	96260-88304
n/i	Solenoid	K3 shift (N92)	1	04-11	n/a	96260-88404
n/i	Solenoid	pressure control (EPC) (N93)	1	04-11	n/a	96260-88504
n/i	Solenoid	K2 shift (N282)	1	04-11	n/a	96260-88604
n/i	Solenoid	B1 shift	1	04-11	n/a	96260-88704
n/i	Sensor, transmission temperature	09D/TR60SN (TFT)	1	04-11	n/a	96260-85804
SPRAGS						
D370	Sprag	09D/TR60SN	1	04-11	n/a	96260-94104
D370	Sprag, w/inner/outer race	09D/TR60SN	1	04-11	AE	96260-94103
NOTES						

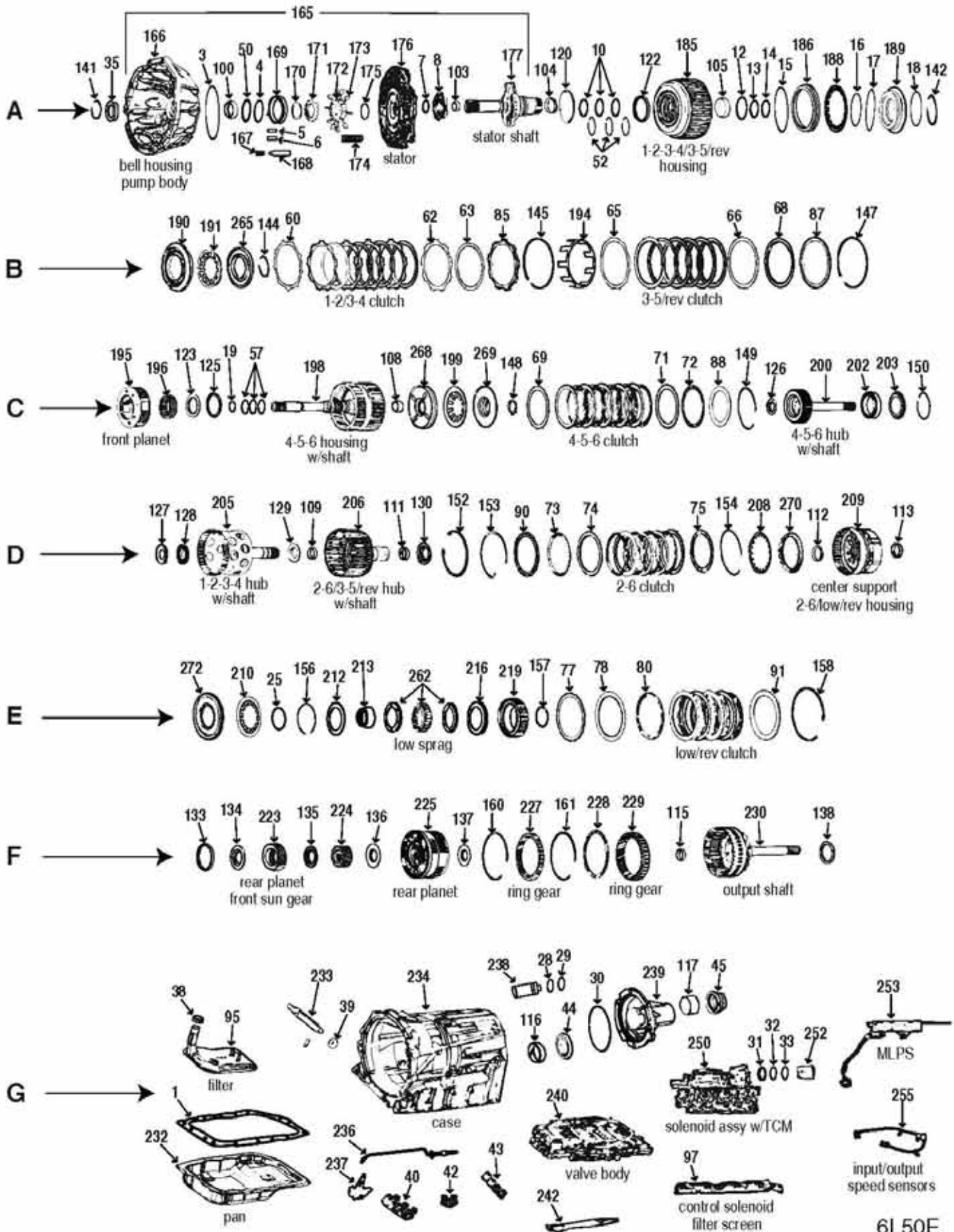

6L50E
10155-

ILL	DESCRIPTION	QTY	YEAR	REFERENCE #	PART #
REBUILDER KITS					
K5	Master kit w/steels w/pistons	1	06-11	AE	10155-11004
K5	Master kit w/steels w/o pistons	1	06-11	AE	10155-11104
K6	Master kit w/o steels w/pistons	1	06-11	AE	10155-12004
K6	Master kit w/o steels w/o pistons	1	06-11	AE	10155-12104
K7	O/H gasket set w/seals-rings w/pistons	1	06-11	APC-201901	10155-13004
K7	O/H gasket set w/seals-rings w/o pistons	1	06-11	FDB-2523	10155-13104
GASKETS AND RUBBER COMPONENTS					
G1	Gasket, pan (molded rubber) 6L45E/6L50E	1	06-11	FDB-B33355	10155-20104
METAL CLAD SEALS					
A35	Seal, metal clad 46.6x73/76x7.2/9.7 front pump	1	06-11	24224136	10150-30104
G45	Seal, metal clad extension housing (2WD)	1	06-11	FDB-B37101	10155-30404
SEALING RINGS					
K10	Kit, sealing ring 6L45E/6L50E	1	06-11	n/a	10155-31504
CLUTCH PLATES					
B60	Steel, waved plate 1-2/3-4 clutch	1	06-11	n/a	10155-40304
B62	Steel .069" 6.150" id 9T 1-2/3-4 clutch	5	06-11	24232652	10155-37604
B63	Friction .063" 6.690" od 36T 1-2/3-4 clutch	5	06-11	24233534	10155-35204
B65	Steel, waved plate 3-5/reverse clutch	1	06-11	n/a	10155-40504
B66	Steel .098" 6.370" id 36T 3-5/reverse clutch	4	06-11	24237663	10155-37804
B68	Friction .073" 7.180" od 36T 3-5/reverse clutch	4	06-11	24225569	10155-35304
C69	Steel, waved plate 4-5-6 clutch	1	06-11	n/a	10155-40604
C71	Friction .078" 4.130" id 36T (external) 4-5-6 clutch	6	06-11	24225575	10155-35704
C72	Friction .079" 4.940" od 36T (internal) 4-5-6 clutch	6	06-11	24225570	10155-35804
D73	Friction .099" 7.240" od 36T (internal) 2-6 clutch	5	06-11	24235454	10155-35904
D74	Friction .083" 6.350" id 24T (external) 2-6 clutch	5	06-11	24235455	10155-36004
D75	Steel, waved plate 2-6 clutch	1	06-11	n/a	10155-40704
E77	Steel, waved plate low/reverse clutch	1	06-11	n/a	10155-40804
E78	Steel .069" 6.210" id 24T low/reverse clutch	5	06-11	24232654	10155-38404
E80	Friction .063" 6.960" od 54T low/reverse clutch	5	06-11	24232654	10155-36104
PRESSURE PLATES					
B85	Pressure plate 1-2/3-4 clutch	1	06-11	AE	10155-41103
B87	Pressure plate 3-5/reverse clutch	1	06-11	AE	10155-41303
C88	Pressure plate 4-5-6 clutch	1	06-11	AE	10155-41603
D90	Pressure plate 2-6 clutch	1	06-11	AE	10155-42003
E91	Pressure plate low/reverse clutch	1	06-11	AE	10155-42503
FILTERS					
K9	Kit, filter Cadillac (6L45E/6L50E)	1	06-11	AE	10155-44504
K9	Kit, filter BMW X-5 (6L45E/6L50E)	1	06-09	AE	45155-44504
G95	Filter BMW X-5 (6L45E/6L50E)	1	07-09	24236595	45155-45104
G95	Filter 6L45E/6L50E	1	07-11	24236519	10155-45504
BUSHINGS					
K12	Kit, bushing 6L45E/6L50E	1	06-11	n/a	10155-50104
A100	Bushing pump body	1	06-11	n/a	10155-50604
A103	Bushing pump stator (front)	1	06-11	n/a	10155-50804
A104	Bushing pump stator (rear)	1	06-11	n/a	10155-50904
A105	Bushing 1-2-3-4 housing	1	06-11	n/a	10155-51004
C108	Bushing 4-5-6 housing	1	06-11	n/a	10155-51504
D109	Bushing 2-6/3-5 reverse hub (front)	1	06-11	n/a	10155-51804
D111	Bushing 2-6/3-5 reverse hub (rear)	1	06-11	n/a	10155-51804
D112	Bushing center support (front)	1	06-11	n/a	10155-52004
D113	Bushing center support (rear)	1	06-11	n/a	10155-52004
F115	Bushing output shaft (front)	1	06-11	n/a	10155-52304
G116	Bushing case	1	06-11	n/a	10155-52504

6L45E•6L50E

6L45E•6L50E

ILL	DESCRIPTION	QTY	YEAR	REFERENCE #	PART #
BUSHINGS (CONTINUED)					
G117	Bushing extension housing	1	06-11	n/a	10155-52804
WASHERS/BEARINGS/RACES/SHIMS					
A120	Washer, thrust stator to housing	1	06-11	n/a	10155-56304
A122	Bearing, caged 1-2-3-4/3-5/reverse housing	1	06-11	n/a	10155-56504
C123	Bearing, thrust front sun gear to housing	1	06-11	n/a	10155-56804
C125	Washer, thrust front planetary to housing	1	06-11	n/a	10155-57004
C126	Bearing, thrust 4-5-6 clutch hub	1	06-11	n/a	10155-57304
D127	Race, thrust 1-2-3-4 hub	1	06-11	n/a	10155-57504
D128	Bearing, thrust 1-2-3-4 hub	1	06-11	n/a	10155-57604
D129	Bearing, thrust 1-2-3-4 hub to 5/reverse hub	1	06-11	n/a	10155-57804
D130	Bearing, thrust 2-6/3-5/reverse hub	1	06-11	n/a	10155-58004
F133	Bearing, caged rear planetary	1	06-11	n/a	10155-58404
F134	Bearing, thrust front rear sun gear (front)	1	06-11	n/a	10155-58504
F135	Bearing, thrust front rear sun gear to rear sun gear	1	06-11	n/a	10155-58704
F136	Bearing, thrust rear sun gear tp planetary	1	06-10	n/a	10155-58804
F137	Bearing, thrust planetary to output shaft	1	06-11	n/a	10155-58904
F138	Bearing, thrust output shaft to case	1	06-11	n/a	10155-59004
SNAP RINGS					
A142	Snap ring 1-2-3-4 clutch retainer	1	06-11	AE	10155-62303
B144	Snap ring 1-2-3-4 clutch retainer	1	06-11	AE	10155-62403
B145	Snap ring 1-2-3-4 clutch pressure plate	1	06-11	AE	10155-62503
B147	Snap ring 3-5/reverse clutch pressure plate	1	06-11	AE	10155-62803
C148	Snap ring 4-5-6 clutch retainer	1	06-11	AE	10155-63103
C149	Snap ring 4-5-6 clutch pressure plate	1	06-11	AE	10155-63203
C150	Snap ring damper retainer	1	06-11	AE	10155-63503
D152	Snap ring center support to case	1	06-11	AE	10155-63803
D153	Snap ring 2-6 clutch pressure plate	1	06-11	AE	10155-64003
D154	Snap ring 2-6 clutch retainer	1	06-11	AE	10155-64303
E156	Snap ring low/reverse clutch retainer	1	06-10	AE	10155-64503
E157	Snap ring inner sprag race	1	06-11	AE	10155-64603
E158	Snap ring low/reverse clutch pressure plate	1	06-11	AE	10155-64903
F160	Snap ring ring gear in output shaft	1	06-11	AE	10155-65203
F161	Snap ring seat for ring gear	1	06-11	AE	10155-65503
PUMP PARTS AND PUMPS					
A165	Pump assembly 6L45E/6L50E	1	06-11	AE	10155-67003
A165	Pump assembly 6L45E/6L50E	1	07-09	AE	45155-67003
A167	Spring, pivot pin .038" .271" od .343" ol	1	06-11	AE	10150-68103
A168	Pin, pivot .308" od 1.265" ol	1	06-11	AE	10150-68203
A169	Slide, pump 17.948-17.960mm .706"	1	06-11	24222668	10150-68304
A169	Slide, pump 17.961-17.974mm .707"	1	06-11	24224131	10150-68404
A169	Slide, pump 17.975-17.987mm .708"	1	06-11	24224132	10150-68504
A170	Ring, pump vane .104" 2.627" od (solid)	1	06-11	n/a	10150-68604
A171	Guide, rotor (13 vane type) (4 tabs)	1	06-11	n/a	10150-68704
A172	Rotor, pump 17.948-17.960mm .706"	1	06-11	n/a	10150-68804
A172	Rotor, pump 17.961-17.974mm .707"	1	06-11	n/a	10150-68904
A172	Rotor, pump 17.975-17.987mm .708"	1	06-11	n/a	10150-69004
A173	Vane, pump .079" .534" w .706" oh	13	06-11	n/a	10150-69204
A174	Spring, pump slide .106" 1.911" oh	1	06-11	AE	10150-69303
A175	Ring, pump vane .104" 2.627" od (solid)	1	06-11	n/a	10150-68604
A176	Stator (pump cover)	1	06-11	AE	10155-69503
A177	Shaft, stator	1	06-11	AE	10155-69703

ILL	DESCRIPTION	QTY	YEAR	REFERENCE #	PART #	
HARD PARTS						
A185	Housing, 1-2-3-4 clutch	3-5/reverse	1	06-11	AE	10155-72303
A186	Piston, 1-2-3-4 clutch	3-5/reverse	1	06-11	AE	10155-72503
A188	Spring, diaphragm	1-2-3-4/3-5/reverse clutch	1	06-11	AE	10155-72603
A189	Piston, (balance)	1-2-3-4/3-5/reverse clutch	1	06-11	AE	10155-72703
B190	Piston, 1-2-3-4 clutch	6L45E/6L50E	1	06-11	AE	10155-72803
B191	Spring, diaphragm	1-2-3-4 clutch	1	06-11	AE	10155-72903
B194	Ring, apply	1-2-3-4 clutch	1	06-11	AE	10155-73403
C195	Planetary, front	6L45E/6L50E	1	06-11	AE	10155-73703
C196	Gear, front sun	6L45E/6L50E	1	06-11	AE	10155-74003
C198	Housing, 4-5-6 clutch w/shaft	6L45E/6L50E	1	06-11	AE	10155-74303
C199	Spring, diaphragm	4-5-6 clutch	1	06-11	AE	10155-74503
C200	Hub 4-5-6 clutch w/shaft	6L45E/6L50E	1	06-11	AE	10155-74703
C202	Damper	6L45E/6L50E	1	06-11	AE	10155-74903
C203	Retainer, damper	6L45E/6L50E	1	06-11	AE	10155-75003
D205	Hub, 1-2-3-4 clutch w/shaft	6L45E/6L50E	1	06-11	AE	10155-75503
D206	Hub, 2-6/3-5/reverse hub w/shaft	6L45E/6L50E	1	06-11	AE	10155-75803
D208	Spring, diaphragm	2-6 clutch	1	06-11	AE	10155-76003
D209	Support, center	2-6/low/reverse clutch housing	1	06-11	AE	10155-76503
E210	Spring, diaphragm	low/reverse clutch	1	06-11	AE	10155-76803
E212	Retainer, low sprag	6L45E/6L50E	1	06-11	AE	10155-76903
E213	Race, inner sprag	6L45E/6L50E	1	06-11	AE	10155-77103
E216	Retainer, low sprag	6L45E/6L50E	1	06-11	AE	10155-76903
E219	Race, outer sprag	low/reverse clutch hub	1	06-11	AE	10155-77503
F223	Gear, front sun	6L45E/6L50E	1	06-11	AE	10155-77803
F224	Gear, rear sun	6L45E/6L50E	1	03-11	AE	10155-78103
F225	Planetary, rear	6L45E/6L50E	1	06-11	AE	10155-78503
F227	Gear, ring	6L45E/6L50E	1	06-11	AE	10155-78803
F228	Spacer, rear ring gear	6L45E/6L50E	1	06-11	AE	10155-79003
F229	Gear, rear ring	6L45E/6L50E	1	06-11	AE	10155-79103
F230	Shaft, output	6L45E/6L50E	1	06-11	AE	10155-79303
G232	Pan, bottom	6L45E/6L50E	1	06-11	AE	10155-79403
G233	Shaft, shift	6L45E/6L50E	1	06-11	AE	10155-79903
G234	Housing, main case	6L45E/6L50E	1	06-11	AE	10155-80103
G236	Rod, park	6L45E/6L50E	1	06-11	AE	10155-80503
G237	Cone, rooster	6L45E/6L50E	1	06-11	AE	10155-80603
G239	Housing, extension (2WD)	6L45E/6L50E	1	06-11	AE	10155-81003
G239	Housing, extension (4WD)	adapter	1	06-11	AE	10155-81103
G240	Valve body assembly (w/solenoids)	6L45E/6L50E	1	06-11	AE	10155-81503
ELECTRICAL COMPONENTS						
G250	Solenoid, w/TCM assembly	6L45E/6L50E	1	06-11	n/a	10155-85404
G250	Solenoid, w/TCM assembly	6L45E	1	07-09	n/a	45155-85404
G252	Connector, wiring	6L45E/6L50E	1	06-11	n/a	10155-86004
G255	Switch, manual lever position	6L45E/6L50E	1	06-11	n/a	10155-86504
G255	Sensor, w/harness	input	1	06-11	n/a	10155-87504
G255	Sensor, w/harness	output	1	06-11	n/a	10155-87604
SPRAGS						
E262	Sprag, low	6L45E/6L50E	1	06-11	n/a	10155-94204
BONDED PISTONS						
B265	Piston, bonded rubber	1-2-3-4 clutch	1	06-11	n/a	10155-96304
C268	Piston, bonded rubber	4-5-6 clutch	1	06-11	n/a	10155-96504
C268	Piston, bonded rubber (balance)	4-5-6 clutch	1	06-11	n/a	10155-96804
D270	Piston, bonded rubber	low/reverse clutch	1	06-11	n/a	10155-97004
E272	Piston, bonded rubber (balance)	low/reverse clutch	1	06-11	n/a	10155-97304

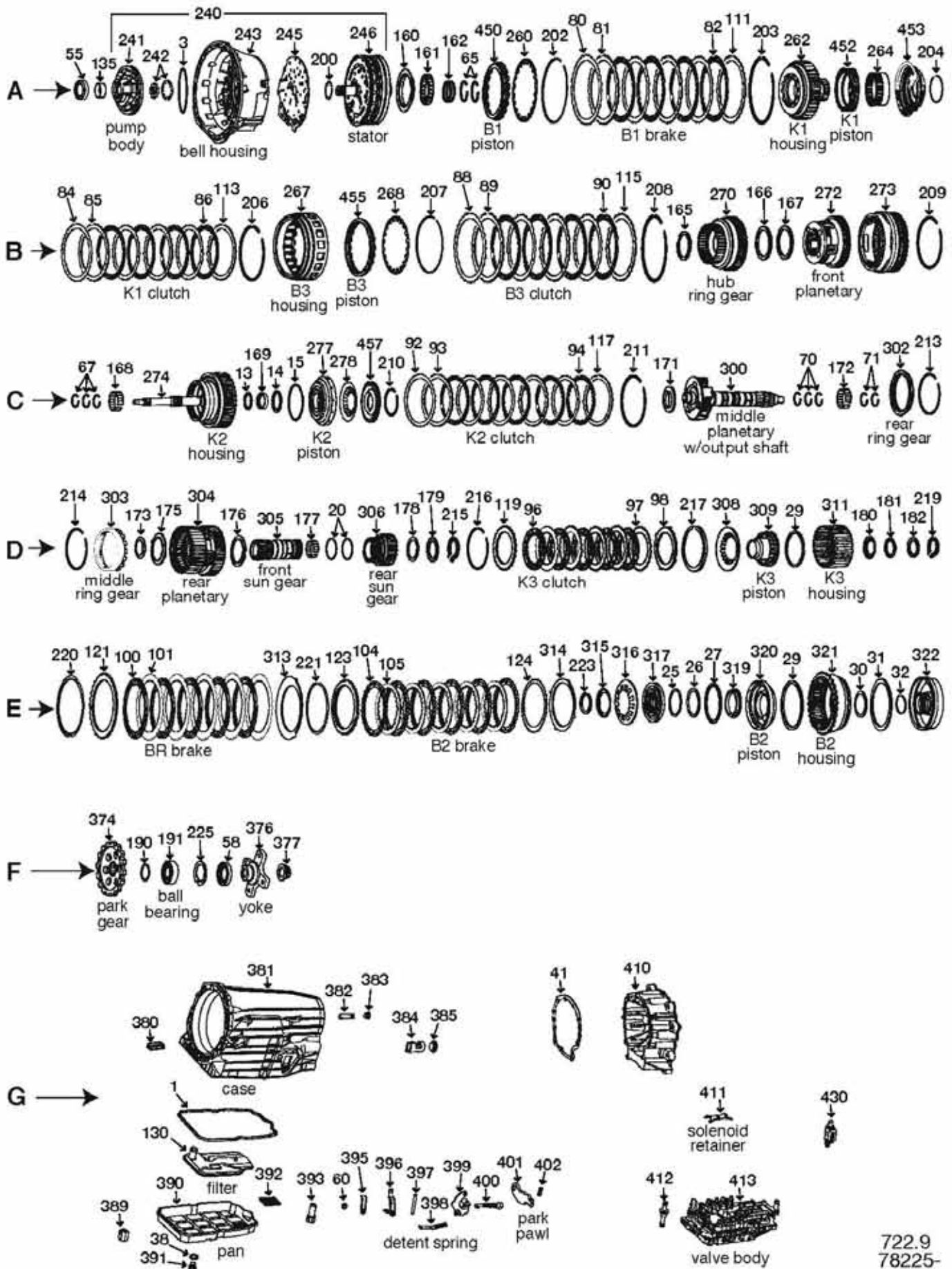

722.9
78225-

ILL	DESCRIPTION		QTY	YEAR	REFERENCE #	PART #
REBUILDER KITS						
K5	Master kit w/steels w/pistons	w/intermediate plate/extension gasket	1	05-11	AE	78225-11004
K5	Master kit w/steels w/o pistons	w/intermediate plate/extension gasket	1	05-11	AE	78225-11104
K5	Master kit w/steels w/pistons	w/o intermediate plate/extension gasket	1	05-11	AE	78225-11204
K5	Master kit w/steels w/o pistons	w/o intermediate plate/extension gasket	1	05-11	AE	78225-11304
K6	Master kit w/o steels w/pistons	w/intermediate plate/extension gasket	1	05-11	AE	78225-12004
K6	Master kit w/o steels w/o pistons	w/intermediate plate/extension gasket	1	05-11	AE	78225-12104
K6	Master kit w/o steels w/pistons	w/o intermediate plate/extension gasket	1	05-11	AE	78225-12204
K6	Master kit w/o steels w/o pistons	w/o intermediate plate/extension gasket	1	05-11	AE	78225-12304
K7	O/H gasket set w/seals-rings w/pistons	w/intermediate plate/extension gasket	1	05-11	n/a	78225-13004
K7	O/H gasket set w/seals-rings w/o pistons	w/intermediate plate/extension gasket	1	05-11	FDB-2533	78225-13104
K7	O/H gasket set w/seals-rings w/pistons	w/o intermediate plate/extension gasket	1	05-11	n/a	78225-13204
K7	O/H gasket set w/seals-rings w/o pistons	w/o intermediate plate/extension gasket	1	05-11	FDB-2536	78225-13304
GASKETS AND RUBBER COMPONENTS						
G1	Gasket, pan (molded rubber)	722.9	1	05-11	FDB-B22294	78225-20104
G41	Gasket, extension housing	722.9	1	05-11	FDB-B10386	78225-29004
METAL CLAD SEALS						
A55	Seal, metal clad	front	1	05-11	FDB-B29257	55206
F58	Seal, metal clad	extension housing (2WD)	1	05-11	FDB-B29258	78223-30104
F58	Seal, metal clad	adapter housing (4WD)	1	05-11	FDB-B37131	78225-30804
G60	Seal, metal clad	shift shaft	1	05-11	006-997-01-47	55210
SEALING RINGS						
K10	Kit, sealing ring	722.9	1	05-11	FDB-3525	78225-31504
CLUTCH PLATES						
A80	Steel, waved plate	B-1 brake clutch	1	05-11	n/a	78225-40104
A81	Friction .082" 6.710" id 18T external T	B-1 brake clutch (1-sided)	4	05-11	189701-208	78225-35204
A82	Friction .082" 7.495" id 36T internal T	B-1 brake clutch (1-sided)	4	05-11	189700-208	78225-35304
B84	Steel, waved plate	K-1 clutch	1	05-11	n/a	78225-40204
B85	Friction .075" 5.023" id 36T external T	K-1 clutch (1-sided)	4	05-11	189711-190	78225-35604
B86	Friction .073" 5.843" id 30T internal T	K-1 clutch (1-sided)	4	05-11	189710-185	78225-35704
B88	Steel, waved plate	B-3 clutch	1	05-11	n/a	78225-40104
B89	Friction .082" 6.710" id 18T external T	B-3 clutch (1-sided)	4	05-11	189701-208	78225-35204
B90	Friction .082" 7.495" id 36T internal T	B-3 clutch (1-sided)	4	05-11	189700-208	78225-35304
C92	Steel, waved plate	K-2 brake clutch	1	05-11	n/a	78225-40304
C93	Friction .082" 6.009" id 30T external T	K-2 clutch (1-sided)	5	05-11	220-272-0726	78225-36204
C94	Friction .082" 6.591" id 36T internal T	K-2 clutch (1-sided)	5	05-11	220-272-0225	78225-36304
D96	Friction .082" 4.486" od 24T internal T	K-3 clutch (1-sided)	5	05-11	141708A-208	20223-36404
D97	Friction .083" 3.465" id 24T external T	K-3 clutch (1-sided)	5	05-11	141709A-211	20223-36504
D98	Steel, waved plate	K-3 clutch	1	05-11	n/a	78225-40404
E100	Friction .063" 7.085" od 46T	BR brake clutch	5	05-11	141704-160	78223-36804
E101	Steel .071" 6.100" id 30T	BR brake clutch	5	05-11	141705-180	78223-40004
E104	Friction .063" 5.219" od 40 external teeth	B-2 brake clutch	6	05-11	220-272-1726	78223-37004
E105	Steel .071" 6.097" id 24 internal teeth	B-2 brake clutch	5	05-11	140-272-0425	78223-40504
E124	Steel, waved plate	B-2 brake clutch	1	05-11	AE	78225-40504
PRESSURE PLATES						
A111	Pressure plate	B-1 brake clutch	1	05-11	AE	78225-41103
B113	Pressure plate	K-1 clutch	1	05-11	AE	78225-41303
B115	Pressure plate	B-3 clutch	1	05-11	AE	78225-41103
C117	Pressure plate	K-2 clutch	1	05-11	AE	78225-41603
D119	Pressure plate .155" 3.465" id 24T	K-3 clutch	1	05-11	AE	78223-42003
FILTERS						
K9	Kit, filter	722.9	1	05-11	AE	78225-44504
G130	Filter, oil	722.9	1	05-08	221-277-0395	78224-45104

722.9

722.9

ILL	DESCRIPTION	QTY	YEAR	REFERENCE #	PART #
BUSHINGS					
A135	Bushing pump body	1	05-11	n/a	78225-50604
PUMP PARTS AND PUMPS					
A241	Body, pump w/gears	722.9	1	05-11	AE 78225-67003
A246	Support, pump (stator assembly)	722.9	1	05-11	AE 78225-68503
HARD PARTS					
A245	Plate, pump (plated)	722.9	1	05-11	FDB-B10385 78225-72604
G390	Pan, bottom	722.9	1	05-11	AE 78225-80303
G413	Valve body w/solenoids	722.9	1	05-11	AE 78225-83503
ELECTRICAL COMPONENTS					
n/i	Module electric control	1	05-11	n/a	78225-85504
n/i	Module transmission control	1	05-11	n/a	78225-85604
n/i	Solenoid pressure control	1	05-11	n/a	78225-85804
n/i	Solenoid K-1 clutch	1	05-11	n/a	78225-85904
n/i	Solenoid K-2 clutch	1	05-11	n/a	78225-86004
n/i	Solenoid K-3 clutch	1	05-11	n/a	78225-86104
n/i	Solenoid B-1 brake clutch	1	05-11	n/a	78225-86204
n/i	Solenoid B-2 brake clutch	1	05-11	n/a	78225-86304
n/i	Solenoid B-3 brake clutch	1	05-11	n/a	78225-86404
n/i	Solenoid TCC	1	05-11	n/a	78225-86504
n/i	Sensor turbine speed	1	05-11	n/a	78225-87104
n/i	Sensor internal RPM	1	05-11	n/a	78225-87204
n/i	Sensor output RPM	1	05-11	n/a	78225-87304
n/i	Sensor range selection	1	05-11	n/a	78225-87404
BONDED PISTONS					
A450	Piston, bonded rubber B-1 brake clutch	1	05-11	n/a	78225-96204
A452	Piston, bonded rubber K-1 clutch	1	05-11	n/a	78225-96404
A453	Piston, bonded rubber (balance) K-1 clutch	1	05-11	n/a	78225-96504
B455	Piston, bonded rubber B-3 clutch	1	05-11	n/a	78225-96704
C457	Piston, bonded rubber (balance) K-2 clutch	1	05-11	n/a	78225-97004
NOTES					

DECIMAL & MILLIMETER EQUIVALENTS

FRACTION	DECIMAL	MILLIMETER	FRACTION	DECIMAL	MILLIMETER
1/64	0.015625	0.397	33/64	.515625	13.097
1/32	.03125	0.794	17/32	.53125	13.494
3/64	.046875	1.191	25/64	.546875	13.891
1/16	.0625	1.588	9/16	.5625	14.288
5/64	.078125	1.984	37/64	.578125	14.684
3/32	.09375	2.381	19/32	.59375	15.081
7/64	.109375	2.778	39/64	.609375	15.478
1/8	.1250	3.175	5/8	.6250	15.875
9/64	.140625	3.572	41/64	.640625	16.272
5/32	.15625	3.969	21/32	.65625	16.669
11/64	.171875	4.366	43/64	.671875	17.066
3/16	.1875	4.763	11/16	.6875	17.463
13/64	.203125	5.159	45/64	.703125	17.859
7/32	.21875	5.556	23/32	.71875	18.256
15/64	.234375	5.593	47/64	.734375	18.653
1/4	.2500	6.350	3/4	.7500	19.050
17/64	.265625	6.747	49/64	.765625	19.447
9/32	.28125	7.144	25/32	.78125	19.844
19/64	.296875	7.541	51/64	.796875	20.241
5/16	.3125	7.938	13/16	.8125	20.638
21/64	.328125	8.334	53/64	.828125	21.034
11/32	.34375	8.731	27/32	.84375	21.431
23/64	.359375	9.128	55/64	.859375	21.828
3/8	.3750	9.525	7/8	.8750	22.225
25/64	.390625	9.922	57/64	.890625	22.622
13/32	.40625	10.319	29/32	.90625	23.019
27/64	.421875	10.716	59/64	.921875	23.416
7/16	.4375	11.113	15/16	.9375	23.813
29/64	.453125	11.509	61/64	.953125	24.209
15/32	.46875	11.906	31/32	.96875	24.606
31/64	.484375	12.303	63/64	.984375	25.003
1/2	.5000	12.700	1	1.000	25.400

MILLIMETER TO DECIMAL EQUIVALENCES

MM	INCHES	MM	INCHES	MM	INCHES	MM	INCHES	MM	INCHES	MM	INCHES
.1	.0039	11	.4331	30	1.1811	49	1.9291	68	2.6772	87	3.4252
.2	.0079	12	.4724	31	1.2205	50	1.9685	69	2.7165	88	3.4649
.3	.0118	13	.5118	32	1.2598	51	2.0079	70	2.7559	89	3.5039
.4	.0157	14	.5512	33	1.2992	52	2.0472	71	2.7953	90	3.5433
.5	.0197	15	.5906	34	1.3386	53	2.0866	72	2.8346	91	3.5827
.6	.0236	16	.6299	35	1.3780	54	2.1260	73	2.8740	92	3.6220
.7	.0276	17	.6693	36	1.4173	55	2.1654	74	2.9134	93	3.6614
.8	.0315	18	.7087	37	1.4567	56	2.2047	75	2.9528	94	3.7008
.9	.0354	19	.7480	38	1.4961	57	2.2441	76	2.9921	95	3.7402
1	.0394	20	.7874	39	1.5354	58	2.2835	77	3.0315	96	3.7795
2	.0787	21	.8268	40	1.5748	59	2.3228	78	3.0709	97	3.8189
3	.1181	22	.8661	41	1.6142	60	2.3622	79	3.1102	98	3.8583
4	.1575	23	.9055	42	1.6535	61	2.4016	80	3.1496	99	3.8976
5	.1969	24	.9449	43	1.6929	62	2.4409	81	3.1890	100	3.9370
6	.2362	25	.9843	44	1.7323	63	2.4803	82	3.2283		
7	.2756	26	1.0236	45	1.7717	64	2.5197	83	3.2677		
8	.3150	27	1.0630	46	1.8110	65	2.5591	84	3.3071		
9	.3543	28	1.1024	47	1.8504	66	2.5984	85	3.3465		
10	.3937	29	1.1417	48	1.8898	67	2.6378	86	3.3858		

COPYRIGHT © 2011 AUTRY ENTERPRISES LTD.

ILL	DESCRIPTION		QTY	YEAR	REFERENCE #	PART #
REBUILDER KITS						
K5	Master kit w/steels	PN3A	1	09-11	n/a	60273-11104
K6	Master kit w/o steels	PN3A	1	09-11	n/a	60273-12104
K7	O/H gasket set w/seals-rings	PN3A	1	09-11	n/a	60273-13104
FILTERS						
n/i	Filter	PN3A	1	09-11	n/a	60273-45004
NOTES						

PN3A

PN4A

PN4A

ILL	DESCRIPTION		QTY	YEAR	REFERENCE #	PART #
REBUILDER KITS						
K5	Master kit w/steels	PN4A	1	09-11	n/a	60274-11104
K6	Master kit w/o steels	PN4A	1	09-11	n/a	60274-12104
K7	O/H gasket set w/seals-rings	PN4A	1	09-11	n/a	60274-13104
FILTERS						
n/i	Filter	PN4A	1	09-11	n/a	60274-45004
NOTES						

ILL	DESCRIPTION	QTY	YEAR	REFERENCE #	PART #
REBUILDER KITS					
K5	Master kit w/steels PSFA	1	09-11	n/a	60275-11104
K6	Master kit w/o steels PSFA	1	09-11	n/a	60275-12104
K7	O/H gasket set w/seals-rings PSFA	1	09-11	n/a	60275-13104
FILTERS					
n/i	Filter PSFA	1	09-11	n/a	60275-45004
NOTES					

PSFA



Automatic Transmission Parts Replacement Catalog

Limited Warranty

All products supplied are guaranteed to be free from manufacturing defects for 1 year or 12,000 miles, whichever comes first. Any and all parts claimed to be defective must be returned freight prepaid for inspection. Warranty is limited to the replacement of parts only. We will not honor claims for labor or other damages that may occur.

This warranty does not apply to any product that has been misused, altered in any way, or subjected to excessive operating conditions beyond the manufacturer's control, specifications, or instructions. All returns must have prior company approval and authorization.

Important Notice

While the utmost care has been used in compiling reliable information in this catalog, we cannot assume any responsibility for errors, omissions, the inaccuracy of data or misapplications supplied to us. All parts shown within are intended for replacement purposes only. The use of original equipment manufacturer's part number and terminology is solely for the purpose of clarification and to help simplify selection for the proper replacement part.

NEW PART NO 50185

BorgWarner PART NO. 50185

OEM Heavy Duty Replacement
Governor Pressure Solenoid fits
Dodge/Jeep 42/44/46/47/48 RE transmissions



BorgWarner carries a full line of OEM quality clutch plates, transmission bands, one-way clutches, and electronic transmission solenoids that are 100% guaranteed to fit your rebuilds.

We're stable under pressure.

BorgWarner's new Governor Pressure Solenoid will not flood out at increased line pressures and can be used in modified and high performance transmissions as well as stock units. It delivers all the benefit of much more expensive aftermarket solenoid adapter kits for just the price of a solenoid, and with better reliability and no extra parts to change out.

The extra size gives you more **magnet force, more spool valve force, 15% more flow capacity than the OE brand**, all of which adds up to a wide safety margin of stable pressure to ensure reliable shifting under all conditions.

Call your authorized distributor today and ask for genuine OEM quality solenoids from the global leader in automatic transmission technology...BorgWarner Inc.



The BorgWarner Indianapolis 500 Trophy is a registered trademark of BorgWarner Inc.



Check out this rebuilding tool.

It's convenient, informative
and free!

*New!
Online
Catalog*



Technical Inserts

Inside TransTec® kits you'll find technical literature with illustrations that simplify rebuilding transmissions.



Technical Bulletins

Written by transmission professionals for transmission professionals to clear up confusion and simplify rebuilding complex transmissions.

Online Transmission Catalog Now Available!

Check out the online version of the TransTec® transmission catalog. You'll find the latest kits and components with daily updates.



www.TransTec.com

Visit www.TransTec.com and you'll find feature-rich resources like our new Online Transmission Catalog with the latest kits and components, technical information organized by transmission, a Transmission-by-Vehicle Guide, New Product Announcements, Technical Bulletins and more. The days of searching through piles of papers and manuals are a thing of the past.

Simply click on the type of reference material you want and view them on screen or download them for printing.

So take a close look at www.TransTec.com and see what we have to offer. You'll find this convenient, informative tool is indispensable.

*Includes
Global
Applications*



Transmission Guide

This convenient reference, now available on-line, makes it easy to determine which automatic transmission is in a specific domestic or import vehicle.



New Product Announcements

advise of the latest developments in rebuilding.



TRANstec®

We make it Easy.

T: 419.499.2502 • F: 419.499.2804 • www.TransTec.com • Milan, OH 44846



A Division of Freudenberg-NOK